



VIRGINIA

REGISTER OF REGULATIONS

VOL. 29 ISS. 24

PUBLISHED EVERY OTHER WEEK BY THE VIRGINIA CODE COMMISSION

JULY 29, 2013

TABLE OF CONTENTS

Register Information Page	2993
Publication Schedule and Deadlines	2994
Petitions for Rulemaking	2995
Notices of Intended Regulatory Action	2997
Regulations	2998
1VAC20-50. Candidate Qualification (Final).....	2998
2VAC5-685. Regulations Governing Pesticide Applicator Certification under Authority of Virginia Pesticide Control Act (Fast-Track).....	3000
4VAC25-140. Coal Surface Mining Regulations (Final).....	3004
6VAC15-40. Minimum Standards for Jails and Lockups (Proposed).....	3004
8VAC20-22. Licensure Regulations for School Personnel (Final).....	3006
9VAC5-10. General Definitions (Final).....	3009
9VAC5-170. Regulation for General Administration (Final).....	3009
9VAC5-20. General Provisions (Final).....	3017
9VAC5-40. Existing Stationary Sources (Final).....	3017
9VAC5-50. New and Modified Stationary Sources (Final).....	3039
9VAC5-91. Regulations for the Control of Motor Vehicle Emissions in the Northern Virginia Area (Final).....	3044
9VAC15-70. Small Renewable Energy Projects (Combustion) Permit by Rule (Final).....	3067
9VAC25-31. Virginia Pollutant Discharge Elimination System (VPDES) Permit Regulation (Final).....	3075
9VAC25-32. Virginia Pollution Abatement (VPA) Permit Regulation (Final).....	3075
9VAC25-220. Surface Water Management Area Regulation (Final).....	3075
9VAC25-230. Procedural Rule No. 1 - Public and Formal Hearing Procedures (Final).....	3075
9VAC25-20. Fees for Permits and Certificates (Final).....	3085
9VAC25-31. Virginia Pollutant Discharge Elimination System (VPDES) Permit Regulation (Final).....	3085
9VAC25-32. Virginia Pollution Abatement (VPA) Permit Regulation (Final).....	3085
10VAC5-161. Mortgage Loan Originators (Proposed).....	3236
12VAC5-585. Biosolids Use Regulations (Final).....	3240
12VAC30-60. Standards Established and Methods Used to Assure High Quality Care (Fast-Track).....	3240
12VAC35-220. Certification Requirements for Early Intervention Professionals and Early Intervention Specialists (Fast-Track).....	3242
13VAC5-31. Virginia Amusement Device Regulations (Proposed).....	3246
13VAC5-51. Virginia Statewide Fire Prevention Code (Proposed).....	3252
13VAC5-63. Virginia Uniform Statewide Building Code (Proposed).....	3282
13VAC5-91. Virginia Industrialized Building Safety Regulations (Proposed).....	3416
18VAC15-40. Virginia Certified Home Inspectors Regulations (Notice of Objection to Fast-Track Rulemaking).....	3422
18VAC90-20. Regulations Governing the Practice of Nursing (Emergency).....	3422
24VAC20-60. Virginia Commercial Driver's License Regulations (Final).....	3425
24VAC20-90. Evidence Required to Permit Registration or Reregistration of Vehicles for Which Proof of Tax Payment and of State Corporation Commission Registration is Required (Fast-Track).....	3425
General Notices/Errata	3427

Virginia Code Commission

<http://register.dls.virginia.gov>

THE VIRGINIA REGISTER INFORMATION PAGE

THE VIRGINIA REGISTER OF REGULATIONS is an official state publication issued every other week throughout the year. Indexes are published quarterly, and are cumulative for the year. The *Virginia Register* has several functions. The new and amended sections of regulations, both as proposed and as finally adopted, are required by law to be published in the *Virginia Register*. In addition, the *Virginia Register* is a source of other information about state government, including petitions for rulemaking, emergency regulations, executive orders issued by the Governor, and notices of public hearings on regulations.

ADOPTION, AMENDMENT, AND REPEAL OF REGULATIONS

An agency wishing to adopt, amend, or repeal regulations must first publish in the *Virginia Register* a notice of intended regulatory action; a basis, purpose, substance and issues statement; an economic impact analysis prepared by the Department of Planning and Budget; the agency's response to the economic impact analysis; a summary; a notice giving the public an opportunity to comment on the proposal; and the text of the proposed regulation.

Following publication of the proposal in the *Virginia Register*, the promulgating agency receives public comments for a minimum of 60 days. The Governor reviews the proposed regulation to determine if it is necessary to protect the public health, safety and welfare, and if it is clearly written and easily understandable. If the Governor chooses to comment on the proposed regulation, his comments must be transmitted to the agency and the Registrar no later than 15 days following the completion of the 60-day public comment period. The Governor's comments, if any, will be published in the *Virginia Register*. Not less than 15 days following the completion of the 60-day public comment period, the agency may adopt the proposed regulation.

The Joint Commission on Administrative Rules (JCAR) or the appropriate standing committee of each house of the General Assembly may meet during the promulgation or final adoption process and file an objection with the Registrar and the promulgating agency. The objection will be published in the *Virginia Register*. Within 21 days after receipt by the agency of a legislative objection, the agency shall file a response with the Registrar, the objecting legislative body, and the Governor.

When final action is taken, the agency again publishes the text of the regulation as adopted, highlighting all changes made to the proposed regulation and explaining any substantial changes made since publication of the proposal. A 30-day final adoption period begins upon final publication in the *Virginia Register*.

The Governor may review the final regulation during this time and, if he objects, forward his objection to the Registrar and the agency. In addition to or in lieu of filing a formal objection, the Governor may suspend the effective date of a portion or all of a regulation until the end of the next regular General Assembly session by issuing a directive signed by a majority of the members of the appropriate legislative body and the Governor. The Governor's objection or suspension of the regulation, or both, will be published in the *Virginia Register*. If the Governor finds that changes made to the proposed regulation have substantial impact, he may require the agency to provide an additional 30-day public comment period on the changes. Notice of the additional public comment period required by the Governor will be published in the *Virginia Register*.

The agency shall suspend the regulatory process for 30 days when it receives requests from 25 or more individuals to solicit additional public comment, unless the agency determines that the changes have minor or inconsequential impact.

A regulation becomes effective at the conclusion of the 30-day final adoption period, or at any other later date specified by the promulgating agency, unless (i) a legislative objection has been filed, in which event the regulation, unless withdrawn, becomes effective on the date specified, which shall be after the expiration of the 21-day objection period; (ii) the Governor exercises his authority to require the agency to provide for additional public comment, in which event the regulation,

unless withdrawn, becomes effective on the date specified, which shall be after the expiration of the period for which the Governor has provided for additional public comment; (iii) the Governor and the General Assembly exercise their authority to suspend the effective date of a regulation until the end of the next regular legislative session; or (iv) the agency suspends the regulatory process, in which event the regulation, unless withdrawn, becomes effective on the date specified, which shall be after the expiration of the 30-day public comment period and no earlier than 15 days from publication of the readopted action.

A regulatory action may be withdrawn by the promulgating agency at any time before the regulation becomes final.

FAST-TRACK RULEMAKING PROCESS

Section 2.2-4012.1 of the Code of Virginia provides an exemption from certain provisions of the Administrative Process Act for agency regulations deemed by the Governor to be noncontroversial. To use this process, Governor's concurrence is required and advance notice must be provided to certain legislative committees. Fast-track regulations will become effective on the date noted in the regulatory action if no objections to using the process are filed in accordance with § 2.2-4012.1.

EMERGENCY REGULATIONS

Pursuant to § 2.2-4011 of the Code of Virginia, an agency, upon consultation with the Attorney General, and at the discretion of the Governor, may adopt emergency regulations that are necessitated by an emergency situation. An agency may also adopt an emergency regulation when Virginia statutory law or the appropriation act or federal law or federal regulation requires that a regulation be effective in 280 days or less from its enactment. The emergency regulation becomes operative upon its adoption and filing with the Registrar of Regulations, unless a later date is specified. Emergency regulations are limited to no more than 18 months in duration; however, may be extended for six months under certain circumstances as provided for in § 2.2-4011 D. Emergency regulations are published as soon as possible in the *Register*. During the time the emergency status is in effect, the agency may proceed with the adoption of permanent regulations through the usual procedures. To begin promulgating the replacement regulation, the agency must (i) file the Notice of Intended Regulatory Action with the Registrar within 60 days of the effective date of the emergency regulation and (ii) file the proposed regulation with the Registrar within 180 days of the effective date of the emergency regulation. If the agency chooses not to adopt the regulations, the emergency status ends when the prescribed time limit expires.

STATEMENT

The foregoing constitutes a generalized statement of the procedures to be followed. For specific statutory language, it is suggested that Article 2 (§ 2.2-4006 et seq.) of Chapter 40 of Title 2.2 of the Code of Virginia be examined carefully.

CITATION TO THE VIRGINIA REGISTER

The *Virginia Register* is cited by volume, issue, page number, and date. **29:5 VA.R. 1075-1192 November 5, 2012**, refers to Volume 29, Issue 5, pages 1075 through 1192 of the *Virginia Register* issued on November 5, 2012.

The Virginia Register of Regulations is published pursuant to Article 6 (§ 2.2-4031 et seq.) of Chapter 40 of Title 2.2 of the Code of Virginia.

Members of the Virginia Code Commission: **John S. Edwards**, Chairman; **Gregory D. Habeeb**; **James M. LeMunyon**; **Ryan T. McDougle**; **Robert L. Calhoun**; **E.M. Miller, Jr.**; **Thomas M. Moncure, Jr.**; **Wesley G. Russell, Jr.**; **Charles S. Sharp**; **Robert L. Taverner**; **Christopher R. Nolen**; **J. Jasen Eige** or **Jeffrey S. Palmore**.

Staff of the Virginia Register: **Jane D. Chaffin**, Registrar of Regulations; **Karen Perrine**, Assistant Registrar; **Anne Bloomsburg**, Regulations Analyst; **Rhonda Dyer**, Publications Assistant; **Terri Edwards**, Operations Staff Assistant.

PUBLICATION SCHEDULE AND DEADLINES

This schedule is available on the *Register's* Internet home page (<http://register.dls.virginia.gov>).

July 2013 through September 2014

<u>Volume: Issue</u>	<u>Material Submitted By Noon*</u>	<u>Will Be Published On</u>
29:24	July 10, 2013	July 29, 2013
29:25	July 24, 2013	August 12, 2013
29:26	August 7, 2013	August 26, 2013
30:1	August 21, 2013	September 9, 2013
30:2	September 4, 2013	September 23, 2013
30:3	September 18, 2013	October 7, 2013
30:4	October 2, 2013	October 21, 2013
30:5	October 16, 2013	November 4, 2013
30:6	October 30, 2013	November 18, 2013
30:7	November 13, 2013	December 2, 2013
30:8	November 26, 2013 (Tuesday)	December 16, 2013
30:9	December 11, 2013	December 30, 2013
30:10	December 23, 2013 (Monday)	January 13, 2014
30:11	January 8, 2014	January 27, 2014
30:12	January 22, 2014	February 10, 2014
30:13	February 5, 2014	February 24, 2014
30:14	February 19, 2014	March 10, 2014
30:15	March 5, 2014	March 24, 2014
30:16	March 19, 2014	April 7, 2014
30:17	April 2, 2014	April 21, 2014
30:18	April 16, 2014	May 5, 2014
30:19	April 30, 2014	May 19, 2014
30:20	May 14, 2014	June 2, 2014
30:21	May 28, 2014	June 16, 2014
30:22	June 11, 2014	June 30, 2014
30:23	June 25, 2014	July 14, 2014
30:24	July 9, 2014	July 28, 2014
30:25	July 23, 2014	August 11, 2014
30:26	August 6, 2014	August 25, 2014
30:27	August 20, 2014	September 8, 2014

*Filing deadlines are Wednesdays unless otherwise specified.

PETITIONS FOR RULEMAKING

TITLE 8. EDUCATION

STATE BOARD OF EDUCATION

Agency Decision

Title of Regulation: 8VAC20-390. Rules Governing Division Superintendent of Schools.

Statutory Authority: § 54.1-2400 of the Code of Virginia.

Name of Petitioner: John Butcher.

Nature of Petitioner's Request: 8VAC20-390-80 provides: "It shall be the duty of the division superintendent to visit and inspect each school in his division. He shall inquire into all matters relating to the management of the school, the course of study, method of instruction, and use of textbooks, and shall give particular attention to the conditions of the school buildings." The petitioner requests the Board of Education to render its regulation enforceable by amending 8VAC20-390-80 to append the following paragraph: "The division superintendent shall document each such visit, setting forth the date(s) and time(s) of the required visits and detailing the results of his inquiries. The resulting records shall be kept as public records, subject to inspection under the Freedom of Information Act. The division superintendent shall forward each year's records to the department within thirty days after the close of the fiscal year."

Agency Decision: Request denied.

Statement of Reason for Decision: The Board of Education denies the petitioner's request to amend 8VAC20-390-80 to add the following language: "The division superintendent shall document each such visit, setting forth the date(s) and time(s) of the required visits and detailing the results of his inquiries. The resulting records shall be kept as public records, subject to inspection under the Freedom of Information Act. The division superintendent shall forward each year's records to the Department within thirty days after the close of the fiscal year." Such additional requirements would create a burdensome new recordkeeping mandate on school divisions, when there is no evidence that this new mandate would advance public education.

Agency Contact: Melissa Luchau, Director for Board Relations, Department of Education, 101 North 14th Street, 25th Floor, Richmond, VA 23219, telephone (804) 225-2924, or email melissa.luchau@doe.virginia.gov.

VA.R. Doc. No. R13-20; Filed June 27, 2013, 10:38 a.m.



TITLE 18. PROFESSIONAL AND OCCUPATIONAL LICENSING

BOARD OF DENTISTRY

Initial Agency Notice

Title of Regulation: 18VAC60-20. Regulations Governing Dental Practice.

Statutory Authority: § 54.1-2400 of the Code of Virginia.

Name of Petitioner: Vahid Tavakoli.

Nature of Petitioner's Request: Require all dentists to give a five-year warranty on crowns and bridges to ensure work is durable and thorough.

Agency Plan for Disposition of Request: The petition will be published on July 29, 2013, in the Virginia Register of Regulations and also posted on the Virginia Regulatory Townhall at www.townhall.virginia.gov to receive public comment ending August 28, 2013. The request to amend regulations and any comments for or against the petition will be considered by the board at its meeting scheduled for September 13, 2013.

Public Comment Deadline: August 28, 2013.

Agency Contact: Elaine J. Yeatts, Agency Regulatory Coordinator, Department of Health Professions, 9960 Mayland Drive, Suite 300, Richmond, VA 23233, telephone (804) 367-4688, or email elaine.yeatts@dhp.virginia.gov.

VA.R. Doc. No. R13-30; Filed July 10, 2013, 8:43 a.m.

Initial Agency Notice

Title of Regulation: 18VAC60-20. Regulations Governing Dental Practice.

Statutory Authority: § 54.1-2400 of the Code of Virginia.

Name of Petitioner: Deborah Hickman.

Nature of Petitioner's Request: To amend regulations pertaining to requirements for dental assistants II to add another pathway for registration.

Agency Plan for Disposition of Request: The petition will be published on July 29, 2013, in the Virginia Register of Regulations and also posted on the Virginia Regulatory Townhall at www.townhall.virginia.gov to receive public comment ending August 28, 2013. The request to amend regulations and any comments for or against the petition will be considered by the board at its meeting scheduled for September 13, 2013.

Public Comment Deadline: August 28, 2013.

Agency Contact: Elaine J. Yeatts, Agency Regulatory Coordinator, Department of Health Professions, 9960

Petitions for Rulemaking

Mayland Drive, Suite 300, Richmond, VA 23233, telephone (804) 367-4688, or email elaine.yeatts@dhp.virginia.gov.

VA.R. Doc. No. R13-31; Filed July 10, 2013, 8:49 a.m.

Initial Agency Notice

Title of Regulation: 18VAC60-20. Regulations Governing Dental Practice.

Statutory Authority: § 54.1-2400 of the Code of Virginia.

Name of Petitioner: Terry Dickinson, DDS

Nature of Petitioner's Request: To amend regulations for unprofessional conduct to specify that a dentist cannot: (i) offer rebates or split fees or commissions for services rendered to a patient with any person other than a partner, employee, or employer; nor (ii) directly or indirectly receive a fee or other consideration to or from a third party for the referral of a patient or client.

Agency Plan for Disposition of Request: The petition will be published on July 29, 2013, in the Virginia Register of Regulations and also posted on the Virginia Regulatory Townhall at www.townhall.virginia.gov to receive public comment ending August 28, 2013. The request to amend regulations and any comments for or against the petition will be considered by the board at its meeting scheduled for September 13, 2013.

Public Comment Deadline: August 28, 2013.

Agency Contact: Elaine J. Yeatts, Agency Regulatory Coordinator, Department of Health Professions, 9960 Mayland Drive, Suite 300, Richmond, VA 23233, telephone (804) 367-4688, or email elaine.yeatts@dhp.virginia.gov.

VA.R. Doc. No. R13-32; Filed July 10, 2013, 9:02 a.m.

BOARD OF MEDICINE

Initial Agency Notice

Title of Regulation: 18VAC85-20. Regulations Governing the Practice of Medicine, Osteopathy, Podiatry, and Chiropractic.

Statutory Authority: § 54.1-2400 of the Code of Virginia.

Name of Petitioner: Melody Cartwright.

Nature of Petitioner's Request: To amend requirements for practice by chiropractors relating to treatment and diagnosis of curvature of the spine and the use of digital x-rays.

Agency Plan for Disposition of Request: The petition will be published on July 29, 2013, in the Virginia Register of Regulations and also posted on the Virginia Regulatory Townhall at www.townhall.virginia.gov to receive public comment ending August 28, 2013. Following receipt of all comments on the petition to amend regulations, the board will decide whether to make any changes to the regulatory

language. This matter will be on the board's agenda for its meeting on October 24, 2013.

Public Comment Deadline: August 28, 2013.

Agency Contact: Elaine J. Yeatts, Agency Regulatory Coordinator, Department of Health Professions, 9960 Mayland Drive, Suite 300, Richmond, VA 23233, telephone (804) 367-4688, or email elaine.yeatts@dhp.virginia.gov.

VA.R. Doc. No. R13-33; Filed July 10, 2013, 9:34 a.m.

NOTICES OF INTENDED REGULATORY ACTION

TITLE 18. PROFESSIONAL AND OCCUPATIONAL LICENSING

BOARD OF NURSING

Notice of Intended Regulatory Action

Notice is hereby given in accordance with § 2.2-4007.01 of the Code of Virginia that the Board of Nursing intends to consider amending **18VAC90-20, Regulations Governing the Practice of Nursing**. The purpose of the proposed action is to implement the provisions of Chapter 712 of the 2011 Acts of Assembly. Chapter 712 authorizes the Board of Nursing to revise its regulations to provide for provisional licensure for applicants as registered nurses to obtain supervised clinical experience if their educational programs lacked the requisite number of hours.

The agency intends to hold a public hearing on the proposed action after publication in the Virginia Register.

Statutory Authority: § 54.1-2400 of the Code of Virginia.

Public Comment Deadline: August 28, 2013.

Agency Contact: Jay P. Douglas, R.N., Executive Director, Board of Nursing, 9960 Mayland Drive, Suite 300, Richmond, VA 23233-1463, telephone (804) 367-4515, FAX (804) 527-4455, or email jay.douglas@dhp.virginia.gov.

VA.R. Doc. No. R13-2989; Filed July 9, 2013, 11:17 a.m.

REGULATIONS

For information concerning the different types of regulations, see the Information Page.

Symbol Key

Roman type indicates existing text of regulations. Underscored language indicates proposed new text. Language that has been stricken indicates proposed text for deletion. Brackets are used in final regulations to indicate changes from the proposed regulation.

TITLE 1. ADMINISTRATION

STATE BOARD OF ELECTIONS

Final Regulation

REGISTRAR'S NOTICE: The State Board of Elections is claiming an exemption from the Administrative Process Act pursuant to § 2.2-4002 B 8 of the Code of Virginia, which exempts agency action relating to the conduct of elections or eligibility to vote.

Titles of Regulations: 1VAC20-50. Candidate Qualification (amending 1VAC20-50-20).

1VAC20-60. Election Administration (amending 1VAC20-60-20).

Statutory Authority: §§ 24.2-103 and 24.2-506 of the Code of Virginia.

Effective Date: July 12, 2013.

Agency Contact: Myron McClees, Policy Analyst, State Board of Elections, 1100 Bank Street, Richmond, VA 23219, telephone (804) 864-8949, FAX (804) 786-0760, or email myron.mcclees@sbe.virginia.gov.

Summary:

Pursuant to Chapter 684 of the 2013 Acts of Assembly, the amendments establish standards and procedures for determining the validity of petition signatures.

1VAC20-50-20. Material omissions from candidate petitions and petition signature qualifications.

A. Pursuant to the requirements of §§ 24.2-506, 24.2-521, and 24.2-543 of the Code of Virginia, a petition or a petition signature should not be rendered invalid if it contains an error or omission not material to its proper processing.

B. The following omissions are always material and any petition containing such omissions ~~should~~ shall be rendered invalid if:

1. The petition submitted is not the double-sided document, or a [double-sided] copy thereof, provided by the State Board of Elections;
2. The petition does not have the name, or some variation of the name, and address of the candidate on the front of the form;
3. The petition fails to identify the office sought on the front of the form;
4. The petition fails to identify the applicable election district in which the candidate is running for office;

5. The circulator has not signed the petition affidavit and provided his current address;

6. The circulator is [~~(i) not a legal resident of the Commonwealth,~~ (ii)] a minor [;] or [~~(iii)~~] a felon whose voting rights have not been restored;

7. The circulator has not signed the petition he circulated in the presence of a notary;

8. The circulator has not had a notary sign the affidavit for each petition submitted;

9. [A person other than the circulator signed the petition affidavit;

10.] The notary has not affixed a photographically reproducible seal;

[~~11.~~ 11.] The notary has not included his registration number and commission expiration date; or

[~~12.~~ 12.] Any combination of the scenarios of this subsection exists.

C. ~~If the circulator signs the petition in the "Signature of Registered Voter," his signature shall be invalidated but the petition shall be valid notwithstanding any other error or omission.~~ The following omissions related to individual petition signatures are always material and any petition signature containing such omission shall be rendered invalid if:

1. The signer is not qualified to cast a ballot for the office for which the petition was circulated;

2. The signer is also the circulator of the petition;

3. The signer provided an accompanying date that is subsequent to the date upon which the notary signed the petition;

4. [~~The signer did not sign the petition;~~ or

5.] ~~The signer provided an address that does not match the petition signer's address in the Virginia voter registration system [; or, unless the signer provided an address that is within the same precinct where a voter is currently registered in the Virginia voter registration system, and the signer can be reasonably identified as the same registered voter.]~~

[~~5. The signer did not sign the petition.]~~

D. The following omissions shall be treated as nonmaterial provided ~~that~~ the general registrar can independently and reasonably verify the [~~omitted information~~ validity of the petition or signature] ~~can be independently verified:~~

1. An older version of the petition is used (provided that the information presented complies with current laws, regulations, and guidelines);
2. The "election information" including (i) county, city, or town in which the election will be held; (ii) election type; and (iii) date of election are omitted;
3. The name of the candidate and office sought are omitted from the back of the petition; ~~or~~
4. The circulator has not provided the last four digits of his social security number in the affidavit;
5. The signer omits his first name, provided he provides a combination of his first or middle initials or a middle name and last name and address that matches a qualified voter within the Virginia voter registration system;
6. [The signer provided a derivative of his legal name as his first or middle name (e.g., "Bob" instead of "Robert");
7.] The signer prints his name on the "Print" line and prints his name on the "Sign" line; or
~~[7. 8.] The signer fails to provide the date but a period of time that qualifies can affirmatively be established with previous and subsequent dates provided by other signers upon the petition page.~~

E. A signature upon a petition shall be included in the count toward meeting the petition signature requirements only if:

1. The petition signer is a qualified voter who is maintained on the Virginia voter registration system either (i) with active status or (ii) with inactive status and qualified to vote for the office for which the petition was circulated [~~All qualified voters with inactive status must provide an address upon the petition that matches what is listed for the voter within the Virginia voter registration system~~];
2. The signer provides his name; and
3. The signer provides [~~his house number, street name, street type, and as applicable, city~~ an address] that matches [~~a qualified voter within the petition signer's address in~~] the Virginia voter registration system [~~For purposes of this section, "city" may include the signer's locality, town, or any acceptable mailing name for the five digit zip code of the signer's residence, or the signer provided an address that is within the same precinct where a voter is currently registered in the Virginia voter registration system, and the signer can be reasonably identified as the same registered voter~~].

1VAC20-60-20. Material omissions on referendum petitions and petition signature qualifications.

A. Pursuant to the requirements of § 24.2-684.1 of the Code of Virginia, a petition or a petition signature should not be rendered invalid if it contains an error or omission not material to its proper processing.

B. The following omissions are always material and any petition containing such omissions ~~should~~ shall be rendered invalid if:

1. The petition submitted is not the double-sided document, or a [double-sided] copy thereof, provided by the State Board of Elections;
2. The "question" or "referendum issue" is not stated in a manner set forth by law on the front of the petition;
3. The circulator has not signed the petition affidavit and provided his current address;
4. The circulator is [~~(i) not a legal resident of the Commonwealth, (ii)~~] a minor [;] or [~~(iii)~~] a felon whose [voting] rights have not been restored;
5. The circulator has not signed the affidavit for the petition he circulated in the presence of a notary;
6. The circulator has not had a notary sign the affidavit for each petition submitted;
7. [A person other than the circulator signed the petition affidavit;
8.] The notary has not affixed a photographically reproducible seal;
9. 2.] The notary has not included his registration number and commission expiration date; or
10.] Any combination of the aforementioned scenarios exist.

C. ~~If the circulator signs the petition in the "Signature of Registered Voter" field, his signature shall be invalidated but the petition shall be valid notwithstanding any other error or omission. The following omissions related to individual petition signatures are always material and any petition signature containing such omission shall be rendered invalid if:~~

1. The signer is not qualified to cast a ballot for the referendum for which the petition was circulated;
2. The signer is also the circulator of the petition;
3. The signer provided an accompanying date that is subsequent to the date upon which the notary signed the petition;
4. [The signer did not sign the petition; or
5.] The signer provided an address that does not match the petition signer's address in the Virginia voter registration system [~~or, unless the signer provided an address that is within the same precinct where a voter is currently registered in the Virginia voter registration system, and the signer can be reasonably identified as the same registered voter.~~]
~~[5. The signer did not sign the petition.]~~

D. ~~Subdivision B 3 of this section does not apply to a school board referendum submitted pursuant to § 24.2-57.2 or 24.2-165 of the Code of Virginia.~~

Regulations

~~E. D. The following omissions shall be treated as nonmaterial provided that the general registrar can independently and reasonably verify the [omitted information validity of the petition or signature] can be independently verified:~~

- ~~1. An older version of the petition is used (provided that the information presented complies with current laws, regulations, and guidelines);~~
- ~~2. The "election information" including: (i) county, city, or town in which the election will be held; (ii) election type; and (iii) date of election are omitted; ~~or~~~~
- ~~3. The circulator has not provided the last four digits of his social security number in the affidavit;~~
- ~~4. The signer omits his first name, provided he provides a combination of his first or middle initials or a middle name and last name and address that matches a qualified voter within the Virginia voter registration system;~~
- ~~5. [The signer provided a derivative of his legal name as his first or middle name (e.g., "Bob" instead of "Robert");~~
- ~~6.] The signer prints his name on the "Print" line and prints his name on the "Sign" line; or~~
- ~~[6. 7.] The signer fails to provide the date but a period of time that qualifies can affirmatively be established with previous and subsequent dates provided by other signers upon the petition page.~~

~~E. A signature upon a petition shall be included in the count toward meeting the petition signature requirements only if:~~

- ~~1. The petition signer is a qualified voter who is maintained on the Virginia voter registration system either (i) with active status or (ii) with inactive status and qualified to vote for the office for which the petition was circulated [~~All qualified voters with inactive status must provide an address upon the petition that matches what is listed for the voter within the Virginia voter registration system~~];~~
- ~~2. The signer provides his name; and~~
- ~~3. The signer provides [~~his house number, street name, street type, and as applicable, city~~ an address] that matches [~~a qualified voter within the petition signer's address in~~ the Virginia voter registration system [~~For purposes of this section, "city" may include the signer's locality, town, or any acceptable mailing name for the five digit zip code of the signer's residence, or the signer provided an address that is within the same precinct where a voter is currently registered in the Virginia voter registration system, and the signer can be reasonably identified as the same registered voter~~].~~

VA.R. Doc. No. R13-3744; Filed July 11, 2013, 4:28 p.m.

TITLE 2. AGRICULTURE

BOARD OF AGRICULTURE AND CONSUMER SERVICES

Fast-Track Regulation

Title of Regulation: **2VAC5-685. Regulations Governing Pesticide Applicator Certification under Authority of Virginia Pesticide Control Act (amending 2VAC5-685-70).**

Statutory Authority: § 3.2-3906 of the Code of Virginia.

Public Hearing Information: No public hearings are scheduled.

Public Comment Deadline: August 28, 2013.

Effective Date: September 12, 2013.

Agency Contact: Erin Williams, Policy and Planning Coordinator, Department of Agriculture and Consumer Services, P.O. Box 1163, Richmond, VA 23218, telephone (804) 786-6559 ext: 1308, FAX (804) 371-7479, TTY (800) 828-1120, or email erin.williams@vdacs.virginia.gov.

Basis: Section 3.2-109 of the Code of Virginia authorizes the Board of Agriculture and Consumer Services to adopt regulations in accordance with Title 3.2 of the Code of Virginia regarding agriculture, animal care, and food. Subdivision 4 of § 3.2-3906 of the Code of Virginia authorizes the board to adopt regulations to establish training, testing, and standards for certification of commercial pesticide applicators.

Purpose: The Department of Agriculture and Consumer Services (VDACS) oversees the testing of individuals who desire to become commercial pesticide applicators. 2VAC5-685, Regulations Governing Pesticide Applicator Certification Under Authority of Virginia Pesticide Control Act, establishes the categories and subcategories in which a commercial pesticide applicator may be certified. Certification in the fumigation of soil and agricultural products subcategory and the chemigation subcategory currently requires concurrent certification in the agricultural plant pest control category. This requirement was necessary when each of these subcategories did not have its own separate manual and exam. Now that a manual and exam for both the fumigation of soil and agricultural products subcategory and the chemigation subcategory have been developed, concurrent certification in the agricultural plant pest control category is no longer necessary. This regulation assists in ensuring that commercial pesticide applicators have the necessary knowledge to enable them to properly use pesticides. The proper use of pesticides is essential to protect the health, safety, and welfare of citizens.

Rationale for Using Fast-Track Process: This rulemaking will remove an unnecessary regulatory requirement for concurrent certification for two subcategories of commercial pesticide applicators. Representatives from pesticide trade groups, growers, and pesticide educators commented favorably on

this proposal. Consequently, as this regulatory action will eliminate an unnecessary requirement, the department expects this action to be noncontroversial. Both of these subcategories each have a separate exam. As such, individuals conducting fumigation of soil and agricultural products or chemigation will continue to be tested and certified.

Substance: This regulatory action will remove from 2VAC5-685-70 the requirement of concurrent certification in the agricultural plant pest control category for the subcategories of (i) fumigation of soil and agricultural products and (ii) chemigation.

Issues: The primary advantage of this action for businesses and the agency is the elimination of an unnecessary regulatory requirement for concurrent certification for two subcategories of commercial pesticide applicators. This regulation action poses no disadvantage to the public or the Commonwealth.

Department of Planning and Budget's Economic Impact Analysis:

Summary of the Proposed Amendments to Regulation. The Board of Agriculture and Consumer Services (Board) proposes to remove from Section 70 of 2VAC5-685, Regulations Governing Pesticide Applicator Certification Under Authority of Virginia Pesticide Control Act, the requirement of concurrent certification in the agricultural plant pest control category for the subcategories of (1) fumigation of soil and agricultural products, and (2) chemigation.

Result of Analysis. The benefits likely exceed the costs for all proposed changes.

Estimated Economic Impact. The Department of Agriculture and Consumer Services (Department) oversees the testing of individuals who desire to become commercial pesticide applicators. The Regulations Governing Pesticide Applicator Certification Under Authority of Virginia Pesticide Control Act establish the categories and subcategories in which a commercial pesticide applicator may be certified. Certification in two subcategories, (1) fumigation of soil and agricultural products and (2) chemigation, currently requires concurrent certification in the agricultural plant pest control category. This requirement was necessary when each of these subcategories did not have its own separate manual and exam. Now that a manual and exam for both the fumigation of soil and agricultural products subcategory and the chemigation subcategory have been developed, concurrent certification in the agricultural plant pest control category is no longer necessary.

Therefore, the Board proposes to no longer require concurrent certification in the agricultural plant pest control category for certification in the aforementioned two subcategories. The proposed change will potentially save both time and fees for individuals desiring certification in fumigation or chemigation, but not agricultural plant pest control. The applicants will no longer have to spend the time necessary for

studying and taking the agricultural plant pest control exam, nor wait for the Department to process the application. The Department estimates that the proposed repeal of the concurrent certification will save applicants anywhere from two to four weeks from the removal of studying, exam taking, and application processing associated with the agricultural plant pest control certification. To become a commercial applicator, an individual must first pass a core examination that deals with general principles of pesticide safety and knowledge of appropriate federal and state laws and regulations, and then demonstrate competency in a particular type of pest control by passing the appropriate category examination(s). The certification fee allows applicators to take not only the core exam but also exams in as many other categories as they wish to during a given testing session. If an applicant wishes to certify in an additional category later on, he/she would pay a separate fee. By removing the requirement for concurrent certification, applicators would have fewer exams to take, thus making it more likely that they would complete those exams during one testing session, thereby reducing the fees they pay. The certification fee for the first testing session is \$70. The fee per additional testing session, if needed, is \$35.

Businesses and Entities Affected. Currently, 74 applicators are certified in the fumigation subcategory and 35 applicators are certified in the chemigation subcategory. Approximately 32 businesses will be affected by this regulatory action.¹ The Department estimates that all of the 32 firms are small businesses.

Localities Particularly Affected. The proposed repeal of these regulations does not particularly affect specific localities.

Projected Impact on Employment. The proposed repeal of the concurrent certification in agricultural plant pest control requirement will significantly reduce the time necessary to become certified in fumigation or chemigation. This may increase the supply of available workers, particularly for temporary jobs. This may in practice result in a small increase in the total number of individuals employed in fumigation or chemigation.

Effects on the Use and Value of Private Property. The proposed repeal of the concurrent certification in agricultural plant pest control requirement will save time and in some cases fees for individuals desiring certification in fumigation or chemigation,

Small Businesses: Costs and Other Effects. The proposed repeal of the concurrent certification in agricultural plant pest control requirement will save time and in some cases fees for employees of small firms that provide fumigation or chemigation services.

Small Businesses: Alternative Method that Minimizes Adverse Impact. The proposed amendments do not adversely affect small businesses.

Regulations

Real Estate Development Costs. The proposed amendments are unlikely to significantly affect real estate development costs.

Legal Mandate. The Department of Planning and Budget (DPB) has analyzed the economic impact of this proposed regulation in accordance with § 2.2-4007.04 of the Administrative Process Act and Executive Order Number 14 (10). Section 2.2-4007.04 requires that such economic impact analyses include, but need not be limited to, a determination of the public benefit, the projected number of businesses or other entities to whom the regulation would apply, the identity of any localities and types of businesses or other entities particularly affected, the projected number of persons and employment positions to be affected, the projected costs to affected businesses or entities to implement or comply with the regulation, and the impact on the use and value of private property. Further, if the proposed regulation has an adverse effect on small businesses, § 2.2-4007.04 requires that such economic impact analyses include (i) an identification and estimate of the number of small businesses subject to the regulation; (ii) the projected reporting, recordkeeping, and other administrative costs required for small businesses to comply with the regulation, including the type of professional skills necessary for preparing required reports and other documents; (iii) a statement of the probable effect of the regulation on affected small businesses; and (iv) a description of any less intrusive or less costly alternative methods of achieving the purpose of the regulation. The analysis presented above represents DPB's best estimate of these economic impacts.

¹ Estimate provided by the Virginia Department of Agriculture and Consumer Services

Agency's Response to Economic Impact Analysis: The agency concurs with the analysis of the Department of Planning and Budget.

Summary:

The amendments remove the requirement that a commercial applicator be concurrently certified in the agricultural plant pest control category for the subcategories of (i) fumigation of soil and agricultural products and (ii) chemigation.

Part III

Categories of Pesticide Applicator Certification

2VAC5-685-70. Categories for commercial applicator certification.

A. Commercial applicators must be certified in one or more of the following commercial applicator categories or subcategories:

1. Agricultural pest control.

a. Agricultural plant pest control. This subcategory is for commercial applicators who will be using or supervising

the use of pesticides in production of agricultural crops, or on grasslands, or noncrop agricultural lands.

b. Agricultural animal pest control. This subcategory is for commercial applicators who will be using or supervising the use of pesticides on agriculturally related animals.

c. Fumigation of soil and agricultural products. This subcategory is for commercial applicators who will be using or supervising the use of pesticides for soil fumigation in production of an agricultural commodity and the application of pesticides for fumigation of agricultural products. ~~Certification in this subcategory requires concurrent certification in the agricultural plant pest control category.~~

d. Chemigation. This subcategory is for commercial applicators who will be using or supervising the use of pesticides through an irrigation system. ~~Certification in this subcategory requires concurrent certification in the agricultural plant pest control category.~~

2. Forest pest control. This category is for commercial applicators who will be using or supervising the use of pesticides in forests, forest nurseries, and seed orchards.

3. Ornamental and turf pest control.

a. Ornamental pest control. This subcategory is for commercial applicators who will be using or supervising the use of pesticides in the maintenance and production of ornamental trees, shrubs, and flowers in and out-of-doors.

b. Turf pest control. This subcategory is for commercial applicators who will be using or supervising the use of pesticides in the production and maintenance of turf, including, but not limited to, turf in golf courses, residential lawns, parks, and cemeteries.

4. Seed treatment (excluding fumigation). This category is for commercial applicators who will be using or supervising the use of pesticides on seeds.

5. Aquatic pest control.

a. Aquatic pest control - general. This subcategory is for commercial applicators who will be using or supervising the use of pesticides in or on standing or running water, for the express purpose of controlling pests. This excludes applicators engaged in public health related activities included in subdivision 8 of this subsection, public health pest control.

b. Marine antifoulant paints. This subcategory is for commercial applicators who will be using or supervising the use of marine antifoulant paints containing tributyltin or other restricted use pesticides.

6. Right-of-way pest control. This category is for commercial applicators who will be using or supervising the use of pesticides in the maintenance of public rights-of-

way and in the maintenance of fence lines, structural perimeters or other similar areas.

7. Industrial, institutional, structural, and health-related pest control.

a. General pest control (excluding fumigation). This subcategory is for commercial applicators who will be using or supervising the use of pesticides to control household type pests, pests that inhabit or infest structures, stored products, and residential food preparation areas, and pests capable of infesting or contaminating foods and foodstuffs at any stage of processing facilities.

b. Wood-destroying pest control (excluding fumigation). This subcategory is for commercial applicators who will be using or supervising the use of pesticides to control organisms that destroy structures made of wood.

c. Fumigation. This subcategory is for commercial applicators who will be using or supervising the use of fumigant-type pesticides.

d. Vertebrate pest control (excluding structural invaders). This subcategory is for commercial applicators who will be using or supervising the use of pesticides to control vertebrate pest animals.

e. Sewer root pest control. This subcategory is for commercial applicators who use pesticides for sewer line root control.

8. Public health pest control. This category is for commercial applicators who will be using or supervising the use of pesticides for the management and control of pests having medical and public health significance.

9. Regulatory pest control. This category is for federal, state, and local governmental employee applicators who will be using or supervising the use of pesticides in the control of regulated pests.

10. Demonstration and research pest control. This category is for commercial applicators who will be demonstrating the proper use and techniques of application of pesticides (including classroom demonstration), or who will be supervising such demonstration. It also includes applicators who will be conducting pesticide research on greenhouse or field plots.

11. Aerial pesticide application. This category is for commercial applicators who will be using or supervising the use of any pesticide applied by fixed- or rotary-wing aircraft.

12. Wood preservation and wood product treatment. This category is for commercial applicators who will be using or supervising the use of pesticides at treating plants and sawmills for preservative treatment of wood and wood products.

13. Miscellaneous. This category is to be used to designate categories or subcategories of commercial applicators

using specific pesticides or uses for which the U.S. EPA may mandate certification in order to allow for the pesticide or use.

B. A commercial applicator certified in one category and seeking initial certification in one or more additional categories shall meet the certification requirements of each of the new categories in which he desires certification.

NOTICE: The following forms used in administering the regulation were filed by the agency. The forms are not being published; however, online users of this issue of the Virginia Register of Regulations may click on the name of a form with a hyperlink to access it. The forms are also available from the agency contact or may be viewed at the Office of the Registrar of Regulations, General Assembly Building, 2nd Floor, Richmond, Virginia 23219.

FORMS (2VAC5-685)

[Commercial Pesticide Applicator Certification Application - A, Form VDACS-07211 \(rev. 07/12\)](#)

~~[Commercial Pesticide Applicator Request for Authorization to Take Pesticide Applicator Examination - B, Form VDACS-07218 \(eff. 1/09\)](#)~~

[Commercial Pesticide Applicator Request for Authorization to Take Pesticide Applicator Examination - B, Form VDACS-07218 \(rev. 5/13\)](#)

[Commercial Pesticide Applicator Certification Exam bubble answer sheet, 2003](#)

[Private Pesticide Applicator Certification Exam bubble answer sheet, 2003](#)

[Private Pesticide Applicator Request for Authorization to Take Pesticide Applicator Examination at Department of Motor Vehicles Customer Service Center \(eff. 1/09\)](#)

~~[Power of Attorney \(not dated\)](#)~~

[Power of Attorney \(rev. 5/09\)](#)

[Proof of Additional Category Specific Training for Registered Technicians \(eff. 3/12\)](#)

[Application for Reciprocal Pesticide Applicator Certificate, Form VDACS-07210 \(eff. 5/09\)](#)

[Pesticide Registered Technician Application Form VDACS-07212 \(eff. 1/09\)](#)

VA.R. Doc. No. R13-3730; Filed July 8, 2013, 3:47 p.m.



Regulations

TITLE 4. CONSERVATION AND NATURAL RESOURCES

DEPARTMENT OF MINES, MINERALS AND ENERGY

Final Regulation

REGISTRAR'S NOTICE: The Department of Mines, Minerals and Energy is claiming an exemption from the Administrative Process Act in accordance with § 2.2-4006 A 4 a of the Code of Virginia, which excludes regulations that are necessary to conform to changes in Virginia statutory law where no agency discretion is involved. The Department of Mines, Minerals and Energy will receive, consider, and respond to petitions from any interested person at any time with respect to reconsideration or revision.

Title of Regulation: **4VAC25-140. Coal Surface Mining Regulations (repealing 4VAC25-140-10 through 4VAC25-140-1090).**

Statutory Authority: § 45.1-161.3 of the Code of Virginia.

Effective Date: August 29, 2013.

Agency Contact: Michael Skiffington, Regulatory Coordinator, Department of Mines, Minerals and Energy, 1100 Bank Street, 8th Floor, Richmond, VA 23219-3402, telephone (804) 692-3212, FAX (804) 692-3237, TTY (800) 828-1120, or email mike.skiffington@dmme.virginia.gov.

Summary:

Chapter 47 of the 2013 Acts of Assembly repealed Chapter 17 (§ 45.1-198 et seq.) of Title 45.1 of the Code of Virginia. That chapter was superseded by the Virginia Coal Surface Mining Control and Reclamation Act of 1979, which is codified at Chapter 19 (§ 45.1-180 et seq.) of Title 45.1. This action repeals the regulations promulgated under Chapter 17 as there are no longer any permits outstanding under that chapter. This action is submitted as part of Governor McDonnell's Regulatory Reform Initiative.

VA.R. Doc. No. R13-3759; Filed July 9, 2013, 2:52 p.m.

TITLE 6. CRIMINAL JUSTICE AND CORRECTIONS

BOARD OF CORRECTIONS

Proposed Regulation

Title of Regulation: **6VAC15-40. Minimum Standards for Jails and Lockups (adding 6VAC15-40-985).**

Statutory Authority: §§ 53.1-5, 53.1-68, and 53.1-131 of the Code of Virginia.

Public Hearing Information: No public hearings are scheduled.

Public Comment Deadline: September 27, 2013.

Agency Contact: Jim Bruce, Agency Regulatory Coordinator, Department of Corrections, P.O. Box 26963, Richmond, VA 23261-6963, telephone (804) 674-3303 ext. 1130, FAX (804) 674-3017, or email james.bruce@vadoc.virginia.gov.

Basis: Section 53.1-5 of the Code of Virginia authorizes the Board of Corrections to make, adopt, and promulgate such rules and regulations as may be necessary to carry out the provisions of Title 53.1 of the Code of Virginia and other laws of the Commonwealth pertaining to local, regional, and community correctional facilities. Section 53.1-68 of the Code of Virginia requires the board to prescribe regulations governing the administration and operation of local correctional facilities.

Purpose: The current regulations do not prescribe any special considerations for restraint of offenders known to be pregnant while under the control of local jails and lockups. The proposed changes will specify the type of restraint devices to be used, how the restraint devices may be applied, the circumstances under which the restraints may be used, and reporting requirements for use of restraints on offenders known to be pregnant. The regulations are intended to protect the health and well-being of pregnant jail inmates and their fetuses.

Substance: The proposed regulations require an inmate known to be pregnant to be restrained in the least restrictive manner appropriate to the inmate's situation and perceived flight and security risk. Handcuffs applied to the front of the inmate are the only restraints to be used for transportation outside the secure perimeter. No restraints are to be used during labor and delivery. Inmates in postpartum recovery and when in a medical facility for treatment unrelated to labor and delivery will be restrained in the least restrictive method necessary. An individualized determination must be made to exceed these restraints, and all use of additional restraints shall be reported. Facility staff is required to annually review policy related to restraint of pregnant inmates.

Issues: There has been a wave of public concern related to restraint of pregnant offenders as evidenced by legislation introduced in the 2011 and 2012 General Assembly sessions and a coalition of various organizations and agencies that support statutes and regulation on this subject.

This regulation offers the advantage of protecting the health and well-being of pregnant jail inmates and their fetuses by standardizing the requirements for restraints for pregnant inmates while imposing minimal additional requirements on jail operations. There are no known disadvantages to the public or agency.

Department of Planning and Budget's Economic Impact Analysis:

Summary of the Proposed Amendments to Regulation. The Board of Corrections proposes to establish in the regulations

procedures pertaining to the use of restraints on pregnant inmates in jails and lockups.

Result of Analysis. No significant costs or benefits are expected from the proposed changes.

Estimated Economic Impact. The proposed changes establish procedures in regulations that address the use of restraints on offenders known to be pregnant during transportation outside the secure perimeter, during labor and delivery, postpartum recovery, and for medical treatment unrelated to labor and delivery. The proposed changes also require staff to annually review policy related to restraining pregnant inmates.

According to the Department of Corrections (DOC), the proposed procedures are already followed in practice based on facility policies. Thus, no significant economic impact is expected from the proposed regulations. Also, DOC plans to incorporate the proposed annual review requirement into its periodic training requirement and does not expect any additional costs for its implementation. While no significant direct economic impact is expected, the proposed language may improve the clarity and accessibility of the rules followed in practice.

Businesses and Entities Affected. The proposed regulations apply to 68 jails and lockups. Less than 150 inmates in jails and lockups are estimated to be pregnant at any given time. The number of staff in jails and lockups is about 9,600, but not all will be required to be trained in the use of restraints.

Localities Particularly Affected. The proposed regulations are not expected to affect any locality more than others.

Projected Impact on Employment. No significant impact on employment is expected.

Effects on the Use and Value of Private Property. No significant effect on the use and value of private property is expected.

Small Businesses: Costs and Other Effects. The proposed changes are not anticipated to create any costs or other effects on small businesses.

Small Businesses: Alternative Method that Minimizes Adverse Impact. No adverse impact on small businesses is expected.

Real Estate Development Costs. No effect on real estate development costs is expected.

Legal Mandate. The Department of Planning and Budget (DPB) has analyzed the economic impact of this proposed regulation in accordance with § 2.2-4007.04 of the Administrative Process Act and Executive Order Number 14 (10). Section 2.2-4007.04 requires that such economic impact analyses include, but need not be limited to, the projected number of businesses or other entities to whom the regulation would apply, the identity of any localities and types of businesses or other entities particularly affected, the projected number of persons and employment positions to be affected, the projected costs to affected businesses or entities to implement or comply with the regulation, and the impact on

the use and value of private property. Further, if the proposed regulation has adverse effect on small businesses, § 2.2-4007.04 requires that such economic impact analyses include (i) an identification and estimate of the number of small businesses subject to the regulation; (ii) the projected reporting, recordkeeping, and other administrative costs required for small businesses to comply with the regulation, including the type of professional skills necessary for preparing required reports and other documents; (iii) a statement of the probable effect of the regulation on affected small businesses; and (iv) a description of any less intrusive or less costly alternative methods of achieving the purpose of the regulation. The analysis presented above represents DPB's best estimate of these economic impacts.

Agency's Response to Economic Impact Analysis: The Department of Corrections concurs with the analysis prepared by the Department of Planning and Budget regarding 6VAC15-40, Minimum Standards for Jails and Lockups.

Summary:

The proposed amendments establish procedures pertaining to the use of restraints on pregnant inmates during transportation outside the secure perimeter, during labor and delivery, during postpartum recovery, and when receiving treatment unrelated to labor and delivery. The regulations (i) include criteria and reporting requirements for use of more restrictive restraints and (ii) require staff to annually review policy related to restraining pregnant inmates.

6VAC15-40-985. Restraint of pregnant offenders.

A. This subsection is intended to apply to the transportation outside the secure perimeter such that inmates known to be pregnant shall be handcuffed only in front, unless an individualized determination is made that the inmate is a flight risk or danger to herself or others, or the totality of the circumstances creates a serious security risk.

1. If an individualized determination has been made, then such inmate will be restrained in the least restrictive method necessary for outside transport. Waist chains/belts shall not be used.

2. If it is deemed more restrictive restraints are needed during transport, security staff shall notify a supervisor as soon as reasonably possible and a use of force report indicating the reason for the use of restraints and type of restraints shall be submitted to a supervisor no later than the conclusion of the shift for review and justification.

B. No restraints will be used during labor and delivery unless an individualized determination has been made that the inmate is a flight risk or danger to herself or others, or the totality of the circumstances creates a serious security risk.

C. This subsection is intended to apply to labor and delivery such that if there is an individualized determination that restraints are needed, the least restrictive alternative will be used in consultation with the medical professional, but

Regulations

restraints shall be immediately removed upon the request of any doctor, nurse, or other health professional treating the inmate if the restraints present a threat to the health or life of the inmate or child. Waist chains/belts shall not be used.

D. If it is deemed more restrictive restraints are needed during labor and delivery, security staff shall notify a supervisor as soon as reasonably practical and a use of force report indicating the reason for the use of restraints and type of restraints shall be submitted to a supervisor no later than the conclusion of the shift for review and justification.

E. This subsection is intended to apply during postpartum recovery while the inmate is in the hospital such that after an individualized determination, an inmate shall be restrained in the least restrictive method (i.e., one ankle restraint or one arm restraint) that will allow for the mother's safe handling of her infant and mother-infant bonding, except where necessary when the inmate is a flight risk or danger to herself or others, or the totality of the circumstances creates a serious security risk. If it is deemed restraints more restrictive than one ankle restraint or one arm restraint are needed, security staff shall notify a supervisor as soon as reasonably practical and a use of force report indicating the reason for the use of restraints and type of restraints shall be submitted to a supervisor no later than the conclusion of the shift for review and justification.

F. All staff shall annually review policy related to restraining pregnant inmates.

G. This subsection is intended to apply to inmates known to be pregnant who are in a facility for medical treatment unrelated to labor and delivery. Such inmates will be restrained in the least restrictive method necessary in consultation with the medical professional. Waist chains/belts shall not be used.

VA.R. Doc. No. R12-3078; Filed July 1, 2013, 1:15 p.m.

TITLE 8. EDUCATION

STATE BOARD OF EDUCATION

Final Regulation

REGISTRAR'S NOTICE: The State Board of Education is claiming an exemption from the Administrative Process Act in accordance with § 2.2-4006 A 4 a of the Code of Virginia, which excludes regulations that are necessary to conform to changes in Virginia statutory law where no agency discretion is involved. The State Board of Education will receive, consider, and respond to petitions from any interested person at any time with respect to reconsideration or revision.

Title of Regulation: 8VAC20-22. Licensure Regulations for School Personnel (amending 8VAC20-22-40, 8VAC20-22-110).

Statutory Authority: § 22.1-298.1 of the Code of Virginia.

Effective Date: August 28, 2013.

Agency Contact: Patty Pitts, Assistant Superintendent for Teacher Education and Licensure, Department of Education, P.O. Box 2120, Richmond, VA 23218, telephone (804) 371-2522, or email patty.pitts@doe.virginia.gov.

Summary:

This regulation is amended to comport with Chapter 726 and identical Chapters 498 and 530 of the 2013 Acts of Assembly. The amendment required by Chapter 726 requires any individual licensed and endorsed to teach (i) middle school civics or economics or (ii) high school government or history who is seeking renewal of such license to demonstrate knowledge of Virginia history or state and local government by completing a module or professional development course specifically related to Virginia history or state and local government that has a value of five professional development points. This requirement applies for purposes of the individual's next or initial renewal occurring after July 1, 2014. The amendment made pursuant to Chapters 498 and 530 requires every person seeking initial licensure or renewal of a license to provide evidence of completion of certification or training in emergency first aid, cardiopulmonary resuscitation, and the use of automated external defibrillators. This requirement is waived for any person with a disability whose disability prohibits the person from completing the certification or training.

8VAC20-22-40. Conditions for licensure.

A. Applicants for licensure must:

1. Be at least 18 years of age;
2. Pay the appropriate fees as determined by the Board of Education and complete the application process;
3. Have earned a baccalaureate degree (with the exception of the Technical Professional License) from a regionally accredited institution of higher education and meet requirements for the license sought. Persons seeking initial licensure who graduate from Virginia institutions of higher education shall only be licensed as instructional personnel by the Board of Education if the endorsement areas offered at such institutions have been assessed by a national accrediting agency or by a state approval process with final approval by the Board of Education; and
4. Possess good moral character (free of conditions outlined in Part VII (8VAC20-22-690 et seq.) of this chapter.

B. All candidates who hold at least a baccalaureate degree from a regionally accredited college or university and who seek an initial Virginia teaching license must obtain passing scores on professional teacher's assessments prescribed by the Board of Education. With the exception of the career switcher program that requires assessments as prerequisites, individuals must complete the professional teacher's

assessments within the three-year validity of the initial provisional license. Candidates seeking a Technical Professional License, the International License, School Manager License, or the Pupil Personnel Services License are not required to take the professional teacher's assessments. Individuals who hold a valid out-of-state license (full credential with no deficiencies) and who have completed a minimum of three years of full-time, successful teaching experience in a public or accredited nonpublic school (kindergarten through grade 12) in a state other than Virginia are exempted from the professional teacher's assessment requirements.

C. All individuals seeking an initial endorsement in early/primary education preK-3, elementary education preK-6, special education-general curriculum, special education-hearing disorders, special education-visual impairments and individuals seeking an endorsement as a reading specialist must obtain passing scores on a reading instructional assessment prescribed by the Board of Education.

D. Licensure by reciprocity is set forth in 8VAC20-22-100. A school leader's assessment prescribed by the Board of Education must be met for all individuals who are seeking an initial endorsement authorizing them to serve as principals and assistant principals in the public schools. Individuals seeking an initial administration and supervision endorsement who are interested in serving as central office instructional personnel are not required to take and pass the school leaders assessment prescribed by the Board of Education.

E. Individuals seeking initial licensure must demonstrate proficiency in the use of educational technology for instruction, complete study in child abuse recognition and intervention in accordance with curriculum guidelines developed by the Board of Education in consultation with the Department of Social Services, and receive professional development in instructional methods tailored to promote student academic progress and effective preparation for the Standards of Learning end-of-course and end-of-grade assessments.

F. Every person seeking initial licensure of a license shall provide evidence of completion of certification or training in emergency first aid, cardiopulmonary resuscitation, and the use of automated external defibrillators. The certification or training program shall be based on the current national evidenced-based emergency cardiovascular care guidelines for cardiopulmonary resuscitation and the use of an automated external defibrillator, such as a program developed by the American Heart Association or the American Red Cross. The Virginia Board of Education shall provide a waiver for this requirement for any person with a disability whose disability prohibits such person from completing the certification or training.

8VAC20-22-110. Requirements for renewing a license.

A. The Division Superintendent, Postgraduate Professional, Collegiate Professional, Technical Professional, Pupil

Personnel Services, and School Manager Licenses may be renewed upon the completion of 180 professional development points within a five-year validity period based on an individualized professional development plan that includes ongoing, sustained, and high-quality professional development.

B. Virginia public school divisions and public education agencies must report annually to the Department of Education that instructional personnel have completed high quality professional development each year as set forth by the Virginia Department of Education.

C. Any individual licensed and endorsed to teach (i) middle school civics or economics or (ii) high school government or history who is seeking renewal of such license is required to demonstrate knowledge of Virginia history or state and local government by completing a module or professional development course specifically related to Virginia history or state and local government that has a value of five professional development points. This requirement applies for purposes of the individual's next or initial renewal occurring after July 1, 2014.

D. Every person seeking renewal of a license shall provide evidence of completion of certification or training in emergency first aid, cardiopulmonary resuscitation, and the use of automated external defibrillators. The certification or training program shall be based on the current national evidenced-based emergency cardiovascular care guidelines for cardiopulmonary resuscitation and the use of an automated external defibrillator, such as a program developed by the American Heart Association or the American Red Cross. The Virginia Board of Education shall provide a waiver for this requirement for any person with a disability whose disability prohibits such person from completing the certification or training.

~~C.~~ E. Professional development points may be accrued by the completion of professional development activities to improve and increase instructional personnel's knowledge of the academic subjects the teachers teach or the area assigned from one or more of the following eight options.

1. College credit. Acceptable coursework offers content that provides new information and is offered on-campus, off-campus, or through extension by any regionally accredited two-year or four-year college or university. College coursework must develop further experiences in subject content taught, teaching strategies, uses of technologies, leadership, and other essential elements in teaching to high standards and increasing student learning. At least 90 points for each five-year renewal shall be in the content area(s) currently being taught if the license holder does not hold a graduate degree. Instructional personnel must complete coursework to improve and increase the knowledge of the academic subjects or endorsement areas in which they are assigned.

Regulations

2. Professional conference. A professional conference is a workshop, institute, or seminar of four or more hours that contributes to ongoing, sustained, and high-quality professional development.

3. Curriculum development. Curriculum development is a group activity in which the license holder contributes to the improvement of the curriculum of a school, a school division, or an education institution in the teaching area assigned. This includes the alignment of curriculum frameworks, instructional materials, and assessments to provide a system with clear expectations of what is to be taught and learned.

4. Publication of article. The article must contribute to the education profession or to the body of knowledge of the license holder's teaching area or instructional position. Grant reports that present the results of educational research are acceptable provided the license holder had an active role in planning, analyzing, interpreting, demonstrating, disseminating, or evaluating the study or innovation. The article must be published in a recognized professional journal.

5. Publication of book. Books must be published for purchase and must contribute to the education profession or to the body of knowledge of the license holder's teaching area or instructional position. The published book must increase the field of content knowledge, planning and assessment for evaluating and providing students with feedback that encourages student progress and measures student achievement, instruction, safety and learning environment, communication and community relations working with students, parents, and members of the community to promote broad support for student learning. Points will not be awarded for books self-published.

6. Mentorship. Mentoring is the process by which an experienced professional, who has received mentorship training, provides assistance to one or more persons for the purpose of improving their performance. Assistance may involve role modeling, direct instruction, demonstration, observation with feedback, developing of plans, and consultation to promote instructional excellence and increased student achievement. Mentoring may include the supervision of a field experience of a preservice student teacher or an intern in an approved teacher/principal preparation program, as well as mentoring as part of the induction process for a beginning teacher or a first-year administrator. Individuals serving in this role and submitting documentation for license renewal based on the mentorship option shall receive training as a mentor prior to the assignment and at least once during the five-year renewal cycle.

7. Educational project. Educational projects must be planned, focused projects based on high standards of teaching and learning. Projects must result in a written report or other tangible product. Projects must contribute to

the education profession or to the body of knowledge of the license holder's teaching area or instructional position. A project could include participation in new professional responsibilities, such as leading a school improvement initiative.

8. Professional development activity. Professional development activities must focus on student learning and achievement, schoolwide educational improvement, leadership, subject content, teaching strategies, and use of technologies and other essential elements in teaching to high standards. Activities must be planned, rigorous, systematic, and promote continuous inquiry and reflection. Local employing educational agencies are encouraged to design professional development activities that are conducted in school settings and linked to student learning and achievement.

~~D. E.~~ F. A minimum of 90 points (three semester hours in a content area) at the undergraduate (two-year or four-year institution) or graduate level in the license holder's endorsement areas shall be required of license holders without a master's degree and may be satisfied at the undergraduate (two-year or four-year institution) or graduate level. Special education coursework designed to assist classroom teachers and other school personnel in working with students with disabilities, a course in gifted education, a course in educational technology, or a course in English as a second language may be completed to satisfy the content course requirement for one cycle of the renewal process. Professional development activities designed to support the Virginia Standards of Learning, Standards of Accreditation, and Assessments may be accepted in lieu of the content course for one renewal cycle. The substance of the activities must clearly support these initiatives and address one or more of the following areas: (i) new content knowledge to implement the Virginia Standards of Learning; (ii) curriculum development initiative designed to translate the standards from standards to classroom objectives; (iii) teaching beginning reading skills including phonemic awareness and the structure of language (phonics); (iv) staff development activities in assessment to assist classroom teachers in the utilization of test results to improve classroom instruction; and (v) professional development designed to implement the technology standards in the schools. Technical Professional License holders without baccalaureate degrees may satisfy the requirement through career and technical education workshops, career and technical education institutes, or through undergraduate coursework at two-year or four-year institutions.

~~E. G.~~ G. Content area courses are courses at the undergraduate level (two-year or four-year institution) or at the graduate level that will not duplicate previous courses taken in the humanities, history and social sciences, the sciences, mathematics, health and physical education, and the fine arts. These courses are usually available through the college or department of arts and sciences. License holders with

elementary education, middle education, special education, or reading endorsements must satisfy the 90-point requirement through reading coursework or content coursework in one of the areas listed above. Courses available through a regionally accredited college's or institution's department of education may be used to satisfy the content requirement for those license holders with endorsements in health and physical education, career and technical education, and library science education.

~~F.~~ H. With prior approval of the division superintendent, the 90 points in a content area also may be satisfied through coursework taken to obtain a new teaching endorsement or coursework taken because of a particular need of a particular teacher.

~~G.~~ I. The remaining 90 points may be accrued by activities drawn from one or more of the eight renewal options. Renewal work is designed to provide licensed personnel with opportunities for professional development relative to the grade levels or teaching fields to which they are assigned or for which they seek an added endorsement. Such professional development encompasses (i) responsible remediation of any area of an individual's knowledge or skills that fail to meet the standards of competency and (ii) responsible efforts to increase the individual's knowledge of new developments in his field and to respond to new curricular demands within the person's area of professional competence.

~~H.~~ J. The proposed work toward renewal in certain options must be approved in advance by the chief executive officer or designee of the employing educational agency. Persons who are not employed by an educational agency may renew or reinstate their license by submitting to the Office of Professional Licensure, Department of Education, their individualized renewal record and verification of points, including official student transcripts of coursework taken at an accredited two-year or four-year college or university.

~~I.~~ K. Accrual of professional development points shall be determined by criteria set forth by the Virginia Department of Education.

~~J.~~ L. Persons seeking license renewal as teachers must demonstrate proficiency in the use of educational technology for instruction.

~~K.~~ M. Virginia school divisions and nonpublic schools will recommend renewal of licenses using the renewal point system. The renewal recommendation must include verification of demonstrated proficiency in the use of educational technology for instruction.

~~L.~~ N. Training in instructional methods tailored to promote academic progress and effective preparation for the Standards of Learning tests and end-of-grade assessments is required for licensure renewal.

~~M.~~ O. If they have not already met the requirement, persons seeking licensure renewal as teachers must complete study in child abuse recognition and intervention in accordance with

curriculum guidelines developed by the Board of Education in consultation with the Department of Social Services that are relevant to the specific teacher licensure routes.

VA.R. Doc. No. R13-3779; Filed June 27, 2013, 11:56 a.m.

◆ ————— ◆
TITLE 9. ENVIRONMENT

STATE AIR POLLUTION CONTROL BOARD

Final Regulation

REGISTRAR'S NOTICE: The State Air Pollution Control Board is claiming an exclusion from the Administrative Process Act in accordance with § 2.2-4006 A 4 a of the Code of Virginia, which excludes regulations that are necessary to conform to changes in Virginia statutory law where no agency discretion is involved. The State Air Pollution Control Board will receive, consider, and respond to petitions by any interested person at any time with respect to reconsideration or revision.

Titles of Regulations: **9VAC5-10. General Definitions (amending 9VAC5-10-20) (Rev. F13).**

9VAC5-170. Regulation for General Administration (amending 9VAC5-170-200) (Rev. F13).

Statutory Authority: § 10.1-1308 of the Code of Virginia.

Effective Date: August 28, 2013.

Agency Contact: Gary E. Graham, Department of Environmental Quality, 629 East Main Street, P.O. Box 1105, Richmond, VA 23218, telephone (804) 698-4103, FAX (804) 698-4510, TTY (804) 698-4021, or email gary.graham@deq.virginia.gov.

Summary:

The amendments allow documents and notifications to be delivered through postal or electronic means as required by Chapter 348 of the 2013 Acts of Assembly, which amended § 10.1-1183 of the Code of Virginia.

9VAC5-10-20. Terms defined.

"Actual emissions rate" means the actual rate of emissions of a pollutant from an emissions unit. In general actual emissions shall equal the average rate, in tons per year, at which the unit actually emitted the pollutant during the most recent two-year period or some other two-year period which is representative of normal source operation. If the board determines that no two-year period is representative of normal source operation, the board shall allow the use of an alternative period of time upon a determination by the board that it is more representative of normal source operation. Actual emissions shall be calculated using the unit's actual operating hours, production rates, and types of materials processed, stored, or combusted during the selected time period.

Regulations

"Administrator" means the administrator of the U.S. Environmental Protection Agency (EPA) or his authorized representative.

"Affected facility" means, with reference to a stationary source, any part, equipment, facility, installation, apparatus, process or operation to which an emission standard is applicable or any other facility so designated. The term "affected facility" includes any affected source as defined in 40 CFR 63.2.

"Air pollution" means the presence in the outdoor atmosphere of one or more substances which are or may be harmful or injurious to human health, welfare or safety; to animal or plant life; or to property; or which unreasonably interfere with the enjoyment by the people of life or property.

"Air quality" means the specific measurement in the ambient air of a particular air pollutant at any given time.

"Air quality control region" means any area designated as such in 9VAC5-20-200.

"Alternative method" means any method of sampling and analyzing for an air pollutant which is not a reference or equivalent method, but which has been demonstrated to the satisfaction of the board, in specific cases, to produce results adequate for its determination of compliance.

"Ambient air" means that portion of the atmosphere, external to buildings, to which the general public has access.

"Ambient air quality standard" means any primary or secondary standard designated as such in 9VAC5-30 (Ambient Air Quality Standards).

"Board" means the State Air Pollution Control Board or its designated representative.

"Certified mail" means electronically certified or postal certified mail, except that this definition shall only apply to the mailing of plan approvals, permits, or certificates issued under the provisions of these regulations and only where the recipient has notified the department of the recipient's consent to receive plan approvals, permits, or certificates by electronic mail. Any provision of these regulations requiring the use of certified mail to transmit special orders or administrative orders pursuant to enforcement proceedings shall mean postal certified mail.

"Class I area" means any prevention of significant deterioration area (i) in which virtually any deterioration of existing air quality is considered significant and (ii) designated as such in 9VAC5-20-205.

"Class II area" means any prevention of significant deterioration area (i) in which any deterioration of existing air quality beyond that normally accompanying well-controlled growth is considered significant and (ii) designated as such in 9VAC5-20-205.

"Class III area" means any prevention of significant deterioration area (i) in which deterioration of existing air

quality to the levels of the ambient air quality standards is permitted and (ii) designated as such in 9VAC5-20-205.

"Continuous monitoring system" means the total equipment used to sample and condition (if applicable), to analyze, and to provide a permanent continuous record of emissions or process parameters.

"Control program" means a plan formulated by the owner of a stationary source to establish pollution abatement goals, including a compliance schedule to achieve such goals. The plan may be submitted voluntarily, or upon request or by order of the board, to ensure compliance by the owner with standards, policies and regulations adopted by the board. The plan shall include system and equipment information and operating performance projections as required by the board for evaluating the probability of achievement. A control program shall contain the following increments of progress:

1. The date by which contracts for emission control system or process modifications are to be awarded, or the date by which orders are to be issued for the purchase of component parts to accomplish emission control or process modification.
2. The date by which the on-site construction or installation of emission control equipment or process change is to be initiated.
3. The date by which the on-site construction or installation of emission control equipment or process modification is to be completed.
4. The date by which final compliance is to be achieved.

"Criteria pollutant" means any pollutant for which an ambient air quality standard is established under 9VAC5-30 (Ambient Air Quality Standards).

"Day" means a 24-hour period beginning at midnight.

"Delayed compliance order" means any order of the board issued after an appropriate hearing to an owner which postpones the date by which a stationary source is required to comply with any requirement contained in the applicable implementation plan.

"Department" means any employee or other representative of the Virginia Department of Environmental Quality, as designated by the director.

"Director" or "executive director" means the director of the Virginia Department of Environmental Quality or a designated representative.

"Dispersion technique"

1. Means any technique which attempts to affect the concentration of a pollutant in the ambient air by:
 - a. Using that portion of a stack which exceeds good engineering practice stack height;
 - b. Varying the rate of emission of a pollutant according to atmospheric conditions or ambient concentrations of that pollutant; or

c. Increasing final exhaust gas plume rise by manipulating source process parameters, exhaust gas parameters, stack parameters, or combining exhaust gases from several existing stacks into one stack; or other selective handling of exhaust gas streams so as to increase the exhaust gas plume rise.

2. The preceding sentence does not include:

a. The reheating of a gas stream, following use of a pollution control system, for the purpose of returning the gas to the temperature at which it was originally discharged from the facility generating the gas stream;

b. The merging of exhaust gas streams where:

(1) The owner demonstrates that the facility was originally designed and constructed with such merged gas streams;

(2) After July 8, 1985, such merging is part of a change in operation at the facility that includes the installation of pollution controls and is accompanied by a net reduction in the allowable emissions of a pollutant. This exclusion from the definition of "dispersion techniques" shall apply only to the emissions limitation for the pollutant affected by such change in operation; or

(3) Before July 8, 1985, such merging was part of a change in operation at the facility that included the installation of emissions control equipment or was carried out for sound economic or engineering reasons. Where there was an increase in the emissions limitation or, in the event that no emissions limitation was in existence prior to the merging, an increase in the quantity of pollutants actually emitted prior to the merging, the board shall presume that merging was significantly motivated by an intent to gain emissions credit for greater dispersion. Absent a demonstration by the owner that merging was not significantly motivated by such intent, the board shall deny credit for the effects of such merging in calculating the allowable emissions for the source;

c. Smoke management in agricultural or silvicultural prescribed burning programs;

d. Episodic restrictions on residential woodburning and open burning; or

e. Techniques under subdivision 1 c of this definition which increase final exhaust gas plume rise where the resulting allowable emissions of sulfur dioxide from the facility do not exceed 5,000 tons per year.

"Emergency" means a situation that immediately and unreasonably affects, or has the potential to immediately and unreasonably affect, public health, safety or welfare; the health of animal or plant life; or property, whether used for recreational, commercial, industrial, agricultural or other reasonable use.

"Emissions limitation" means any requirement established by the board which limits the quantity, rate, or concentration

of continuous emissions of air pollutants, including any requirements which limit the level of opacity, prescribe equipment, set fuel specifications, or prescribe operation or maintenance procedures to assure continuous emission reduction.

"Emission standard" means any provision of 9VAC5-40 (Existing Stationary Sources), 9VAC5-50 (New and Modified Stationary Sources), or 9VAC5-60 (Hazardous Air Pollutant Sources) that prescribes an emissions limitation, or other requirements that control air pollution emissions.

"Emissions unit" means any part of a stationary source which emits or would have the potential to emit any air pollutant.

"Equivalent method" means any method of sampling and analyzing for an air pollutant which has been demonstrated to the satisfaction of the board to have a consistent and quantitative relationship to the reference method under specified conditions.

"EPA" means the U.S. Environmental Protection Agency or an authorized representative.

"Excess emissions" means emissions of air pollutant in excess of an emission standard.

"Excessive concentration" is defined for the purpose of determining good engineering practice (GEP) stack height under subdivision 3 of the GEP definition and means:

1. For sources seeking credit for stack height exceeding that established under subdivision 2 of the GEP definition, a maximum ground-level concentration due to emissions from a stack due in whole or part to downwash, wakes, and eddy effects produced by nearby structures or nearby terrain features which individually is at least 40% in excess of the maximum concentration experienced in the absence of such downwash, wakes, or eddy effects and which contributes to a total concentration due to emissions from all sources that is greater than an ambient air quality standard. For sources subject to the provisions of Article 8 (9VAC5-80-1605 et seq.) of Part II of 9VAC5-80 (Permits for Stationary Sources), an excessive concentration alternatively means a maximum ground-level concentration due to emissions from a stack due in whole or part to downwash, wakes, or eddy effects produced by nearby structures or nearby terrain features which individually is at least 40% in excess of the maximum concentration experienced in the absence of such downwash, wakes, or eddy effects and greater than a prevention of significant deterioration increment. The allowable emission rate to be used in making demonstrations under this provision shall be prescribed by the new source performance standard that is applicable to the source category unless the owner demonstrates that this emission rate is infeasible. Where such demonstrations are approved by the board, an alternative emission rate shall be established in consultation with the owner;

Regulations

2. For sources seeking credit after October 11, 1983, for increases in existing stack heights up to the heights established under subdivision 2 of the GEP definition, either (i) a maximum ground-level concentration due in whole or part to downwash, wakes or eddy effects as provided in subdivision 1 of this definition, except that the emission rate specified by any applicable implementation plan (or, in the absence of such a limit, the actual emission rate) shall be used, or (ii) the actual presence of a local nuisance caused by the existing stack, as determined by the board; and

3. For sources seeking credit after January 12, 1979, for a stack height determined under subdivision 2 of the GEP definition where the board requires the use of a field study or fluid model to verify GEP stack height, for sources seeking stack height credit after November 9, 1984, based on the aerodynamic influence of cooling towers, and for sources seeking stack height credit after December 31, 1970, based on the aerodynamic influence of structures not adequately represented by the equations in subdivision 2 of the GEP definition, a maximum ground-level concentration due in whole or part to downwash, wakes or eddy effects that is at least 40% in excess of the maximum concentration experienced in the absence of such downwash, wakes, or eddy effects.

"Existing source" means any stationary source other than a new source or modified source.

"Facility" means something that is built, installed or established to serve a particular purpose; includes, but is not limited to, buildings, installations, public works, businesses, commercial and industrial plants, shops and stores, heating and power plants, apparatus, processes, operations, structures, and equipment of all types.

"Federal Clean Air Act" means Chapter 85 (§ 7401 et seq.) of Title 42 of the United States Code.

"Federally enforceable" means all limitations and conditions which are enforceable by the administrator and citizens under the federal Clean Air Act or that are enforceable under other statutes administered by the administrator. Federally enforceable limitations and conditions include, but are not limited to, the following:

1. Emission standards, alternative emission standards, alternative emissions limitations, and equivalent emissions limitations established pursuant to § 112 of the federal Clean Air Act as amended in 1990.

2. New source performance standards established pursuant to § 111 of the federal Clean Air Act, and emission standards established pursuant to § 112 of the federal Clean Air Act before it was amended in 1990.

3. All terms and conditions in a federal operating permit, including any provisions that limit a source's potential to emit, unless expressly designated as not federally enforceable.

4. Limitations and conditions that are part of an implementation plan.

5. Limitations and conditions that are part of a section 111(d) or section 111(d)/129 plan.

6. Limitations and conditions that are part of a federal construction permit issued under 40 CFR 52.21 or any construction permit issued under regulations approved by EPA in accordance with 40 CFR Part 51.

7. Limitations and conditions that are part of an operating permit issued pursuant to a program approved by EPA into an implementation plan as meeting EPA's minimum criteria for federal enforceability, including adequate notice and opportunity for EPA and public comment prior to issuance of the final permit and practicable enforceability.

8. Limitations and conditions in a Virginia regulation or program that has been approved by EPA under subpart E of 40 CFR Part 63 for the purposes of implementing and enforcing § 112 of the federal Clean Air Act.

9. Individual consent agreements issued pursuant to the legal authority of EPA.

"Good engineering practice" or "GEP," with reference to the height of the stack, means the greater of:

1. 65 meters, measured from the ground-level elevation at the base of the stack;

2. a. For stacks in existence on January 12, 1979, and for which the owner had obtained all applicable permits or approvals required under 9VAC5-80 (Permits for Stationary Sources),

$$Hg = 2.5H,$$

provided the owner produces evidence that this equation was actually relied on in establishing an emissions limitation;

b. For all other stacks,

$$Hg = H + 1.5L,$$

where:

Hg = good engineering practice stack height, measured from the ground-level elevation at the base of the stack,

H = height of nearby structure(s) measured from the ground-level elevation at the base of the stack,

L = lesser dimension, height or projected width, of nearby structure(s) provided that the board may require the use of a field study or fluid model to verify GEP stack height for the source; or

3. The height demonstrated by a fluid model or a field study approved by the board, which ensures that the emissions from a stack do not result in excessive concentrations of any air pollutant as a result of atmospheric downwash, wakes, or eddy effects created by the source itself, nearby structures or nearby terrain features.

"Hazardous air pollutant" means an air pollutant to which no ambient air quality standard is applicable and which in the judgment of the administrator causes, or contributes to, air pollution which may reasonably be anticipated to result in an increase in mortality or an increase in serious irreversible, or incapacitating reversible, illness.

"Implementation plan" means the portion or portions of the state implementation plan, or the most recent revision thereof, which has been approved under § 110 of the federal Clean Air Act, or promulgated under § 110(c) of the federal Clean Air Act, or promulgated or approved pursuant to regulations promulgated under § 301(d) of the federal Clean Air Act and which implements the relevant requirements of the federal Clean Air Act.

"Initial emission test" means the test required by any regulation, permit issued pursuant to 9VAC5-80 (Permits for Stationary Sources), control program, compliance schedule or other enforceable mechanism for determining compliance with new or more stringent emission standards or permit limitations or other emissions limitations requiring the installation or modification of air pollution control equipment or implementation of a control method. Initial emission tests shall be conducted in accordance with 9VAC5-40-30.

"Initial performance test" means the test required by (i) 40 CFR Part 60 for determining compliance with standards of performance, or (ii) a permit issued pursuant to 9VAC5-80 (Permits for Stationary Sources) for determining initial compliance with permit limitations. Initial performance tests shall be conducted in accordance with 9VAC5-50-30 and 9VAC5-60-30.

"Isokinetic sampling" means sampling in which the linear velocity of the gas entering the sampling nozzle is equal to that of the undisturbed gas stream at the sample point.

"Locality" means a city, town, county or other public body created by or pursuant to state law.

"Mail" means electronic or postal delivery.

"Maintenance area" means any geographic region of the United States previously designated as a nonattainment area and subsequently redesignated to attainment subject to the requirement to develop a maintenance plan and designated as such in 9VAC5-20-203.

"Malfunction" means any sudden failure of air pollution control equipment, of process equipment, or of a process to operate in a normal or usual manner, which failure is not due to intentional misconduct or negligent conduct on the part of the owner or other person. Failures that are caused in part by poor maintenance or careless operation are not malfunctions.

"Monitoring device" means the total equipment used to measure and record (if applicable) process parameters.

"Nearby" as used in the definition of good engineering practice (GEP) is defined for a specific structure or terrain feature and:

1. For purposes of applying the formulae provided in subdivision 2 of the GEP definition means that distance up to five times the lesser of the height or the width dimension of a structure, but not greater than 0.8 km (1/2 mile); and

2. For conducting demonstrations under subdivision 3 of the GEP definition means not greater than 0.8 km (1/2 mile), except that the portion of a terrain feature may be considered to be nearby which falls within a distance of up to 10 times the maximum height (Ht) of the feature, not to exceed two miles if such feature achieves a height (Ht) 0.8 km from the stack that is at least 40% of the GEP stack height determined by the formulae provided in subdivision 2 b of the GEP definition or 26 meters, whichever is greater, as measured from the ground-level elevation at the base of the stack. The height of the structure or terrain feature is measured from the ground-level elevation at the base of the stack.

"Nitrogen oxides" means all oxides of nitrogen except nitrous oxide, as measured by test methods set forth in 40 CFR Part 60.

"Nonattainment area" means any area which is shown by air quality monitoring data or, where such data are not available, which is calculated by air quality modeling (or other methods determined by the board to be reliable) to exceed the levels allowed by the ambient air quality standard for a given pollutant including, but not limited to, areas designated as such in 9VAC5-20-204.

"One hour" means any period of 60 consecutive minutes.

"One-hour period" means any period of 60 consecutive minutes commencing on the hour.

"Organic compound" means any chemical compound of carbon excluding carbon monoxide, carbon dioxide, carbonic disulfide, carbonic acid, metallic carbides, metallic carbonates and ammonium carbonate.

"Owner" means any person, including bodies politic and corporate, associations, partnerships, personal representatives, trustees and committees, as well as individuals, who owns, leases, operates, controls or supervises a source.

"Particulate matter" means any airborne finely divided solid or liquid material with an aerodynamic diameter smaller than 100 micrometers.

"Particulate matter emissions" means all finely divided solid or liquid material, other than uncombined water, emitted to the ambient air as measured by the applicable reference method, or an equivalent or alternative method.

"PM₁₀" means particulate matter with an aerodynamic diameter less than or equal to a nominal 10 micrometers as measured by the applicable reference method or an equivalent method.

"PM₁₀ emissions" means finely divided solid or liquid material, with an aerodynamic diameter less than or equal to a nominal 10 micrometers emitted to the ambient air as

Regulations

measured by the applicable reference method, or an equivalent or alternative method.

"Performance test" means a test for determining emissions from new or modified sources.

"Person" means an individual, corporation, partnership, association, a governmental body, a municipal corporation, or any other legal entity.

"Pollutant" means any substance the presence of which in the outdoor atmosphere is or may be harmful or injurious to human health, welfare or safety, to animal or plant life, or to property, or which unreasonably interferes with the enjoyment by the people of life or property.

"Potential to emit" means the maximum capacity of a stationary source to emit a pollutant under its physical and operational design. Any physical or operational limitation on the capacity of the source to emit a pollutant, including air pollution control equipment, and restrictions on hours of operation or on the type or amount of material combusted, stored, or processed, shall be treated as part of its design only if the limitation or its effect on emissions is state and federally enforceable.

"Prevention of significant deterioration area" means any area not designated as a nonattainment area in 9VAC5-20-204 for a particular pollutant and designated as such in 9VAC5-20-205.

"Proportional sampling" means sampling at a rate that produces a constant ratio of sampling rate to stack gas flow rate.

"Public hearing" means, unless indicated otherwise, an informal proceeding, similar to that provided for in § 2.2-4007.02 of the Administrative Process Act, held to afford persons an opportunity to submit views and data relative to a matter on which a decision of the board is pending.

"Reference method" means any method of sampling and analyzing for an air pollutant as described in the following EPA regulations:

1. For ambient air quality standards in 9VAC5-30 (Ambient Air Quality Standards): The applicable appendix of 40 CFR Part 50 or any method that has been designated as a reference method in accordance with 40 CFR Part 53, except that it does not include a method for which a reference designation has been canceled in accordance with 40 CFR 53.11 or 40 CFR 53.16.
2. For emission standards in 9VAC5-40 (Existing Stationary Sources) and 9VAC5-50 (New and Modified Stationary Sources): Appendix M of 40 CFR Part 51 or Appendix A of 40 CFR Part 60.
3. For emission standards in 9VAC5-60 (Hazardous Air Pollutant Sources): Appendix B of 40 CFR Part 61 or Appendix A of 40 CFR Part 63.

"Regional director" means the regional director of an administrative region of the Department of Environmental Quality or a designated representative.

"Regulation of the board" means any regulation adopted by the State Air Pollution Control Board under any provision of the Code of Virginia.

"Regulations for the Control and Abatement of Air Pollution" means 9VAC5-10 (General Definitions) through 9VAC5-80 (Permits for Stationary Sources).

"Reid vapor pressure" means the absolute vapor pressure of volatile crude oil and volatile nonviscous petroleum liquids except liquefied petroleum gases as determined by American Society for Testing and Materials publication, "Standard Test Method for Vapor Pressure of Petroleum Products (Reid Method)" (see 9VAC5-20-21).

"Run" means the net period of time during which an emission sample is collected. Unless otherwise specified, a run may be either intermittent or continuous within the limits of good engineering practice.

"Section 111(d) plan" means the portion or portions of the plan, or the most recent revision thereof, which has been approved under 40 CFR 60.27(b) in accordance with § 111(d)(1) of the federal Clean Air Act, or promulgated under 40 CFR 60.27(d) in accordance with § 111 (d)(2) of the federal Clean Air Act, and which implements the relevant requirements of the federal Clean Air Act.

"Section 111(d)/129 plan" means the portion or portions of the plan, or the most recent revision thereof, which has been approved under 40 CFR 60.27(b) in accordance with §§ 111(d)(1) and 129(b)(2) of the federal Clean Air Act, or promulgated under 40 CFR 60.27(d) in accordance with §§ 111(d)(2) and 129(b)(3) of the federal Clean Air Act, and which implements the relevant requirements of the federal Clean Air Act.

"Shutdown" means the cessation of operation of an affected facility for any purpose.

"Source" means any one or combination of the following: buildings, structures, facilities, installations, articles, machines, equipment, landcraft, watercraft, aircraft or other contrivances which contribute, or may contribute, either directly or indirectly to air pollution. Any activity by any person that contributes, or may contribute, either directly or indirectly to air pollution, including, but not limited to, open burning, generation of fugitive dust or emissions, and cleaning with abrasives or chemicals.

"Stack" means any point in a source designed to emit solids, liquids or gases into the air, including a pipe or duct, but not including flares.

"Stack in existence" means that the owner had:

1. Begun, or caused to begin, a continuous program of physical on site construction of the stack; or

2. Entered into binding agreements or contractual obligations, which could not be canceled or modified without substantial loss to the owner, to undertake a program of construction of the stack to be completed in a reasonable time.

"Standard conditions" means a temperature of 20°C (68°F) and a pressure of 760 mm of Hg (29.92 inches of Hg).

"Standard of performance" means any provision of 9VAC5-50 (New and Modified Stationary Sources) which prescribes an emissions limitation or other requirements that control air pollution emissions.

"Startup" means the setting in operation of an affected facility for any purpose.

"State enforceable" means all limitations and conditions which are enforceable by the board or department, including, but not limited to, those requirements developed pursuant to 9VAC5-20-110; requirements within any applicable regulation, order, consent agreement or variance; and any permit requirements established pursuant to 9VAC5-80 (Permits for Stationary Sources).

"State Implementation Plan" means the plan, including the most recent revision thereof, which has been approved or promulgated by the administrator, U.S. Environmental Protection Agency, under § 110 of the federal Clean Air Act, and which implements the requirements of § 110.

"Stationary source" means any building, structure, facility or installation which emits or may emit any air pollutant. A stationary source shall include all of the pollutant-emitting activities which belong to the same industrial grouping, are located on one or more contiguous or adjacent properties, and are under the control of the same person (or persons under common control) except the activities of any vessel. Pollutant-emitting activities shall be considered as part of the same industrial grouping if they belong to the same "Major Group" (i.e., which have the same two-digit code) as described in the Standard Industrial Classification Manual (see 9VAC5-20-21).

"These regulations" means 9VAC5-10 (General Definitions) through 9VAC5-80 (Permits for Stationary Sources).

"Total suspended particulate (TSP)" means particulate matter as measured by the reference method described in Appendix B of 40 CFR Part 50.

"True vapor pressure" means the equilibrium partial pressure exerted by a petroleum liquid as determined in accordance with methods described in American Petroleum Institute (API) publication, "Evaporative Loss from External Floating-Roof Tanks" (see 9VAC5-20-21). The API procedure may not be applicable to some high viscosity or high pour crudes. Available estimates of true vapor pressure may be used in special cases such as these.

"Urban area" means any area consisting of a core city with a population of 50,000 or more plus any surrounding localities

with a population density of 80 persons per square mile and designated as such in 9VAC5-20-201.

"Vapor pressure," except where specific test methods are specified, means true vapor pressure, whether measured directly, or determined from Reid vapor pressure by use of the applicable nomograph in American Petroleum Institute publication, "Evaporative Loss from Floating-Roof Tanks" (see 9VAC5-20-21).

"Virginia Air Pollution Control Law" means Chapter 13 (§ 10.1-1300 et seq.) of Title 10.1 of the Code of Virginia.

"Volatile organic compound" means any compound of carbon, excluding carbon monoxide, carbon dioxide, carbonic acid, metallic carbides or carbonates, and ammonium carbonate, which participates in atmospheric photochemical reactions.

1. This includes any such organic compounds which have been determined to have negligible photochemical reactivity other than the following:

- a. Methane;
- b. Ethane;
- c. Methylene chloride (dichloromethane);
- d. 1,1,1-trichloroethane (methyl chloroform);
- e. 1,1,2-trichloro-1,2,2-trifluoroethane (CFC-113);
- f. Trichlorofluoromethane (CFC-11);
- g. Dichlorodifluoromethane (CFC-12);
- h. Chlorodifluoromethane (H CFC-22);
- i. Trifluoromethane (H FC-23);
- j. 1,2-dichloro 1,1,2,2-tetrafluoroethane (CFC-114);
- k. Chloropentafluoroethane (CFC-115);
- l. 1,1,1-trifluoro 2,2-dichloroethane (HCFC-123);
- m. 1,1,1,2-tetrafluoroethane (HFC-134a);
- n. 1,1-dichloro 1-fluoroethane (HCFC-141b);
- o. 1-chloro 1,1-difluoroethane (HCFC-142b);
- p. 2-chloro-1,1,1,2-tetrafluoroethane (HCFC-124);
- q. Pentafluoroethane (HFC-125);
- r. 1,1,2,2-tetrafluoroethane (HFC-134);
- s. 1,1,1-trifluoroethane (HFC-143a);
- t. 1,1-difluoroethane (HFC-152a);
- u. Parachlorobenzotrifluoride (PCBTF);
- v. Cyclic, branched, or linear completely methylated siloxanes;
- w. Acetone;
- x. Perchloroethylene (tetrachloroethylene);
- y. 3,3-dichloro-1,1,1,2,2-pentafluoropropane (HCFC-225ca);
- z. 1,3-dichloro-1,1,2,2,3-pentafluoropropane (HCFC-225cb);

Regulations

- aa. 1,1,1,2,3,4,4,5,5,5-decafluoropentane (HFC 43-10mee);
- bb. Difluoromethane (HFC-32);
- cc. Ethylfluoride (HFC-161);
- dd. 1,1,1,3,3,3-hexafluoropropane (HFC-236fa);
- ee. 1,1,2,2,3-pentafluoropropane (HFC-245ca);
- ff. 1,1,2,3,3-pentafluoropropane (HFC-245ea);
- gg. 1,1,1,2,3-pentafluoropropane (HFC-245eb);
- hh. 1,1,1,3,3-pentafluoropropane (HFC-245fa);
- ii. 1,1,1,2,3,3-hexafluoropropane (HFC-236ea);
- jj. 1,1,1,3,3-pentafluorobutane (HFC-365mfc);
- kk. Chlorofluoromethane (HCFC-31);
- ll. 1 chloro-1-fluoroethane (HCFC-151a);
- mm. 1,2-dichloro-1,1,2-trifluoroethane (HCFC-123a);
- nn. 1,1,1,2,2,3,3,4,4-nonafluoro-4-methoxy-butane (C₄F₉OCH₃ or HFE-7100);
- oo. 2-(difluoromethoxymethyl)-1,1,1,2,3,3,3-heptafluoropropane ((CF₃)₂CF₂OCH₃);
- pp. 1-ethoxy-1,1,2,2,3,3,4,4,4-nonafluorobutane (C₄F₉OC₂H₅ or HFE-7200);
- qq. 2-(ethoxydifluoromethyl)-1,1,1,2,3,3,3-heptafluoropropane ((CF₃)₂CF₂OC₂H₅);
- rr. Methyl acetate; ss. 1,1,1,2,2,3,3-heptafluoro-3-methoxy-propane (n-C₃F₇OCH₃) (HFE-7000);
- tt. 3-ethoxy-1,1,1,2,3,4,4,5,5,6,6,6-dodecafluoro-2-(trifluoromethyl) hexane (HFE-7500);
- uu. 1,1,1,2,3,3,3-heptafluoropropane (HFC 227ea);
- vv. methyl formate (HCOOCH₃);
- ww. (1) 1,1,1,2,2,3,4,5,5,5-decafluoro-3-methoxy-4-trifluoromethyl-pentane (HFE-7300);
- xx. propylene carbonate;
- yy. dimethyl carbonate; and
- zz. Perfluorocarbon compounds which fall into these classes:
 - (1) Cyclic, branched, or linear, completely fluorinated alkanes;
 - (2) Cyclic, branched, or linear, completely fluorinated ethers with no unsaturations;
 - (3) Cyclic, branched, or linear, completely fluorinated tertiary amines with no unsaturations; and
 - (4) Sulfur containing perfluorocarbons with no unsaturations and with sulfur bonds only to carbon and fluorine.

2. For purposes of determining compliance with emissions standards, volatile organic compounds shall be measured by the appropriate reference method in accordance with the provisions of 9VAC5-40-30 or 9VAC5-50-30, as applicable. Where such a method also measures

compounds with negligible photochemical reactivity, these negligibly reactive compounds may be excluded as a volatile organic compound if the amount of such compounds is accurately quantified, and such exclusion is approved by the board.

3. As a precondition to excluding these compounds as volatile organic compounds or at any time thereafter, the board may require an owner to provide monitoring or testing methods and results demonstrating, to the satisfaction of the board, the amount of negligibly reactive compounds in the emissions of the source.

4. Exclusion of the above compounds in this definition in effect exempts such compounds from the provisions of emission standards for volatile organic compounds. The compounds are exempted on the basis of being so inactive that they will not contribute significantly to the formation of ozone in the troposphere. However, this exemption does not extend to other properties of the exempted compounds which, at some future date, may require regulation and limitation of their use in accordance with requirements of the federal Clean Air Act.

5. The following compound is a VOC for purposes of all recordkeeping, emissions reporting, photochemical dispersion modeling and inventory requirements that apply to VOCs and shall be uniquely identified in emission reports, but is not a VOC for purposes of VOC emission standards, VOC emissions limitations, or VOC content requirements: t-butyl acetate.

"Welfare" means that language referring to effects on welfare includes, but is not limited to, effects on soils, water, crops, vegetation, man-made materials, animals, wildlife, weather, visibility and climate, damage to and deterioration of property, and hazards to transportation, as well as effects on economic values and on personal comfort and well-being.

9VAC5-170-200. Appeal procedures.

A. An owner or other party significantly affected by an action of the board taken without a formal hearing, or by inaction of the board, may request a formal hearing in accordance with § 2.2-4020 of the Administrative Process Act, provided a petition requesting a formal hearing is filed with the board. In cases involving actions of the board, the petition shall be filed within 30 days after notice of the action is mailed, by postal or electronic delivery, or delivered to the owner or party requesting notification of the action.

B. Prior to a formal hearing, an informal fact finding shall be held pursuant to § 2.2-4019 of the Administrative Process Act unless waived by the named party and the board.

C. A decision of the board resulting from a formal hearing shall constitute the final decision of the board.

D. Judicial review of a final decision of the board shall be afforded in accordance with § 10.1-1318 of the Virginia Air Pollution Control Law and § 2.2-4026 of the Administrative Process Act.

E. Nothing in this section shall prevent disposition of a case by consent.

F. A petition for a formal hearing or a notice or petition for an appeal by itself shall not constitute a stay of decision or action.

G. A party significantly affected by a decision of the director may request that the board exercise its authority for direct consideration of the issue. The request shall be filed within 30 days after the decision is rendered and shall contain reasons for the request.

H. The submittal of the request by itself shall not constitute a stay of decision. A stay of decision shall be sought through appropriate legal channels.

I. The director has final authority to adjudicate contested decisions of subordinates delegated powers by the director prior to appeal of decisions to the circuit court or consideration by the board.

VA.R. Doc. No. R13-3774; Filed July 10, 2013, 11:51 a.m.

Final Regulation

REGISTRAR'S NOTICE: The following regulatory action is exempt from the Administrative Process Act in accordance with § 2.2-4006 A 4 c of the Code of Virginia, which excludes regulations that are necessary to meet the requirements of federal law or regulations provided such regulations do not differ materially from those required by federal law or regulation. The State Air Pollution Control Board will receive, consider, and respond to petitions by any interested person at any time with respect to reconsideration or revision.

Titles of Regulations: **9VAC5-20. General Provisions (amending 9VAC5-20-21) (Rev. E13).**

9VAC5-40. Existing Stationary Sources (amending 9VAC5-40-6250, 9VAC5-40-6260, 9VAC5-40-6270, 9VAC5-40-6370 through 9VAC5-40-6490, 9VAC5-40-6510; adding 9VAC5-40-6520; repealing 9VAC5-40-6280 through 9VAC5-40-6350, 9VAC5-40-6421, 9VAC5-40-6422) (Rev. E13).

Statutory Authority: § 10.1-1308 of the Code of Virginia; federal Clean Air Act (§§ 110, 111, 123, 129, 171, 172, and 182); 40 CFR Parts 51 and 60.

Effective Date: August 28, 2013.

Agency Contact: Karen G. Sabasteanski, Department of Environmental Quality, 629 East Main Street, P.O. Box 1105, Richmond, VA 23218, telephone (804) 698-4426, FAX (804) 698-4510, TTY (804) 698-4021, or email karen.sabasteanski@deq.virginia.gov.

Summary:

Designated pollutants are pollutants for which new source performance standards have been established under § 111(b) of the federal Clean Air Act (Act). A designated facility is an existing facility that emits a designated pollutant and that would be subject to a standard of

performance for that pollutant if the facility were new. The Act requires the U.S. Environmental Protection Agency (EPA) to establish procedures for states to submit plans to control facilities that emit designated pollutants. Section 129 of the Act requires that EPA establish performance standards and other requirements pursuant to §§ 111 and 129 of the Act for each category of solid waste incineration units. Such standards include emissions limitations and other requirements applicable to new units and guidelines and other requirements applicable to existing units. It also requires states to submit plans for these sources. Subpart B provides that EPA will publish guideline documents for development of state emission standards after promulgation of any standard of performance for designated pollutants. EPA amended its emission guidelines for commercial/industrial solid waste incinerators in the Federal Register on February 7, 2013 (78 FR 9112). In order to implement the emissions guidelines, it is necessary for Virginia to amend its state regulation containing those limits.

9VAC5-20-21. Documents incorporated by reference.

A. The Administrative Process Act and Virginia Register Act provide that state regulations may incorporate documents by reference. Throughout these regulations, documents of the types specified below have been incorporated by reference.

1. United States Code.
2. Code of Virginia.
3. Code of Federal Regulations.
4. Federal Register.
5. Technical and scientific reference documents.

Additional information on key federal regulations and nonstatutory documents incorporated by reference and their availability may be found in subsection E of this section.

B. Any reference in these regulations to any provision of the Code of Federal Regulations (CFR) shall be considered as the adoption by reference of that provision. The specific version of the provision adopted by reference shall be that contained in the CFR ~~(2012)~~ (2013) in effect July 1, ~~2012~~ 2013. In making reference to the Code of Federal Regulations, 40 CFR Part 35 means Part 35 of Title 40 of the Code of Federal Regulations; 40 CFR 35.20 means § 35.20 in Part 35 of Title 40 of the Code of Federal Regulations.

C. Failure to include in this section any document referenced in the regulations shall not invalidate the applicability of the referenced document.

D. Copies of materials incorporated by reference in this section may be examined by the public at the central office of the Department of Environmental Quality, Eighth Floor, 629 East Main Street, Richmond, Virginia, between 8:30 a.m. and 4:30 p.m. of each business day.

Regulations

E. Information on federal regulations and nonstatutory documents incorporated by reference and their availability may be found below in this subsection.

1. Code of Federal Regulations.

a. The provisions specified below from the Code of Federal Regulations (CFR) are incorporated herein by reference.

(1) 40 CFR Part 50 -- National Primary and Secondary Ambient Air Quality Standards.

(a) Appendix A-1 -- Reference Measurement Principle and Calibration Procedure for the Measurement of Sulfur Dioxide in the Atmosphere (Ultraviolet Fluorescence Method).

(b) Appendix A-2 -- Reference Method for the Determination of Sulfur Dioxide in the Atmosphere (Pararosaniline Method).

(c) Appendix B -- Reference Method for the Determination of Suspended Particulate Matter in the Atmosphere (High-Volume Method).

(d) Appendix C -- Measurement Principle and Calibration Procedure for the Continuous Measurement of Carbon Monoxide in the Atmosphere (Non-Dispersive Infrared Photometry).

(e) Appendix D -- Measurement Principle and Calibration Procedure for the Measurement of Ozone in the Atmosphere.

(f) Appendix E -- Reserved.

(g) Appendix F -- Measurement Principle and Calibration Procedure for the Measurement of Nitrogen Dioxide in the Atmosphere (Gas Phase Chemiluminescence).

(h) Appendix G -- Reference Method for the Determination of Lead in Suspended Particulate Matter Collected from Ambient Air.

(i) Appendix H -- Interpretation of the National Ambient Air Quality Standards for Ozone.

(j) Appendix I -- Interpretation of the 8-Hour Primary and Secondary National Ambient Air Quality Standards for Ozone.

(k) Appendix J -- Reference Method for the Determination of Particulate Matter as PM₁₀ in the Atmosphere.

(l) Appendix K -- Interpretation of the National Ambient Air Quality Standards for Particulate Matter.

(m) Appendix L -- Reference Method for the Determination of Fine Particulate Matter as PM_{2.5} in the Atmosphere.

(n) Appendix M -- Reserved.

(o) Appendix N -- Interpretation of the National Ambient Air Quality Standards for PM_{2.5}.

(p) Appendix O -- Reference Method for the Determination of Coarse Particulate Matter as PM in the Atmosphere.

(q) Appendix P -- Interpretation of the Primary and Secondary National Ambient Air Quality Standards for Ozone.

(r) Appendix Q -- Reference Method for the Determination of Lead in Suspended Particulate Matter as PM₁₀ Collected from Ambient Air.

(s) Appendix R -- Interpretation of the National Ambient Air Quality Standards for Lead.

(t) Appendix S -- Interpretation of the Primary National Ambient Air Quality Standards for Oxides of Nitrogen (Nitrogen Dioxide).

(u) Appendix T -- Interpretation of the Primary National Ambient Air Quality Standards for Oxides of Sulfur (Sulfur Dioxide).

(2) 40 CFR Part 51 -- Requirements for Preparation, Adoption, and Submittal of Implementation Plans.

(a) Appendix M -- Recommended Test Methods for State Implementation Plans.

(b) Appendix S -- Emission Offset Interpretive Ruling.

(c) Appendix W -- Guideline on Air Quality Models (Revised).

(d) Appendix Y -- Guidelines for BART Determinations Under the Regional Haze Rule.

(3) 40 CFR Part 55 -- Outer Continental Shelf Air Regulations.

(4) 40 CFR Part 58 -- Ambient Air Quality Surveillance.

Appendix A -- Quality Assurance Requirements for SLAMS, SPMs and PSD Air Monitoring.

(5) 40 CFR Part 59 -- National Volatile Organic Compound Emission Standards for Consumer and Commercial Products.

(a) Subpart C -- National Volatile Organic Compound Emission Standards for Consumer Products.

(b) Subpart D -- National Volatile Organic Compound Emission Standards for Architectural Coatings, Appendix A -- Determination of Volatile Matter Content of Methacrylate Multicomponent Coatings Used as Traffic Marking Coatings.

(6) 40 CFR Part 60 -- Standards of Performance for New Stationary Sources.

The specific provisions of 40 CFR Part 60 incorporated by reference are found in Article 5 (9VAC5-50-400 et seq.) of Part II of 9VAC5-50 (New and Modified Sources).

(7) 40 CFR Part 61 -- National Emission Standards for Hazardous Air Pollutants.

The specific provisions of 40 CFR Part 61 incorporated by reference are found in Article 1 (9VAC5-60-60 et seq.) of Part II of 9VAC5-60 (Hazardous Air Pollutant Sources).

(8) 40 CFR Part 63 -- National Emission Standards for Hazardous Air Pollutants for Source Categories.

The specific provisions of 40 CFR Part 63 incorporated by reference are found in Article 2 (9VAC5-60-90 et seq.) of Part II of 9VAC5-60 (Hazardous Air Pollutant Sources).

(9) 40 CFR Part 64 -- Compliance Assurance Monitoring.

(10) 40 CFR Part 72 -- Permits Regulation.

(11) 40 CFR Part 73 -- Sulfur Dioxide Allowance System.

(12) 40 CFR Part 74 -- Sulfur Dioxide Opt-Ins.

(13) 40 CFR Part 75 -- Continuous Emission Monitoring.

(14) 40 CFR Part 76 -- Acid Rain Nitrogen Oxides Emission Reduction Program.

(15) 40 CFR Part 77 -- Excess Emissions.

(16) 40 CFR Part 78 -- Appeal Procedures for Acid Rain Program.

(17) 40 CFR Part 152 Subpart I -- Classification of Pesticides.

(18) 49 CFR Part 172 -- Hazardous Materials Table. Special Provisions, Hazardous Materials Communications, Emergency Response Information, and Training Requirements, Subpart E, Labeling.

(19) 29 CFR Part 1926 Subpart F -- Fire Protection and Prevention.

b. Copies may be obtained from: Superintendent of Documents, P.O. Box 371954, Pittsburgh, Pennsylvania 15250-7954; phone (202) 783-3238.

2. U.S. Environmental Protection Agency.

a. The following documents from the U.S. Environmental Protection Agency are incorporated herein by reference:

(1) Reich Test, Atmospheric Emissions from Sulfuric Acid Manufacturing Processes, Public Health Service Publication No. PB82250721, 1980.

(2) Compilation of Air Pollutant Emission Factors (AP-42). Volume I: Stationary and Area Sources, stock number 055-000-00500-1, 1995; Supplement A, stock number 055-000-00551-6, 1996; Supplement B, stock number 055-000-00565, 1997; Supplement C, stock number 055-000-00587-7, 1997; Supplement D, 1998; Supplement E, 1999.

(3) "Guidelines for Determining Capture Efficiency" (GD-35), Emissions Monitoring and Analysis Division, Office of Air Quality Planning and Standards, January 9, 1995.

b. Copies of the document identified in subdivision E 2 a (1) of this subdivision, and Volume I and Supplements A through C of the document identified in subdivision E 2 a (2) of this subdivision, may be obtained from: U.S. Department of Commerce, National Technical Information Service, 5285 Port Royal Road, Springfield, Virginia 22161; phone 1-800-553-6847. Copies of Supplements D and E of the document identified in subdivision E 2 a (2) of this subdivision may be obtained online from EPA's Technology Transfer Network at <http://www.epa.gov/ttn/index.html>. Copies of the document identified in subdivision E 2 a (3) of this subdivision are only available online from EPA's Technology Transfer Network at <http://www.epa.gov/ttn/emc/guidInd.html>.

3. U.S. government.

a. The following document from the U.S. government is incorporated herein by reference: Standard Industrial Classification Manual, 1987 (U.S. Government Printing Office stock number 041-001-00-314-2).

b. Copies may be obtained from: Superintendent of Documents, P.O. Box 371954, Pittsburgh, Pennsylvania 15250-7954; phone (202) 512-1800.

4. American Society for Testing and Materials (ASTM).

a. The documents specified below from the American Society for Testing and Materials are incorporated herein by reference.

(1) D323-99a, "Standard Test Method for Vapor Pressure of Petroleum Products (Reid Method)."

(2) D97-96a, "Standard Test Method for Pour Point of Petroleum Products."

(3) D129-00, "Standard Test Method for Sulfur in Petroleum Products (General Bomb Method)."

(4) D388-99, "Standard Classification of Coals by Rank."

(5) D396-98, "Standard Specification for Fuel Oils."

(6) D975-98b, "Standard Specification for Diesel Fuel Oils."

(7) D1072-90(1999), "Standard Test Method for Total Sulfur in Fuel Gases."

(8) D1265-97, "Standard Practice for Sampling Liquefied Petroleum (LP) Gases (Manual Method)."

(9) D2622-98, "Standard Test Method for Sulfur in Petroleum Products by Wavelength Dispersive X-Ray Fluorescence Spectrometry."

(10) D4057-95(2000), "Standard Practice for Manual Sampling of Petroleum and Petroleum Products."

(11) D4294-98, "Standard Test Method for Sulfur in Petroleum and Petroleum Products by Energy-Dispersive X-Ray Fluorescence Spectroscopy."

(12) D523-89, "Standard Test Method for Specular Gloss" (1999).

Regulations

(13) D1613-02, "Standard Test Method for Acidity in Volatile Solvents and Chemical Intermediates Used in Paint, Varnish, Lacquer and Related Products" (2002).

(14) D1640-95, "Standard Test Methods for Drying, Curing, or Film Formation of Organic Coatings at Room Temperature" (1999).

(15) E119-00a, "Standard Test Methods for Fire Tests of Building Construction Materials" (2000).

(16) E84-01, "Standard Test Method for Surface Burning Characteristics of Building Construction Materials" (2001).

(17) D4214-98, "Standard Test Methods for Evaluating the Degree of Chalking of Exterior Paint Films" (1998).

(18) D86-04b, "Standard Test Method for Distillation of Petroleum Products at Atmospheric Pressure" (2004).

(19) D4359-90, "Standard Test Method for Determining Whether a Material is a Liquid or a Solid" (reapproved 2000).

(20) E260-96, "Standard Practice for Packed Column Gas Chromatography" (reapproved 2001).

(21) D3912-95, "Standard Test Method for Chemical Resistance of Coatings Used in Light-Water Nuclear Power Plants" (reapproved 2001).

(22) D4082-02, "Standard Test Method for Effects of Gamma Radiation on Coatings for Use in Light-Water Nuclear Power Plants."

(23) F852-99, "Standard Specification for Portable Gasoline Containers for Consumer Use" (reapproved 2006).

(24) F976-02, "Standard Specification for Portable Kerosine and Diesel Containers for Consumer Use."

(25) D4457-02, "Standard Test Method for Determination of Dichloromethane and 1,1,1-Trichloroethane in Paints and Coatings by Direct Injection into a Gas Chromatograph" (reapproved 2008).

(26) D3792-05, "Standard Test Method for Water Content of Coatings by Direct Injection Into a Gas Chromatograph."

(27) D2879-97, "Standard Test Method for Vapor Pressure-Temperature Relationship and Initial Decomposition Temperature of Liquids by Isoteniscope" (reapproved 2007).

b. Copies may be obtained from: American Society for Testing Materials, 100 Barr Harbor Drive, West Conshohocken, Pennsylvania 19428-2959; phone (610) 832-9585.

5. American Petroleum Institute (API).

a. The following document from the American Petroleum Institute is incorporated herein by reference: *Evaporative Loss from Floating Roof Tanks*, API MPMS Chapter 19, April 1, 1997.

b. Copies may be obtained from: American Petroleum Institute, 1220 L Street, Northwest, Washington, D.C. 20005; phone (202) 682-8000.

6. American Conference of Governmental Industrial Hygienists (ACGIH).

a. The following document from the ACGIH is incorporated herein by reference: *1991-1992 Threshold Limit Values for Chemical Substances and Physical Agents and Biological Exposure Indices (ACGIH Handbook)*.

b. Copies may be obtained from: ACGIH, 1330 Kemper Meadow Drive, Suite 600, Cincinnati, Ohio 45240; phone (513) 742-2020.

7. National Fire Prevention Association (NFPA).

a. The documents specified below from the National Fire Prevention Association are incorporated herein by reference.

(1) NFPA 385, *Standard for Tank Vehicles for Flammable and Combustible Liquids*, 2000 Edition.

(2) NFPA 30, *Flammable and Combustible Liquids Code*, 2000 Edition.

(3) NFPA 30A, *Code for Motor Fuel Dispensing Facilities and Repair Garages*, 2000 Edition.

b. Copies may be obtained from the National Fire Prevention Association, One Batterymarch Park, P.O. Box 9101, Quincy, Massachusetts 02269-9101; phone (617) 770-3000.

8. American Society of Mechanical Engineers (ASME).

a. The documents specified below from the American Society of Mechanical Engineers are incorporated herein by reference.

(1) ASME Power Test Codes: *Test Code for Steam Generating Units*, Power Test Code 4.1-1964 (R1991).

(2) ASME Interim Supplement 19.5 on Instruments and Apparatus: *Application, Part II of Fluid Meters*, 6th edition (1971).

(3) *Standard for the Qualification and Certification of Resource Recovery Facility Operators*, ASME QRO-1-1994.

b. Copies may be obtained from the American Society of Mechanical Engineers, Three Park Avenue, New York, New York 10016; phone (800) 843-2763.

9. American Hospital Association (AHA).

a. The following document from the American Hospital Association is incorporated herein by reference: *An Ounce of Prevention: Waste Reduction Strategies for Health Care Facilities*, AHA Catalog no. W5-057007, 1993.

b. Copies may be obtained from: American Hospital Association, One North Franklin, Chicago, IL 60606; phone (800) 242-2626.

10. Bay Area Air Quality Management District (BAAQMD).

a. The following documents from the Bay Area Air Quality Management District are incorporated herein by reference:

(1) Method 41, "Determination of Volatile Organic Compounds in Solvent-Based Coatings and Related Materials Containing Parachlorobenzotrifluoride" (December 20, 1995).

(2) Method 43, "Determination of Volatile Methylsiloxanes in Solvent-Based Coatings, Inks, and Related Materials" (November 6, 1996).

b. Copies may be obtained from: Bay Area Air Quality Management District, 939 Ellis Street, San Francisco, CA 94109, phone (415) 771-6000.

11. South Coast Air Quality Management District (SCAQMD).

a. The following documents from the South Coast Air Quality Management District are incorporated herein by reference:

(1) Method 303-91, "Determination of Exempt Compounds," in Manual SSMLLABM, "Laboratory Methods of Analysis for Enforcement Samples" (1996).

(2) Method 318-95, "Determination of Weight Percent Elemental Metal in Coatings by X-Ray Diffraction," in Manual SSMLLABM, "Laboratory Methods of Analysis for Enforcement Samples" (1996).

(3) Rule 1174 Ignition Method Compliance Certification Protocol (February 28, 1991).

(4) Method 304-91, "Determination of Volatile Organic Compounds (VOC) in Various Materials," in Manual SSMLLABM, "Laboratory Methods of Analysis for Enforcement Samples" (1996).

(5) Method 316A-92, "Determination of Volatile Organic Compounds (VOC) in Materials Used for Pipes and Fittings" in Manual SSMLLABM, "Laboratory Methods of Analysis for Enforcement Samples" (1996).

(6) "General Test Method for Determining Solvent Losses from Spray Gun Cleaning Systems," October 3, 1989.

b. Copies may be obtained from: South Coast Air Quality Management District, 21865 E. Copley Drive, Diamond Bar, CA 91765, phone (909) 396-2000.

12. California Air Resources Board (CARB).

a. The following documents from the California Air Resources Board are incorporated herein by reference:

(1) Test Method 510, "Automatic Shut-Off Test Procedure for Spill-Proof Systems and Spill-Proof Spouts" (July 6, 2000).

(2) Test Method 511, "Automatic Closure Test Procedure for Spill-Proof Systems and Spill-Proof Spouts" (July 6, 2000).

(3) Method 100, "Procedures for Continuous Gaseous Emission Stack Sampling" (July 28, 1997).

(4) Test Method 513, "Determination of Permeation Rate for Spill-Proof Systems" (July 6, 2000).

(5) Method 310, "Determination of Volatile Organic Compounds (VOC) in Consumer Products and Reactive Organic Compounds in Aerosol Coating Products (Including Appendices A and B)" (May 5, 2005).

(6) California Code of Regulations, Title 17, Division 3, Chapter 1, Subchapter 8.5, Article 1, § 94503.5 (2003).

(7) California Code of Regulations, Title 17, Division 3, Chapter 1, Subchapter 8.5, Article 2, §§ 94509 and 94511 (2003).

(8) California Code of Regulations, Title 17, Division 3, Chapter 1, Subchapter 8.5, Article 4, §§ 94540-94555 (2003).

(9) "Certification Procedure 501 for Portable Fuel Containers and Spill-Proof Spouts, CP-501" (July 26, 2006).

(10) "Test Procedure for Determining Integrity of Spill-Proof Spouts and Spill-Proof Systems, TP-501" (July 26, 2006).

(11) "Test Procedure for Determining Diurnal Emissions from Portable Fuel Containers, TP-502" (July 26, 2006).

b. Copies may be obtained from: California Air Resources Board, P.O. Box 2815, Sacramento, CA 95812, phone (906) 322-3260 or (906) 322-2990.

13. American Architectural Manufacturers Association.

a. The following documents from the American Architectural Manufacturers Association are incorporated herein by reference:

(1) Voluntary Specification 2604-02, "Performance Requirements and Test Procedures for High Performance Organic Coatings on Aluminum Extrusions and Panels" (2002).

(2) Voluntary Specification 2605-02, "Performance Requirements and Test Procedures for Superior Performing Organic Coatings on Aluminum Extrusions and Panels" (2002).

b. Copies may be obtained from: American Architectural Manufacturers Association, 1827 Walden Office Square, Suite 550, Schaumburg, IL 60173, phone (847) 303-5664.

14. American Furniture Manufacturers Association.

a. The following document from the American Furniture Manufacturers Association is incorporated herein by reference: Joint Industry Fabrics Standards Committee,

Regulations

Woven and Knit Residential Upholstery Fabric Standards and Guidelines (January 2001).

b. Copies may be obtained from: American Furniture Manufacturers Association, P.O. Box HP-7, High Point, NC 27261; phone (336) 884-5000.

Article 45

Emission Standards for Commercial/Industrial Solid Waste Incinerators (Rule 4-45)

9VAC5-40-6250. Applicability and designation of affected facility.

A. ~~Except as provided in subsections C and D of this section, the~~ The affected facilities to which the provisions of this article apply are (i) commercial/industrial solid waste incinerator (CISWI) units that commenced construction on or before November 30, 1999, (ii) incinerators that commenced construction after November 30, 1999, but no later than June 4, 2010, or commenced modification after June 1, 2001, but no later than August 7, 2013; or (iii) CISWI units other than incinerator units that commenced construction on or before June 4, 2010, or commenced modification after June 4, 2010, but no later than August 7, 2013.

B. The provisions of this article apply throughout the Commonwealth of Virginia.

C. Exempted from the provisions of this article are ~~the following:~~ those units that meet the criteria listed in 40 CFR 60.2555.

~~1. Pathological waste incineration units burning 90% or more by weight (on a calendar quarter basis and excluding the weight of auxiliary fuel and combustion air) of any combination of pathological waste, low-level radioactive waste, or chemotherapeutic waste if the owner:~~

- ~~a. Notifies the board that the unit meets these criteria, and~~
- ~~b. Keeps records on a calendar quarter basis of the weight of pathological waste, low level radioactive waste, or chemotherapeutic waste burned, and the weight of all other fuels and wastes burned in the unit.~~

~~2. Agricultural waste incineration units burning 90% or more by weight (on a calendar quarter basis and excluding the weight of auxiliary fuel and combustion air) of agricultural wastes if the owner:~~

- ~~a. Notifies the board that the unit meets these criteria, and~~
- ~~b. Keeps records on a calendar quarter basis of the weight of agricultural waste burned, and the weight of all other fuels and wastes burned in the unit.~~

~~3. Municipal waste combustion units that meet either of the following:~~

- ~~a. Are regulated under subparts Ea, Eb, or AAAA of 40 CFR Part 60 or Article 46 (9VAC5 40-6550 et seq.) or Article 54 (9VAC5 40-7950 et seq.) of Part II of 9VAC5 Chapter 40.~~
- ~~b. Burn greater than 30% municipal solid waste or refuse derived fuel, as defined in Subparts Ea, Eb and~~

~~AAAA of 40 CFR Part 60, and Article 46 (9VAC5 40-6550 et seq.) of Part II of 9VAC5 Chapter 40, and have the capacity to burn less than 35 tons (32 megagrams) per day of municipal solid waste or refuse derived fuel, if the owner:~~

- ~~(1) Notifies the board that the unit meets these criteria, and~~
- ~~(2) Keeps records on a calendar quarter basis of the weight of municipal solid waste burned, and the weight of all other fuels and wastes burned in the unit.~~

~~4. Medical waste incineration units regulated under subpart Ee of 40 CFR Part 60 or Article 44 (9VAC5 40-6000 et seq.) of Part II of 9VAC5 Chapter 40.~~

~~5. Small power production facility units if:~~

- ~~a. The unit qualifies as a small power production facility under § 3(17)(C) of the Federal Power Act (16 USC § 796(17)(C));~~
- ~~b. The unit burns homogeneous waste (not including refuse derived fuel) to produce electricity; and~~
- ~~c. The owner notifies the board that the unit meets all of these criteria.~~

~~6. Cogeneration facility units if:~~

- ~~a. The unit qualifies as a cogeneration facility under § 3(18)(B) of the Federal Power Act (16 USC § 796(18)(B));~~
- ~~b. The unit burns homogeneous waste (not including refuse derived fuel) to produce electricity and steam or other forms of energy used for industrial, commercial, heating, or cooling purposes; and~~
- ~~c. The owner notifies the board that the unit meets all of these criteria.~~

~~7. Hazardous waste combustion units that are either:~~

- ~~a. Required to obtain a permit under § 3005 of the Solid Waste Disposal Act (42 USC § 6901 et seq.); or~~
- ~~b. Regulated under subpart EEE of 40 CFR Part 63.~~

~~8. Materials recovery units that combust waste for the primary purpose of recovering metals, such as primary and secondary smelters.~~

~~9. Air curtain incinerators that burn only (i) 100% wood waste, (ii) 100% clean lumber or (iii) 100% mixture of only any combination of wood waste, clean lumber, or yard waste shall meet the requirements under 9VAC5 40-6490.~~

~~10. Cyclonic barrel burners.~~

~~11. Rack, part, and drum reclamation units.~~

~~12. Cement kilns regulated under subpart LLL of 40 CFR Part 63.~~

~~13. Sewage sludge incinerator units regulated under subpart O of 40 CFR Part 60.~~

14. Chemical recovery units burning materials to recover chemical constituents or to produce chemical compounds where there is an existing commercial market for such recovered chemical constituents or compounds.

a. Except as provided in subdivision 14 b of this subsection, the following types of units are considered chemical recovery units.

(1) Units burning only pulping liquors (i.e., black liquor) that are reclaimed in a pulping liquor recovery process and reused in the pulping process.

(2) Units burning only spent sulfuric acid used to produce virgin sulfuric acid.

(3) Units burning only wood or coal feedstock for the production of charcoal.

(4) Units burning only manufacturing byproduct streams or residues or both containing catalyst metals that are reclaimed and reused as catalysts or used to produce commercial grade catalysts.

(5) Units burning only coke to produce purified carbon monoxide that is used as an intermediate in the production of other chemical compounds.

(6) Units burning only hydrocarbon liquids or solids to produce hydrogen, carbon monoxide, synthesis gas, or other gases for use in other manufacturing processes.

(7) Units burning only photographic film to recover silver.

b. If a chemical recovery unit is not listed in subdivision 14 a of this subsection, the owner of the unit may petition the board to add the unit to the list. The petition shall contain the following:

(1) A description of the source of the materials being burned.

(2) A description of the composition of the materials being burned, highlighting the chemical constituents in these materials that are recovered.

(3) A description (including a process flow diagram) of the process in which the materials are burned, highlighting the type, design, and operation of the equipment used in this process.

(4) A description (including a process flow diagram) of the chemical constituent recovery process, highlighting the type, design, and operation of the equipment used in this process.

(5) A description of the commercial markets for the recovered chemical constituents and their use.

(6) The composition of the recovered chemical constituents and the composition of these chemical constituents as they are bought and sold in commercial markets.

e. Until the board approves the petition, the incineration unit is subject to this article.

d. If a petition is approved, the board will amend subdivision 14 a of this subsection to add the unit to the list of chemical recovery units.

15. Laboratory analysis units that burn samples of materials for the purpose of chemical or physical analysis.

D. The provisions of this article do not apply to a CISWI unit if the owner makes changes that meet the definition of modification or reconstruction on or after June 1, 2001 August 7, 2013, at which point the CISWI unit becomes subject to subpart CCCC of 40 CFR Part 60.

E. If the owner makes physical or operational changes to an existing CISWI unit primarily to comply with this article, subpart CCCC of 40 CFR Part 60 does not apply to that unit. Such changes do not qualify as modifications or reconstructions under subpart CCCC of 40 CFR Part 60.

F. Each owner shall submit an application for a federal operating permit no later than December 1, 2003. If the unit is subject to the federal operating permit program as a result of some triggering requirements other than this article (for example, being a major source), then the unit may be required to apply for and obtain a federal operating permit prior to the deadline in this subsection. If more than one requirement triggers the requirement to apply for a federal operating permit, the 12-month timeframe for filing a permit application is triggered by the requirement that first causes the source to be subject to the federal operating permit program in accordance with the provisions of 40 CFR 60.2805. Owners to whom this section applies should contact the appropriate regional office for guidance on applying for a federal (Title V) operating permit.

G. The provisions of 40 CFR Part 60 and Part 63 cited in this article are applicable only to the extent that they are incorporated by reference in Article 5 (9VAC5-50-400 et seq.) of Part II of 9VAC5 Chapter 50 and Article 2 (9VAC5-60-90 et seq.) of Part II of 9VAC5 Chapter 60.

H. G. The requirement of subdivision C-7 of this section under 40 CFR 60.2555(g)(1) with regard to obtaining a permit under § 3005 of the Solid Waste Disposal Act (42 USC § 6901 et seq.) may be met by obtaining a permit from the department as required by 9VAC20 Chapter 60 9VAC5-60 (Virginia Hazardous Waste Management Regulations).

9VAC5-40-6260. Definitions.

A. For the purpose of applying this article in the context of the Regulations for the Control and Abatement of Air Pollution and related uses, the words or terms shall have the meanings given them in subsection C of this section.

B. As used in this article, all terms not defined herein shall have the meanings given them in 9VAC5 Chapter 10 9VAC5-10 (General Definitions), unless otherwise required by context.

C. Terms defined. Terms shall have the meaning given them in 40 CFR 60.2875, except for the following:

Regulations

"Administrator" means the board.

"Table 1" means 9VAC5-40-6420.

"You" means the owner of an affected CISWI unit.

"Agricultural waste" means vegetative agricultural materials such as nut and grain hulls and chaff (e.g., almond, walnut, peanut, rice, and wheat), bagasse, orchard prunings, corn stalks, coffee bean hulls and grounds, and other vegetative waste materials generated as a result of agricultural operations.

"Air curtain incinerator" means an incinerator that operates by forcefully projecting a curtain of air across an open chamber or pit in which combustion occurs. Incinerators of this type can be constructed above or below ground and with or without refractory walls and floor. Air curtain incinerators are not to be confused with conventional combustion devices with enclosed fireboxes and controlled air technology such as mass burn, modular, and fluidized bed combustors.

"Auxiliary fuel" means natural gas, liquefied petroleum gas, fuel oil, or diesel fuel.

"Bag leak detection system" means an instrument that is capable of monitoring particulate matter loadings in the exhaust of a fabric filter (i.e., baghouse) in order to detect bag failures. A bag leak detection system includes, but is not limited to, an instrument that operates on triboelectric, light scattering, light transmittance, or other principle to monitor relative particulate matter loadings.

"Baseline compliance date" means the earlier of (i) December 1, 2003, or (ii) the date of publication of the CISWI federal plan (Subpart III of 40 CFR Part 62) in the Federal Register.

"Calendar quarter" means three consecutive months, not overlapping, beginning on January 1, April 1, July 1, or October 1.

"Calendar year" means 365 consecutive days (or 366 consecutive days in leap years) starting on January 1 and ending on December 31.

"Chemotherapeutic waste" means waste material resulting from the production or use of antineoplastic agents used for the purpose of stopping or reversing the growth of malignant cells.

"Clean lumber" means wood or wood products that have been cut or shaped and include wet, air dried, and kiln dried wood products. Clean lumber does not include wood products that have been painted, pigment stained, or pressure treated by compounds such as chromate copper arsenate, pentachlorophenol, and creosote.

"Commercial and industrial solid waste incineration (CISWI) unit" means any combustion device that combusts commercial and industrial waste, as defined in this section. The boundaries of a CISWI unit are defined as, but not limited to, the commercial or industrial solid waste fuel feed system, grate system, flue gas system, and bottom ash. The

CISWI unit does not include air pollution control equipment or the stack. The CISWI unit boundary starts at the commercial and industrial solid waste hopper (if applicable) and extends through two areas:

1. The combustion unit flue gas system, which ends immediately after the last combustion chamber.
2. The combustion unit bottom ash system, which ends at the truck loading station or similar equipment that transfers the ash to final disposal. It includes all ash handling systems connected to the bottom ash handling system.

"Commercial and industrial waste" means solid waste combusted in an enclosed device using controlled flame combustion without energy recovery that is a distinct operating unit of any commercial or industrial facility (including field erected, modular, and custom built incineration units operating with starved or excess air), or solid waste combusted in an air curtain incinerator without energy recovery that is a distinct operating unit of any commercial or industrial facility.

"Contained gaseous material" means gases that are in a container when that container is combusted.

"Cyclonic barrel burner" means a combustion device for waste materials that is attached to a 55 gallon, open head drum. The device consists of a lid, which fits onto and encloses the drum, and a blower that forces combustion air into the drum in a cyclonic manner to enhance the mixing of waste material and air.

"Deviation" means any instance in which an affected source subject to this article, or an owner of such a source:

1. Fails to meet any requirement or obligation established by this article, including but not limited to any emission limitation, operating limit, or operator qualification and accessibility requirements;
2. Fails to meet any term or condition that is adopted to implement an applicable requirement in this article and that is included in the federal operating permit for any affected source required to obtain such a permit; or
3. Fails to meet any emission limitation, operating limit, or operator qualification and accessibility requirement in this article during startup, shutdown, or malfunction, regardless of whether such failure is permitted by this article.

"Dioxins/furans" means tetra through octachlorinated dibenzo-p-dioxins and dibenzofurans.

"Discard" means, for purposes of this article, to burn in an incineration unit without energy recovery.

"Drum reclamation unit" means a unit that burns residues out of drums (e.g., 55 gallon drums) so that the drums can be reused.

"Energy recovery" means the process of recovering thermal energy from combustion for useful purposes such as steam generation or process heating.

"Federal operating permit" means a permit issued under Article 1 (9VAC5-80-50 et seq.) or Article 3 (9VAC5-80-360 et seq.) of Part II of 9VAC5-Chapter 80.

"Fabric filter" means an add-on air pollution control device used to capture particulate matter by filtering gas streams through filter media (e.g., baghouse).

"Low level radioactive waste" means waste material which contains radioactive nuclides emitting primarily beta or gamma radiation, or both, in concentrations or quantities that exceed applicable federal or state standards for unrestricted release. Low level radioactive waste is not high level radioactive waste, spent nuclear fuel, or by product material as defined by the Atomic Energy Act of 1954 (42 USC § 2014(e)(2)).

"Malfunction" means any sudden, infrequent, and not reasonably preventable failure of air pollution control equipment, process equipment, or a process to operate in a normal or usual manner. Failures that are caused, in part, by poor maintenance or careless operation are not malfunctions.

"Modification" or "modified CISWI unit" means a CISWI unit that has been changed later than June 1, 2001, and that meets one of the following criteria:

1. The cumulative cost of the changes over the life of the unit exceeds 50% of the original cost of building and installing the CISWI unit (not including the cost of land) updated to current costs (current dollars). To determine what systems are within the boundary of the CISWI unit used to calculate these costs, see the definition of CISWI unit.

2. Any physical change in the CISWI unit or change in the method of operating it that increases the amount of any air pollutant emitted for which § 129 or § 111 of the Clean Air Act has established standards.

"Part reclamation unit" means a unit that burns coatings off parts (e.g., tools, equipment) so that the parts can be reconditioned and reused.

"Particulate matter" means total particulate matter emitted from CISWI units as measured by Reference Method 5 or 29.

"Pathological waste" means waste material consisting of only human or animal remains, anatomical parts, anatomical tissue, the bags and containers used to collect and transport the waste material, and animal bedding (if applicable).

"Rack reclamation unit" means a unit that burns the coatings off of racks that are used to hold small items for application of a coating. The unit burns the coating overspray off of the rack so the rack can be reused.

"Reconstruction" means the rebuilding of a CISWI unit that meets the following criteria:

1. The reconstruction begins on or after June 1, 2001, and
2. The cumulative cost of the construction over the life of the incineration unit exceeds 50% of the original cost of building and installing the CISWI unit (not including land)

updated to current costs (current dollars). To determine what systems are within the boundary of the CISWI unit used to calculate these costs, see the definition of CISWI unit.

"Refuse derived fuel" means a type of municipal solid waste produced by processing municipal solid waste through shredding and size classification. This includes all classes of refuse derived fuel, including (i) low density fluff refuse-derived fuel through densified refuse derived fuel and (ii) pelletized refuse derived fuel.

"Shutdown" means the period of time after all waste has been combusted in the primary chamber.

"Solid waste" means any garbage, refuse, sludge from a waste treatment plant, water supply treatment plant, or air pollution control facility and other discarded material, including solid, liquid, semisolid, or contained gaseous material resulting from industrial, commercial, mining, agricultural operations, and from community activities, but does not include solid or dissolved material in domestic sewage, or solid or dissolved materials in irrigation return flows or industrial discharges that are point sources subject to permits under § 402 of the Federal Water Pollution Control Act, as amended (33 USC § 1342), or source, special nuclear, or byproduct material as defined by the Atomic Energy Act of 1954, as amended (42 USC § 2014). For purposes of this article, solid waste does not include the waste burned in the units described in 9VAC5-40-6250-C.

"Standard conditions" means, when referring to units of measure, a temperature of 68 degrees Fahrenheit (20°C) and a pressure of 1 atmosphere (101.3 kilopascals).

"Startup period" means the period of time between the activation of the system and the first charge to the unit.

"Wet scrubber" means an add-on air pollution control device that utilizes an aqueous or alkaline scrubbing liquor to collect particulate matter (including nonvaporous metals and condensed organics), or to absorb and neutralize acid gases, or both.

"Wood waste" means untreated wood and untreated wood products, including tree stumps (whole or chipped), trees, tree limbs (whole or chipped), bark, sawdust, chips, scraps, slabs, millings, and shavings. Wood waste does not include:

1. Grass, grass clippings, bushes, shrubs, and clippings from bushes and shrubs from residential, commercial/retail, institutional, or industrial sources as part of maintaining yards or other private or public lands.
2. Construction, renovation, or demolition wastes.
3. Clean lumber.

9VAC5-40-6270. Standard for particulate matter Emission limits and emission standards.

No owner or other person shall cause or permit to be discharged into the atmosphere from any CISWI any particulate emissions in excess of 70 milligrams per dry

Regulations

~~standard cubic meter, measured at 7.0% oxygen, dry basis at standard conditions that allowed under 40 CFR 60.2670.~~

~~**9VAC5-40-6280. Standard for carbon monoxide. (Repealed.)**~~

~~No owner or other person shall cause or permit to be discharged into the atmosphere from any CISWI any carbon monoxide emissions in excess of 157 parts per million by dry volume, measured at 7.0% oxygen, dry basis at standard conditions.~~

~~**9VAC5-40-6290. Standard for dioxins/furans. (Repealed.)**~~

~~No owner or other person shall cause or permit to be discharged into the atmosphere from any CISWI any dioxin/furan emissions in excess of 0.41 nanograms per dry standard cubic meter (toxic equivalency basis), measured at 7.0% oxygen, dry basis at standard conditions.~~

~~**9VAC5-40-6300. Standard for hydrogen chloride. (Repealed.)**~~

~~No owner or other person shall cause or permit to be discharged into the atmosphere from any CISWI any hydrogen chloride emissions in excess of 62 parts per million by dry volume, measured at 7.0% oxygen, dry basis at standard conditions.~~

~~**9VAC5-40-6310. Standard for sulfur dioxide. (Repealed.)**~~

~~No owner or other person shall cause or permit to be discharged into the atmosphere from any CISWI any sulfur dioxide emissions in excess of 20 parts per million by dry volume, measured at 7.0% oxygen, dry basis at standard conditions.~~

~~**9VAC5-40-6320. Standard for nitrogen oxides. (Repealed.)**~~

~~No owner or other person shall cause or permit to be discharged into the atmosphere from any CISWI any nitrogen oxide emissions in excess of 388 parts per million by dry volume, measured at 7.0% oxygen, dry basis at standard conditions.~~

~~**9VAC5-40-6330. Standard for lead. (Repealed.)**~~

~~No owner or other person shall cause or permit to be discharged into the atmosphere from any CISWI any lead emissions in excess of 0.04 milligrams per dry standard cubic meter, measured at 7.0% oxygen, dry basis at standard conditions.~~

~~**9VAC5-40-6340. Standard for cadmium. (Repealed.)**~~

~~No owner or other person shall cause or permit to be discharged into the atmosphere from any CISWI any cadmium emissions in excess of 0.004 milligrams per dry standard cubic meter, measured at 7.0% oxygen, dry basis at standard conditions.~~

~~**9VAC5-40-6350. Standard for mercury. (Repealed.)**~~

~~No owner or other person shall cause or permit to be discharged into the atmosphere from any CISWI any mercury emissions in excess of 0.47 milligrams per dry standard cubic~~

~~meter, measured at 7.0% oxygen, dry basis at standard conditions.~~

~~**9VAC5-40-6370. Standard for fugitive dust/emissions.**~~

~~The provisions of Article 1 (9VAC5 40 60 et seq.) of 9VAC5 Chapter 40 (Emission Standards for Fugitive Dust/Emissions, Rule 4-1) apply.~~

~~A. The provisions of Article 1 (9VAC5-40-60 et seq.) of 9VAC5-40 (Emission Standards for Visible Emissions and Fugitive Dust/Emissions, Rule 4-1) apply, with the exception of 9VAC5-40-80 (Standard for visible emissions), 9VAC5-40-100 (Monitoring), 9VAC5-40-110 (Test methods and procedures), and 9VAC5-40-120 (Waivers).~~

~~B. No owner or other person shall cause or permit to be discharged into the atmosphere from any ash conveying system (including conveyor transfer points) any visible emissions for more than 5.0% of hourly observation period, measured at three, 1-hour observation periods.~~

~~**9VAC5-40-6380. Standard for odor.**~~

~~The provisions of Article 2 (9VAC5-40-130 et seq.) of 9VAC5 Chapter 40 9VAC5-40 (Emission Standards for Odor, Rule 4-2) apply.~~

~~**9VAC5-40-6390. Standard for toxic pollutants.**~~

~~The provisions of Article 4 (9VAC5-60-200 et seq.) of 9VAC5 Chapter 60 9VAC5-60 (Emission Standards for Toxic Pollutants, Rule 6-4) apply.~~

~~**9VAC5-40-6400. Operator training and qualification.**~~

~~A. No CISWI unit shall be operated unless a fully trained and qualified CISWI unit operator is accessible, whether at the facility or capable of being at the facility within one hour. The trained and qualified CISWI unit operator may operate the CISWI unit directly or be the direct supervisor of one or more other plant personnel who operate the unit. If all qualified CISWI unit operators are temporarily not accessible, the procedures in subsection J of this section shall be followed. The provisions of 40 CFR 60.2635 through 40 CFR 60.2665 apply.~~

~~B. Operator training and qualification shall be obtained through a program approved by the board or by completing the requirements included in subsection C of this section.~~

~~C. Training shall be obtained by completing an incinerator operator training course that includes, at a minimum, the following:~~

~~1. Training on the following subjects:~~

- ~~a. Environmental concerns, including types of emissions.~~
- ~~b. Basic combustion principles, including products of combustion.~~
- ~~c. Operation of the specific type of incinerator to be used by the operator, including proper startup, waste charging, and shutdown procedures.~~
- ~~d. Combustion controls and monitoring.~~

~~e. Operation of air pollution control equipment and factors affecting performance (if applicable).~~

~~f. Inspection and maintenance of the incinerator and air pollution control devices.~~

~~g. Actions to correct malfunctions or conditions that may lead to malfunction.~~

~~h. Bottom and fly ash characteristics and handling procedures.~~

~~i. Applicable federal, state, and local regulations, including Occupational Safety and Health Administration workplace standards.~~

~~j. Pollution prevention.~~

~~k. Waste management practices.~~

~~2. An examination designed and administered by the instructor.~~

~~3. Written material covering the training course topics that can serve as reference material following completion of the course.~~

~~D. The operator training course shall be completed by the later of the following dates:~~

~~1. One year after the baseline compliance date.~~

~~2. Six months after CISWI unit startup.~~

~~3. Six months after an employee assumes responsibility for operating the CISWI unit or assumes responsibility for supervising the operation of the CISWI unit.~~

~~E. Operator qualification shall be obtained by completing a training course that satisfies the criteria under subsection B of this section. Qualification is valid from the date on which the training course is completed and the operator successfully passes the examination required under subdivision C 2 of this section.~~

~~F. To maintain operator qualification, the operator shall complete an annual review or refresher course covering, at a minimum, the following topics:~~

~~1. Update of regulations.~~

~~2. Incinerator operation, including startup and shutdown procedures, waste charging, and ash handling.~~

~~3. Inspection and maintenance.~~

~~4. Responses to malfunctions or conditions that may lead to malfunction.~~

~~5. Discussion of operating problems encountered by attendees.~~

~~G. Lapsed operator qualification shall be renewed when the operator:~~

~~1. For a lapse of less than three years, completes a standard annual refresher course described in subsection F of this section, or~~

~~2. For a lapse of three years or more, repeats the initial qualification requirements in subsection E of this section.~~

~~H. Site specific documentation shall be available at the facility and readily accessible for all CISWI unit operators that addresses the topics described in subdivisions H 1 through 10 of this subsection. The owner shall maintain this information and the training records required by subdivision I 3 of this section in a manner that they can be readily accessed and are suitable for inspection upon request.~~

~~1. Summary of the applicable standards under this article.~~

~~2. Procedures for receiving, handling, and charging waste.~~

~~3. Incinerator startup, shutdown, and malfunction procedures.~~

~~4. Procedures for maintaining proper combustion air supply levels.~~

~~5. Procedures for operating the incinerator and associated air pollution control systems within the standards established under this article.~~

~~6. Monitoring procedures for demonstrating compliance with the incinerator operating limits.~~

~~7. Reporting and recordkeeping procedures.~~

~~8. The waste management plan required under 9VAC5-40-6410.~~

~~9. Procedures for handling ash.~~

~~10. A list of the wastes burned during the emission test.~~

~~I. A program for reviewing the following information shall be established for each incinerator operator:~~

~~1. The initial review of the information listed in subsection H of this section shall be conducted by the later of the following dates:~~

~~a. One year after the baseline compliance date.~~

~~b. Six months after CISWI unit startup.~~

~~c. Six months after being assigned to operate the CISWI unit.~~

~~2. Subsequent annual reviews of the information listed in subsection H of this section shall be conducted no later than 12 months following the previous review.~~

~~3. The following information shall be maintained:~~

~~a. Records showing the names of CISWI unit operators who have completed review of the information in subsection H of this section as required by this subsection, including the date of the initial review and all subsequent annual reviews.~~

~~b. Records showing the names of the CISWI operators who have completed the operator training requirements under subsection C of this section, met the criteria for qualification under subsection E of this section, and maintained or renewed their qualification under subsection F or G of this section. Records shall include documentation of training, the dates of the initial refresher training, and the dates of their qualification and all subsequent renewals of such qualifications.~~

Regulations

~~c. For each qualified operator, the telephone or pager number at which they can be reached during operating hours.~~

~~J. If all qualified operators are temporarily not accessible (i.e., not at the facility and not able to be at the facility within one hour), one of the following procedures shall be followed:~~

~~1. When all qualified operators are not accessible for more than 8 hours, but less than two weeks, the CISWI unit may be operated by other plant personnel familiar with the operation of the CISWI unit who have completed a review of the information specified in subsection H of this section within the past 12 months. The period when all qualified operators were not accessible shall be recorded, and this deviation shall be included in the annual report as specified in 9VAC5-40-6480 G.~~

~~2. When all qualified operators are not accessible for two weeks or more, the owner shall perform the following:~~

~~a. Notify the board of this deviation in writing within 10 days, including the cause of the deviation, what is being done to ensure that a qualified operator is accessible, and the anticipated date when a qualified operator will be accessible.~~

~~b. Submit a status report to the board every 4 weeks outlining what is being done to ensure that a qualified operator is accessible, the anticipated date when a qualified operator will be accessible, and a request for approval from the board to continue operation of the CISWI unit. The first status report shall be submitted 4 weeks after the board has been notified of the deviation under subdivision 2 a of this subsection. If the board disapproves the request to continue operation of the CISWI unit, the CISWI unit may continue operation for 90 days. After 90 days, the CISWI unit shall cease operation. Operation of the unit may resume if the following requirements are met:~~

~~(1) A qualified operator is accessible as required under subsection A of this section.~~

~~(2) The board is notified that a qualified operator is accessible and that operation is resuming.~~

~~K. The requirements of subsection B of this section with regard to obtaining operator training qualifications through a program approved by the board may be met by obtaining a license from the Board for Waste Management Facility Operators. All training and licensing shall be conducted in accordance with Chapter 22.1 (§ 54.1-2209 et seq.) of Title 54.1 of the Code of Virginia and with 18VAC155 Chapter 20.~~

~~L. No owner of an affected facility shall allow the facility to be operated at any time unless a person is on duty who is responsible for the proper operation of the facility and has a license from the Board for Waste Management Facility Operators in the correct classification. No provision of this article shall relieve any owner from the responsibility to comply in all respects with the requirements of Chapter 22.1~~

~~(§ 54.1-2209 et seq.) of Title 54.1 of the Code of Virginia and with 18VAC155 Chapter 20.~~

9VAC5-40-6410. Waste management plan.

~~A. The owner of an affected facility shall prepare a written waste management plan that identifies both the feasibility and the methods used to reduce or separate certain components of solid waste from the waste stream in order to reduce or eliminate toxic emissions from incinerated waste in accordance with the provisions of 40 CFR 60.2620 through 40 CFR 60.2630.~~

~~B. The waste management plan shall be submitted no later than six months after the baseline compliance date.~~

~~C. The waste management plan shall include consideration of the reduction or separation of waste stream elements such as paper, cardboard, plastics, glass, batteries, or metals; or the use of recyclable materials. The plan shall identify any additional waste management measures; and the owner of an affected facility shall implement those measures considered practical and feasible, based on the effectiveness of waste management measures already in place, the costs of additional measures, the emissions reductions expected to be achieved, and any other environmental or energy impacts they might have.~~

9VAC5-40-6420. Compliance schedule.

~~A. The owner of a CISWI unit planning to continue operation and achieve compliance with this article by the date one year after the baseline compliance date shall complete the following: All CISWI units regardless of category shall achieve final compliance as expeditiously as practicable but not later than February 7, 2018.~~

~~1. Comply with the operator training and qualification requirements and inspection requirements, if applicable, of 9VAC5-40-6400 by the date one year after the baseline compliance date.~~

~~2. Submit a waste management plan no later than six months after the baseline compliance date.~~

~~3. Achieve final compliance by the date one year after the baseline compliance date. The final compliance increment of progress shall be achieved by incorporation of all process changes and completion of retrofit construction of control devices, as specified in the final control plan, in order that the affected unit brought online operates all necessary process changes and air pollution control devices as designed.~~

~~4. Conduct the initial emission test no later than 90 days after the final compliance date specified in subdivision 3 of this subsection.~~

~~5. Submit an initial report, including the results of the initial emission test, no later than 60 days following the initial emission test as required by 9VAC5-40-6480 E.~~

~~B. The owner of a CISWI unit planning to continue operation and achieve compliance with this article after the~~

date one year after the baseline compliance date and before the date two years after the baseline compliance date shall (i) petition for an extension of the final compliance date specified in subdivision A 3 of this section by meeting the requirements of 9VAC5 40 6421, and shall have been granted the extension by the board; and (ii) meet the increments of progress in subsection C of this section. The final compliance increment of progress shall be achieved by completion of the following: The owner shall submit a final control plan no later than February 7, 2015.

1. Comply with the operator training and qualification requirements and inspection requirements, if applicable, of 9VAC6 40 6400 by the date one year after the baseline compliance date.
2. Submit a waste management plan no later than six months after the baseline compliance date.
3. Achieve final compliance by the date two years after the baseline compliance date. The final compliance increment of progress shall be achieved by incorporation of all process changes and completion of retrofit construction of control devices, as specified in the final control plan, in order that the affected unit brought online operates all necessary process changes and air pollution control devices as designed.
4. Conduct the initial emission test no later than 90 days after the final compliance date specified in subdivision 3 of this subsection.
5. Submit an initial report, including the result of the initial emission test, no later than 60 days following the initial emission test as required by 9VAC5 40 6480 E.

C. ~~The owner of a CISWI unit planning to achieve compliance later than one year after the baseline compliance date shall meet the following increments of progress: The provisions of 40 CFR 60.2575 through 40 CFR 60.2615 apply.~~

1. Submit and maintain a final control plan by the date six months after the baseline compliance date.
2. Achieve final compliance by the date two years after the baseline compliance date.

D. ~~The owner shall notify the board as increments of progress are achieved. Notification of achievement of increments of progress shall include the following:~~

1. Notification that the increment of progress has been achieved.
2. Any items required to be submitted with each increment of progress.
3. Signature of the owner of the CISWI unit.

E. ~~Notifications for achieving increments of progress shall be postmarked no later than 10 business days after the compliance date for the increment.~~

F. ~~If an increment of progress is not met, the owner of the affected source shall submit a notification to the board~~

~~postmarked within 10 business days after the date for that increment of progress. The owner shall continue to submit reports each subsequent calendar month until the increment of progress is met.~~

G. ~~The control plan increment of progress shall meet the following requirements:~~

1. ~~Submittal of the final control plan, which shall include the following:~~
 - a. ~~A description of the devices for air pollution control and process changes that will be used to comply with the emission limitations and other requirements of this article;~~
 - b. ~~The types of waste to be burned;~~
 - c. ~~The maximum design waste burning capacity;~~
 - d. ~~The anticipated maximum charge rate; and~~
 - e. ~~If applicable, the petition for site specific operating limits under 9VAC5 40 6430 D.~~
2. ~~Maintenance of a copy of the final control plan onsite.~~

9VAC5-40-6421. Compliance schedule extension. (Repealed.)

~~The owner of a CISWI unit planning to continue operation and achieve compliance with this article after the date one year after the baseline compliance date and before the date two years after the baseline compliance date shall petition the board for an extension using the following procedures:~~

1. ~~The request for an extension shall be submitted to the board on or before the date two months after the baseline compliance date.~~
2. ~~The request shall include documentation of the analyses undertaken to support the need for an extension, including an explanation of why the final compliance date specified in 9VAC5 40 6420 A 3 cannot be met, and why the requested extension date is needed to provide sufficient time for design, fabrication, and installation of the emissions control systems necessary to meet the requirements of this article. No request will be granted based upon the avoidance of costs.~~

9VAC5-40-6422. Shutdown and restart. (Repealed.)

~~A. The owner of a CISWI unit planning to permanently shut down rather than comply with the complete set of requirements in this article shall complete the following:~~

1. ~~If shutdown is planned to be completed by the date one year after the baseline compliance date, then shutdown must occur no later than the date one year after the baseline compliance date. The federal operating permit requirements of 9VAC5 40 6250 F shall be met regardless of when shutdown occurs.~~
2. ~~If shutdown is planned but cannot be achieved by the date one year after the baseline compliance date, the owner of a CISWI unit shall petition the board for and be granted an extension using the following procedures:~~

Regulations

a. Submit the request for an extension to the board by the date two months after the baseline compliance date. The request shall include the following:

(1) Documentation of the analyses undertaken to support the need for an extension, including an explanation of why the requested extension date is sufficient for shutdown while the date one year after the baseline compliance date is not sufficient. No request will be granted based upon the avoidance of costs. Documentation shall include an evaluation of the option to transport waste offsite to a commercial or municipal waste treatment or disposal facility or both on a temporary or permanent basis.

(2) Documentation of incremental steps of progress, including dates for completing the increments of progress, that will be taken toward shutdown.

b. Shutdown shall occur no later than the date two years after the baseline compliance date.

3. Compliance with the operator training and qualification requirements and inspection requirements, if applicable, of 9VAC5 40 6400 shall be achieved by the date one year after the baseline compliance date.

4. A legally binding closure agreement shall be submitted to the board by the date six months after the baseline compliance date. The closure agreement shall specify the date by which operation will cease. The closure date shall be no later than the date two years after the baseline compliance date.

5. The federal operating permit requirements of 9VAC5-40-6250 F shall be met regardless of when shutdown occurs.

B. If the CISWI unit is temporarily shut down and restarted for the purpose of continuing operation, the following requirements shall be met. The federal operating permit requirements of 9VAC5 40 6250 F shall be met at the time the unit is restarted.

1. If operation is planned to continue and compliance is planned to be achieved by the date one year after the baseline compliance date, the requirements of 9VAC5 40-6420 A shall apply.

2. If operation is planned to continue and compliance is planned to be achieved on or before the date two years after the baseline compliance date, the requirements of 9VAC5 40 6420 B shall be met. The owner of a CISWI unit shall have first requested an extension from the initial compliance date by following the requirements of 9VAC5-40-6421, and shall have been granted the extension by the board.

3. If the unit is restarted after the date one year after the baseline compliance date and resumes operation, but the owner has not previously requested an extension by meeting the requirements of 9VAC5 40 6421, the owner shall complete the requirements of 9VAC5 40 6420 A at

the time the unit is restarted. Upon restarting the unit, the owner shall have incorporated all process changes and completed retrofit construction of control devices in order that the affected unit brought online operates all necessary process changes and air pollution control devices as designed.

C. For purposes of this section, the term "shutdown" shall have the meaning specified in 9VAC5 Chapter 10.

9VAC5-40-6430. Operating limits.

A. The owner of a facility using wet scrubbers shall meet operating limits as established in subdivisions 1 and 2 of this subsection. No owner or other person shall operate any CISWI unit in a manner that does not comply with the provisions of 40 CFR 60.2675 through 40 CFR 60.2680.

1. Operating limits for operating parameters shall be in accordance with Table 4-45A.

TABLE 4-45A
OPERATING LIMITS FOR WET SCRUBBERS

Operating parameters	Operating limits	Minimum frequencies		
		Data measurement	Data recording	Averaging time
Charge rate	Maximum charge rate	Continuous	Every hour	Daily (batch units); 3-hour rolling (continuous and intermittent units) ^a
Pressure drop across the wet scrubber or amperage to wet scrubber	Minimum pressure drop or amperage	Continuous	Every 15 minutes	3-hour rolling ^a
Scrubber liquor flow rate	Minimum flow rate	Continuous	Every 15 minutes	3-hour rolling ^a
Scrubber liquor pH	Minimum pH	Continuous	Every 15 minutes	3-hour rolling ^a

^aCalculated each hour as the average of the previous three operating hours.

2. Operating limits for wet scrubbers shall be established during the initial emission test as follows:

a. Maximum charge rate shall be calculated using one of the following procedures:

(1) For continuous and intermittent units, the maximum charge rate is 110% of the average charge rate measured during the most recent emission test demonstrating compliance with all applicable emission limitations.

(2) For batch units, the maximum charge rate is 110% of the daily charge rate measured during the most recent

~~emission test demonstrating compliance with all applicable emission limitations.~~

~~b. Minimum pressure drop across the wet scrubber, which is calculated as 90% of the average pressure drop across the wet scrubber measured during the most recent emission test demonstrating compliance with the particulate matter emission limitations; or minimum amperage to the wet scrubber, which is calculated as 90% of the average amperage to the wet scrubber measured during the most recent emission test demonstrating compliance with the particulate matter emission limitations.~~

~~e. Minimum scrubber liquor flow rate, which is calculated as 90% of the average liquor flow rate at the inlet to the wet scrubber measured during the most recent emission test demonstrating compliance with all applicable emission limitations.~~

~~d. Minimum scrubber liquor pH, which is calculated as 90% of the average liquor pH at the inlet to the wet scrubber measured during the most recent emission test demonstrating compliance with the hydrogen chloride emission limitation.~~

~~B. Operating limits established during the initial emission test shall be met on the date the initial emission test is required or completed, whichever is earlier.~~

~~C. If a fabric filter is used to comply with the emission limitations, each fabric filter system shall be operated such that the bag leak detection system alarm does not sound more than 5.0% of the operating time during a six month period. In calculating this operating time percentage, if inspection of the fabric filter demonstrates that no corrective action is required, no alarm time is counted. If corrective action is required, each alarm shall be counted as a minimum of one hour. If longer than one hour to initiate corrective action transpires, the alarm time shall be counted as the actual amount of time taken to initiate corrective action.~~

~~D. If an air pollution control device other than a wet scrubber is used, or if emissions are controlled in some other manner, the owner shall petition the board for specific operating limits to be established during the initial emission test and continuously monitored thereafter. The initial emission test shall not be conducted until after the petition has been approved by the board. The petition shall include the following:~~

- ~~1. Identification of the specific parameters proposed to be used as additional operating limits.~~
- ~~2. A discussion of the relationship between these parameters and emissions of regulated pollutants, identifying how emissions of regulated pollutants change with changes in these parameters, and how limits on these parameters will limit emissions of regulated pollutants.~~

~~3. A discussion of how the upper or lower values, or both, for these parameters, which will establish the operating limits on these parameters, will be established.~~

~~4. A discussion identifying the methods to be used to measure and the instruments to be used to monitor these parameters, and the relative accuracy and precision of these methods and instruments.~~

~~5. A discussion identifying the frequency and methods for recalibrating the instruments used for monitoring these parameters.~~

9VAC5-40-6440. Facility and control equipment maintenance or malfunction.

~~A. The provisions of 9VAC5-20-180 (Facility and control equipment maintenance or malfunction) apply With regard to the emission standards set forth in 9VAC5-40-6360 A, 9VAC5-40-6370 A, 9VAC5-40-6380, and 9VAC5-40-6390, the provisions of 9VAC5-20-180 (Facility and control equipment maintenance or malfunction) apply.~~

~~B. The provisions of 9VAC5-20-180 A, B, C, D, H, and I apply With regard to the emission limits in 9VAC5-40-6270 through 9VAC5-40-6360, 9VAC5-40-6360 B, and 9VAC5-40-6370 B, the following provisions apply:~~

~~1. 9VAC5-20-180 with the exception of subsections E, F, and G; and~~

~~2. 40 CFR 60.2685.~~

~~C. The emission limitations and operating limits apply at all times except during CISWI unit startups, shutdowns, or malfunctions. Each malfunction shall last no longer than three hours. This subsection shall not apply to the emission standards set forth in 9VAC5-40-6370, 9VAC5-40-6380, and 9VAC5-40-6390.~~

9VAC5-40-6450. Test methods and procedures Performance testing.

~~A. The provisions governing test methods and procedures shall be as follows:~~

~~1. A. With regard to the emissions standards in 9VAC5-40-6360 A, 9VAC5-40-6370 A, 9VAC5-40-6380, and 9VAC5-40-6390, the provisions of 9VAC5-40-30 (Emission testing) apply.~~

~~2. B. With regard to the emission limits in 9VAC5-40-6270 through 9VAC5-40-6360, 9VAC5-40-6360 B, and 9VAC5-40-6370 B, the following provisions apply:~~

~~a. 1. 9VAC5-40-30 D and G;~~

~~b. 2. 40 CFR 60.8, with the exception of paragraph (a); and~~

~~e. Subsections B through H of this section 3. 40 CFR 60.2690 through 40 CFR 60.2695.~~

~~B. All emission tests shall consist of a minimum of three test runs conducted under conditions representative of normal operations.~~

Regulations

C. The owner shall document that the waste burned during the emission test is representative of the waste burned under normal operating conditions by maintaining a log of the quantity of waste burned (as required in 9VAC5-40-6480 B-2 a) and the types of waste burned during the emission test.

D. All emission tests shall be conducted using the following minimum run durations and reference methods:

1. For particulate matter: 3 run average (one hour minimum sample time per run), Reference Method 5 or 29.
2. For carbon monoxide: 3 run average (one hour minimum sample time per run), Reference Method 10, 10A, or 10B.
3. For dioxins/furans: 3 run average (one hour minimum sample time per run), Reference Method 23.
4. For hydrogen chloride: 3 run average (one hour minimum sample time per run), Reference Method 26A.
5. For sulfur dioxide: 3 run average (one hour minimum sample time per run), Reference Method 6 or 6c.
6. For nitrogen oxides: 3 run average (one hour minimum sample time per run), Reference Methods 7, 7A, 7C, 7D, or 7E.
7. For lead: 3 run average (one hour minimum sample time per run), Reference Method 29.
8. For cadmium: 3 run average (one hour minimum sample time per run), Reference Method 29.
9. For mercury: 3 run average (one hour minimum sample time per run), Reference Method 29.
10. For visible emissions: six minute average, Reference Method 9.

E. Reference Method 1 shall be used to select the sampling location and number of traverse points.

F. Reference Method 3A or 3B shall be used for gas composition analysis, including measurement of oxygen concentration. Reference Method 3A or 3B shall be used simultaneously with each method.

G. All pollutant concentrations, except for opacity, shall be adjusted to 7.0% oxygen using the following equation:

$$C_{adj} = C_{meas} (20.9\% - 7) / (20.9\% - \% O_2)$$

where:

C_{adj} = pollutant concentration adjusted to 7.0% oxygen;

C_{meas} = pollutant concentration measured on a dry basis;

$(20.9 - 7)$ = 20.9% oxygen - 7.0% oxygen (defined oxygen correction basis);

20.9 = oxygen concentration in air, percent; and

$\% O_2$ = oxygen concentration measured on a dry basis, percent.

H. The owner of an affected facility shall determine the dioxins/furans toxic equivalency as follows:

1. Measure the concentration of each dioxin/furan tetra-through-octa congener emitted using EPA Method 23.

2. For each dioxin/furan congener measured in accordance with subdivision 1 of this subsection, multiply the congener concentration by its corresponding toxic equivalency factor specified in Table 4-45B of this article.

TABLE 4-45B.
TOXIC EQUIVALENCY FACTORS

Dioxin/furan congener	Toxic equivalency factor
2,3,7,8 tetrachlorinated dibenzo-p-dioxin	1
1,2,3,7,8 pentachlorinated dibenzo-p-dioxin	0.5
1,2,3,4,7,8 hexachlorinated dibenzo-p-dioxin	0.1
1,2,3,7,8,9 hexachlorinated dibenzo-p-dioxin	0.1
1,2,3,6,7,8 hexachlorinated dibenzo-p-dioxin	0.1
1,2,3,4,6,7,8 heptachlorinated dibenzo-p-dioxin	0.01
Octachlorinated dibenzo-p-dioxin	0.001
2,3,7,8 tetrachlorinated dibenzofuran	0.1
2,3,4,7,8 pentachlorinated dibenzofuran	0.5
1,2,3,7,8 pentachlorinated dibenzofuran	0.05
1,2,3,4,7,8 hexachlorinated dibenzofuran	0.1
1,2,3,6,7,8 hexachlorinated dibenzofuran	0.1
1,2,3,7,8,9 hexachlorinated dibenzofuran	0.1
2,3,4,6,7,8 hexachlorinated dibenzofuran	0.1
1,2,3,4,6,7,8 heptachlorinated dibenzofuran	0.01
1,2,3,4,7,8,9 heptachlorinated dibenzofuran	0.01
Octachlorinated dibenzofuran	0.001

3. Sum the products calculated in accordance with subdivision 2 of this subsection to obtain the total

concentration of dioxins/furans emitted in terms of toxic equivalency.

9VAC5-40-6460. Compliance

A. The provisions governing compliance shall be as follows:

~~1.~~ With regard to the emissions standards in 9VAC5-40-6360 ~~A.~~ 9VAC5-40-6370 ~~A.~~ 9VAC5-40-6380, and 9VAC5-40-6390, the provisions of 9VAC5-40-20 (Compliance) apply.

~~2.~~ B. With regard to the emission limits in 9VAC5-40-6270 through 9VAC5-40-6360, 9VAC5-40-6360 B. and 9VAC5-40-6370 B., the following provisions apply:

a. 1. 9VAC5-40-20 B, C, D, and E;

b. 2. 40 CFR 60.11; and

e. Subsections B and C of this section 3. 40 CFR 60.2700 through 40 CFR 60.2725.

~~B.~~ The owner of an affected facility shall conduct an initial emission test to determine compliance with the emission limitations in 9VAC5-40-6270 through 9VAC5-40-6360 and to establish operating limits using the procedures in 9VAC5-40-6430. The initial emission test shall be conducted using the reference methods and procedures in 9VAC5-40-6450, and shall be conducted no later than 90 days after the final compliance date specified in 9VAC5-40-6420 A or B, as applicable.

~~C.~~ The owner of an affected facility shall conduct an annual emission test for particulate matter, hydrogen chloride, and opacity for each CISWI unit to determine compliance with the emission limitations under 9VAC5-40-6270 through 9VAC5-40-6360 as follows:

~~1.~~ The annual emission test shall be conducted using the test methods and procedures in 9VAC5-40-6450.

~~2.~~ The operating limits specified in 9VAC5-40-6430 shall be continuously monitored. Operation above the established maximum or below the established minimum operating limits constitutes a deviation from the established operating limits. Three hour rolling average values shall be used to determine compliance (except for baghouse leak detection system alarms) unless a different averaging period is established under 9VAC5-40-6430 D. Operating limits do not apply during emission tests.

~~3.~~ Only the same types of waste used to establish operating limits shall be burned during the emission test.

~~4.~~ Annual emission tests for particulate matter, hydrogen chloride, and opacity shall commence within 12 months following the initial emission test. Subsequent annual emission tests shall be conducted within 12 months following the previous one.

~~5.~~ The owner of an affected facility may conduct emission testing less often if the unit has test data for at least three years, and all emission tests for the pollutant (particulate matter, hydrogen chloride, or opacity) over three consecutive years show that the unit complies with the emission limitation. In this case, no emission test is

required for that pollutant for the next two years. The owner shall conduct an emission test during the third year and no more than 36 months following the previous emission test.

~~6.~~ If the CISWI unit continues to meet the emission limitation for particulate matter, hydrogen chloride, or opacity, the owner may conduct emission tests for these pollutants every third year, but each test shall be within 36 months of the previous test.

~~7.~~ If an emission test shows a deviation from an emission limitation for particulate matter, hydrogen chloride, or opacity, the owner shall conduct annual emission tests for that pollutant until all emission tests over a three year period show compliance.

~~8.~~ A repeat emission test may be conducted at any time to establish new values for the operating limits. The board may request a repeat emission test at any time. The emission test shall be repeated if the feed stream is different than the feed streams used during any emission test used to demonstrate compliance.

9VAC5-40-6470. Monitoring.

A. The provisions governing monitoring shall be as follows:

~~1.~~ With regard to the emissions standards in 9VAC5-40-6360 ~~A.~~ 9VAC5-40-6370 ~~A.~~ 9VAC5-40-6380, and 9VAC5-40-6390, the provisions of 9VAC5-40-40 (Monitoring) apply.

~~2.~~ B. With regard to the emission limits in 9VAC5-40-6270 through 9VAC5-40-6360, 9VAC5-40-6360 B. and 9VAC5-40-6370 B., the following provisions apply:

a. 1. 9VAC5-40-40 A and F;

b. 2. 40 CFR 60.13; and

e. Subsections B through F of this section 3. 40 CFR 60.2730 through 40 CFR 60.2735.

~~B.~~ The owner of an affected facility using a wet scrubber to comply with the emission limitations under 9VAC5-40-6270 through 9VAC5-40-6360 shall install, calibrate (to manufacturers' specifications), maintain, and operate devices (or establish methods) for monitoring the value of the operating parameters used to determine compliance with the operating limits listed in Table 4-45A. These devices (or methods) shall measure and record the values for these operating parameters at the frequencies indicated in Table 4-45A at all times except as specified in subsection E of this section.

~~C.~~ The owner of an affected facility using a fabric filter to comply with the requirements of this article shall install, calibrate, maintain, and continuously operate a bag leak detection system as follows:

~~1.~~ A bag leak detection system shall be installed and operated for each exhaust stack of the fabric filter.

~~2.~~ Each bag leak detection system shall be installed, operated, calibrated, and maintained in a manner consistent

Regulations

~~with the manufacturers' written specifications and recommendations.~~

~~3. The bag leak detection system shall be certified by the manufacturer to be capable of detecting particulate matter emissions at concentrations of 10 milligrams per actual cubic meter or less.~~

~~4. The bag leak detection system sensor shall provide output of relative or absolute particulate matter loadings.~~

~~5. The bag leak detection system shall be equipped with a device to continuously record the output signal from the sensor.~~

~~6. The bag leak detection system shall be equipped with an alarm system that sounds automatically when an increase in relative particulate matter emissions over a preset level is detected. The alarm shall be located where it is easily heard by plant operating personnel.~~

~~7. For positive pressure fabric filter systems, a bag leak detection system shall be installed in each baghouse compartment or cell. For negative pressure or induced air fabric filters, the bag leak detector shall be installed downstream of the fabric filter.~~

~~8. Where multiple detectors are required, the system's instrumentation and alarm may be shared among detectors.~~

~~D. The owner of an affected facility using something other than a wet scrubber to comply with the emission limitations under 9VAC5-40-6270 through 9VAC5-40-6260 shall install, calibrate (to the manufacturers' specifications), maintain, and operate the equipment necessary to monitor compliance with the site specific operating limits established using the procedures in 9VAC5-40-6430 D.~~

~~E. Except for monitoring malfunctions, associated repairs, and required quality assurance or quality control activities (including, as applicable, calibration checks and required zero and span adjustments of the monitoring system), the owner of an affected facility shall conduct all monitoring at all times the CISWI unit is operating.~~

~~F. Data recorded during monitoring malfunctions, associated repairs, and required quality assurance or quality control activities for meeting the requirements of this article, including data averages and calculations, shall not be used. All the data collected during all other periods shall be used in assessing compliance with the operating limits.~~

9VAC5-40-6480. Recordkeeping and reporting.

~~A. The provisions governing recordkeeping and reporting shall be as follows:~~

~~1. A. With regard to the emissions standards in 9VAC5-40-6360 A, 9VAC5-40-6370 A, 9VAC5-40-6380, and 9VAC5-40-6390, the provisions of 9VAC5-40-50 (Notification, records and reporting) apply.~~

~~2. B. With regard to the emission limits in 9VAC5-40-6270 through 9VAC5-40-6360, 9VAC5-40-6260 B, and 9VAC5-40-6370 B, the following provisions apply:~~

~~a. 1. 9VAC5-40-50 F and H;_i~~

~~b. 2. 40 CFR 60.7;_i and~~

~~c. Subsections B through J of this section 3. 40 CFR 60.2740 through 40 CFR 60.2800.~~

~~B. The following records, as applicable, shall be maintained for a period of at least five years:~~

~~1. Calendar date of each record.~~

~~2. Records of the following data:~~

~~a. The CISWI unit charge dates, times, weights, and hourly charge rates.~~

~~b. Liquor flow rate to the wet scrubber inlet every 15 minutes of operation, as applicable.~~

~~c. Pressure drop across the wet scrubber system every 15 minutes of operation or amperage to the wet scrubber every 15 minutes of operation, as applicable.~~

~~d. Liquor pH as introduced to the wet scrubber every 15 minutes of operation, as applicable.~~

~~e. For affected CISWI units that establish operating limits for controls other than wet scrubbers under 9VAC5-40-6430 D, the owner shall maintain data collected for all operating parameters used to determine compliance with the operating limits.~~

~~f. If a fabric filter is used to comply with the emission limitations, the owner shall record the date, time, and duration of each alarm and the time corrective action was initiated and completed, and a brief description of the cause of the alarm and the corrective action taken. The owner shall also record the percent of operating time during each six month period that the alarm sounds, calculated as specified in 9VAC5-40-6430 C.~~

~~3. Identification of calendar dates and times for which monitoring systems used to monitor operating limits were inoperative, inactive, malfunctioning, or out of control (except for downtime associated with zero and span and other routine calibration checks). Identify the operating parameters not measured, the duration, reasons for not obtaining the data, and a description of corrective actions taken.~~

~~4. Identification of calendar dates, times, and durations of malfunctions, and a description of the malfunction and the corrective action taken.~~

~~5. Identification of calendar dates and times for which data show a deviation from the operating limits in Table 4-45A or a deviation from other operating limits established under 9VAC5-40-6430 D with a description of the deviations, reasons for such deviations, and a description of corrective actions taken.~~

~~6. The results of the initial, annual, and any subsequent emission tests conducted to determine compliance with the emission limits and to establish operating limits, as applicable. Retain a copy of the complete emission test report including calculations.~~

7. Records showing the names of CISWI unit operators who have completed review of the information in 9VAC5-40-6400 H as required by 9VAC5-40-6400 I, including the date of the initial review and all subsequent annual reviews.

8. Records showing the names of the CISWI operators who have completed the operator training requirements under 9VAC5-40-6400 A, met the criteria for qualification under 9VAC5-40-6400 E, and maintained or renewed their qualification under 9VAC5-40-6400 F or G. Records shall include documentation of training, the dates of the initial and refresher training, and the dates of their qualification and all subsequent renewals of such qualifications.

9. For each qualified operator, the telephone or pager number at which they can be reached during operating hours.

10. Records of calibration of any monitoring devices as required under 9VAC5-40-6470 A through C.

11. Equipment vendor specifications and related operation and maintenance requirements for the incinerator, emission controls, and monitoring equipment.

12. The information listed in 9VAC5-40-6400 H.

13. On a daily basis, a log of the quantity of waste burned and the types of waste burned.

C. All records shall be available onsite in either paper copy or computer readable format that can be printed upon request, unless an alternative format is approved by the board.

D. The owner of an affected facility shall submit the waste management plan no later than the date specified in 9VAC5-40-6410 B.

E. The information specified in this subsection shall be submitted no later than 60 days following the initial emission test. All reports shall be signed by the facilities manager:

1. The complete emission test report for the initial emission test results obtained under 9VAC5-40-6460 B, as applicable.

2. The values for the site specific operating limits established in 9VAC5-40-6430.

3. If a fabric filter is being used to comply with the emission limitations, documentation that a bag leak detection system has been installed and is being operated, calibrated, and maintained as required by 9VAC5-40-6470 C.

F. An annual report shall be submitted no later than 12 months following the submission of the information in subsection E of this section. Subsequent reports shall be submitted no more than 12 months following the previous report. If the unit is subject to permitting requirements under the federal operating permit program, the permit may require submittal of these reports more frequently.

G. The annual report required under subsection F of this section shall include the items listed in this subsection. If a

deviation from the operating limits or the emission limitations occurs, deviation reports shall also be submitted as specified in 9VAC5-40-6480 H.

1. Company name and address.

2. Statement by a responsible official, with that official's name, title, and signature, certifying the accuracy of the content of the report.

3. Date of report and beginning and ending dates of the reporting period.

4. The values for the operating limits established pursuant to 9VAC5-40-6430.

5. If no deviation from any applicable emission limitation or operating limit has been reported, a statement that there was no deviation from the emission limitations or operating limits during the reporting period, and that no monitoring system used to determine compliance with the operating limits was inoperative, inactive, malfunctioning or out of control.

6. The highest recorded three hour average and the lowest recorded three hour average, as applicable, for each operating parameter recorded for the calendar year being reported.

7. Information recorded under subdivisions B 2 f and B 3 through 5 of this section for the calendar year being reported.

8. If an emission test was conducted during the reporting period, the results of that test.

9. If the requirements of 9VAC5-40-6460 C 5 or 6 were met, and no emission test was conducted during the reporting period, a statement that the facility met the requirements of 9VAC5-40-6460 C 5 or 6, and, therefore, no emission test during the reporting period was required.

10. Documentation of periods when all qualified CISWI unit operators were unavailable for more than eight hours, but less than two weeks.

H. Deviation reports shall be submitted in accordance with the following:

1. A deviation report shall be submitted if (i) any recorded three hour average parameter level is above the maximum operating limit or below the minimum operating limit established under this article, (ii) the bag leak detection system alarm sounds for more than 5.0% of the operating time for the six month reporting period, or (iii) an emission test was conducted that deviated from any emission limitation.

2. The deviation report shall be submitted by August 1 of that year for data collected during the first half of the calendar year (January 1 to June 30), and by February 1 of the following year for data collected during the second half of the calendar year (July 1 to December 31).

3. For any pollutant or parameter that deviated from the emission limitations or operating limits specified in this

Regulations

article, the following items shall be included in the deviation report:

- a. ~~The calendar dates and times the unit deviated from the emission limitations or operating limit requirements.~~
- b. ~~The averaged and recorded data for those dates.~~
- c. ~~Duration and causes of each deviation from the emission limitations or operating limits, and corrective actions taken.~~
- d. ~~A copy of the operating limit monitoring data during each deviation and any emission test report that documents the emission levels.~~
- e. ~~The dates, times, number, duration, and causes for monitoring downtime incidents other than downtime associated with zero, span, and other routine calibration checks.~~
- f. ~~Whether each deviation occurred during a period of startup, shutdown, or malfunction, or during another period.~~

4. ~~Deviations from the requirement to have a qualified operator accessible shall be reported as follows:~~

a. ~~If all qualified operators are not accessible for two weeks or more, the owner shall:~~

(1) ~~Submit a notification of the deviation within 10 days that includes a statement of what caused the deviation, a description of what is being done to ensure that a qualified operator is accessible, and the anticipated date when a qualified operator will be available; and~~

(2) ~~Submit a status report to the board every four weeks that includes a description of what is being done to ensure that a qualified operator is accessible, the anticipated date when a qualified operator will be accessible, and request for approval from the board to continue operation of the CISWI unit.~~

b. ~~If the unit was shut down by the board under the provisions of 9VAC5-40-6400 J 2 a due to a failure to provide an accessible qualified operator, the owner shall notify the board that the unit will resume operation once a qualified operator is accessible.~~

I. ~~Initial, annual, and deviation reports shall be submitted electronically or in paper format, postmarked on or before the submittal due dates.~~

J. ~~Semiannual or annual reporting dates may be changed with the approval of the board in accordance with the procedures in 40 CFR 60.19(e).~~

9VAC5-40-6490. Requirements for air Air curtain incinerators.

A. ~~The owner of an affected air curtain incinerator that plans to continue operation shall achieve final compliance by the date one year after the baseline compliance date. An air curtain incinerator that continues to operate after the date one year after the baseline compliance date without being in compliance with this article shall be considered to be in~~

~~violation of this article. The provisions of 40 CFR 60.2810 through 40 CFR 60.2870 apply.~~

B. ~~In order to achieve final compliance, the owner shall complete all equipment changes and retrofit installation of control devices so that when the affected air curtain incinerator is placed into service, all necessary equipment and air pollution control devices operate as designed and meet the opacity limits of subsection D of this section.~~

C. ~~The following shall be met if an air curtain incinerator is to be shut down:~~

1. ~~If an incinerator is shut down but will be restarted prior to the final compliance date specified in subsection A of this section, the owner shall (i) achieve final compliance by the date one year after the baseline compliance date and (ii) meet the federal operating permit requirements of 9VAC5-40-6250 F on the date the incinerator restarts operation.~~

2. ~~If an incinerator is shut down but will be restarted after the date one year after the baseline compliance date, the owner shall (i) complete any needed emission control retrofits, (ii) meet the opacity limits of subsection D of this section, and (iii) meet the federal operating permit requirements of 9VAC5-40-6250 F on the date the incinerator restarts operation.~~

3. ~~If an incinerator is permanently shut down, the owner shall (i) submit a closure notification, including the date of closure, to the board 180 days after the final compliance date specified in subsection A of this section and (ii) meet the federal operating permit requirements of 9VAC5-40-6250 F regardless of when shutdown occurs.~~

D. ~~After the date the initial emission test is required or completed (whichever is earlier), no owner or other person shall cause or permit to be discharged into the atmosphere from any affected air curtain incinerator any emissions in excess of the following limits:~~

1. ~~The opacity limitation is 10% (six minute average), except as described in subdivision 2 of this subsection.~~

2. ~~The opacity limitation is 35% (six minute average) during the startup period that is within the first 30 minutes of operation.~~

E. ~~Except during malfunctions, the requirements of this article shall apply at all times, and each malfunction shall not exceed three hours.~~

F. ~~Air curtain incinerators shall meet the following requirements to determine compliance with the opacity limitation:~~

1. ~~Compliance with the opacity limitation shall be determined using Reference Method 9.~~

2. ~~An initial emission test for opacity shall be conducted no later than 90 days after the final compliance date specified in 9VAC5-40-6490 A.~~

~~3. After the initial emission test for opacity, annual emission tests shall be conducted no more than 12 calendar months following the date of the previous emission test.~~

~~G. The owner of an air curtain incinerator shall maintain records and submit reports as follows:~~

~~1. Records of results of all initial and annual emission tests for opacity shall be kept onsite in either paper copy or electronic format, unless the board approves another format, for at least five years.~~

~~2. All records shall be made available for submittal to the board or for an inspector's onsite review.~~

~~3. An initial report shall be submitted no later than 60 days following the initial emission test for opacity that includes the following information:~~

~~a. The types of materials to be combusted.~~

~~b. The results (each six minute average) of the initial emission tests for opacity.~~

~~4. Annual emission test results for opacity shall be submitted within 12 months following the previous report.~~

~~5. Initial and annual emission test reports for opacity shall be submitted as electronic or paper copy on or before the applicable submittal date. A copy shall be maintained onsite for a period of five years.~~

~~H. For purposes of this section, the term "shutdown" shall have the meaning specified in 9VAC5 Chapter 10.~~

9VAC5-40-6510. Permits.

A permit may be required prior to beginning any of the activities specified below if the provisions of ~~9VAC5 Chapter 50 and 9VAC5 Chapter 80~~ 9VAC5-50 (New and Modified Stationary Sources) and 9VAC5-80 (Permits for Stationary Sources) apply. Owners contemplating such action should review those provisions and contact the appropriate regional office for guidance on whether those provisions apply.

1. Construction of a facility.
2. Reconstruction (replacement of more than half) of a facility.
3. Modification (any physical change to equipment) of a facility.
4. Relocation of a facility.
5. Reactivation (~~restart up~~) (re-startup) of a facility.
6. Operation of a facility.

9VAC5-40-6520. Documents incorporated by reference.

A. The United States Environmental Protection Agency (EPA) regulations promulgated at Subpart DDDD (Emissions Guidelines and Compliance Times for Commercial and Industrial Solid Waste Incineration Units that Commenced Construction On or Before November 30, 1999) of 40 CFR Part 60 and designated in subsection B of this section are incorporated by reference into this article. The 40 CFR section numbers appearing in subsection B of this section identify the specific provisions incorporated by reference.

The specific version of the provisions incorporated by reference shall be that contained in the CFR in effect as specified in 9VAC5-20-21 B.

B. The following documents from the United States Environmental Protection Agency are incorporated herein by reference:

Model Rule, Increments of Progress

§ 60.2575, What are my requirements for meeting increments of progress and achieving final compliance?

§ 60.2580, When must I complete each increment of progress?

§ 60.2585, What must I include in the notifications of achievement of increments of progress?

§ 60.2590, When must I submit the notifications of achievement of increments of progress?

§ 60.2595, What if I do not meet an increment of progress?

§ 60.2600, How do I comply with the increment of progress for submittal of a control plan?

§ 60.2605, How do I comply with the increment of progress for achieving final compliance?

§ 60.2610, What must I do if I close my CISWI unit and then restart it?

§ 60.2615, What must I do if I plan to permanently close my CISWI unit and not restart it?

Model Rule, Waste Management Plan

§ 60.2620, What is a waste management plan?

§ 60.2625, When must I submit my waste management plan?

§ 60.2630, What should I include in my waste management plan?

Model Rule, Operator Training and Qualification

§ 60.2635, What are the operator training and qualification requirements?

§ 60.2640, When must the operator training course be completed?

§ 60.2645, How do I obtain my operator qualification?

§ 60.2650, How do I maintain my operator qualification?

§ 60.2655, How do I renew my lapsed operator qualification?

§ 60.2660, What site-specific documentation is required?

§ 60.2665, What if all the qualified operators are temporarily not accessible?

Model Rule, Emission Limitations and Operating Limits

§ 60.2670, What emission limitations must I meet and by when?

§ 60.2675, What operating limits must I meet and by when?

§ 60.2680, What if I do not use a wet scrubber, fabric filter, activated carbon injection, selective noncatalytic reduction, an electrostatic precipitator, or a dry scrubber to comply with the emission limitations?

Regulations

§ 60.2685, Affirmative Defense for Violation of Emission Standards During Malfunction.

Model Rule, Performance Testing

§ 60.2690, How do I conduct the initial and annual performance test?

§ 60.2695, How are the performance test data used?

Model Rule, Initial Compliance Requirements

§ 60.2700, How do I demonstrate initial compliance with the emission limitations and establish the operating limits?

§ 60.2705, By what date must I conduct the initial performance test?

§ 60.2706, Reserved

Model Rule, Continuous Compliance Requirements

§ 60.2710, How do I demonstrate continuous compliance with the emission limitations and the operating limits?

§ 60.2715, By what date must I conduct the annual performance test?

§ 60.2716, Reserved

§ 60.2720, May I conduct performance testing less often?

§ 60.2725, May I conduct a repeat performance test to establish new operating limits?

Model Rule, Monitoring

§ 60.2730, What monitoring equipment must I install and what parameters must I monitor?

§ 60.2735, Is there a minimum amount of monitoring data I must obtain?

Model Rule, Recordkeeping and Reporting

§ 60.2740, What records must I keep?

§ 60.2745, Where and in what format must I keep my records?

§ 60.2750, What reports must I submit?

§ 60.2755, When must I submit my waste management plan?

§ 60.2760, What information must I submit following my initial performance test?

§ 60.2765, When must I submit my annual report?

§ 60.2770, What information must I include in my annual report?

§ 60.2775, What else must I report if I have a deviation from the operating limits or the emission limitations?

§ 60.2780, What must I include in the deviation report?

§ 60.2785, What else must I report if I have a deviation from the requirement to have a qualified operator accessible?

§ 60.2790, Are there any other notifications or reports that I must submit?

§ 60.2795, In what form can I submit my reports?

§ 60.2800, Can reporting dates be changed?

Model Rule, Title V Operating Permits

§ 60.2805, Am I required to apply for and obtain a title V operating permit for my unit?

Model Rule, Air Curtain Incinerators

§ 60.2810, What is an air curtain incinerator?

§ 60.2815, What are my requirements for meeting increments of progress and achieving final compliance?

§ 60.2820, When must I complete each increment of progress?

§ 60.2825, What must I include in the notifications of achievement of increments of progress?

§ 60.2830, When must I submit the notifications of achievement of increments of progress?

§ 60.2835, What if I do not meet an increment of progress?

§ 60.2840, How do I comply with the increment of progress for submittal of a control plan?

§ 60.2845, How do I comply with the increment of progress for achieving final compliance?

§ 60.2850, What must I do if I close my air curtain incinerator and then restart it?

§ 60.2855, What must I do if I plan to permanently close my air curtain incinerator and not restart it?

§ 60.2860, What are the emission limitations for air curtain incinerators?

§ 60.2865, How must I monitor opacity for air curtain incinerators?

§ 60.2870, What are the recordkeeping and reporting requirements for air curtain incinerators?

Model Rule, Definitions

§ 60.2875, What definitions must I know?

TABLES

Table 2 to Subpart DDDD of Part 60, Model Rule, Emission Limitations that Apply to Incinerators on or after February 7, 2018.

Table 3 to Subpart DDDD of Part 60, Model Rule, Operating Limits for Wet Scrubbers.

Table 4 to Subpart DDDD of Part 60, Model Rule, Toxic Equivalency Factors.

Table 5 to Subpart DDDD of Part 60, Model Rule, Summary of Reporting Requirements.

Table 6 to Subpart DDDD of Part 60, Emission Limitations that Apply to Incinerators on and after February 7, 2018.

Table 7 to Subpart DDDD of Part 60, Emission Limitations that Apply to Energy Recovery Units After May 20, 2011, on or after February 7, 2018.

Table 8 to Subpart DDDD of Part 60, Emission Limitations that Apply to Waste-Burning Kilns after February 7, 2018.

Table 9 to Subpart DDDD of Part 60, Emission Limitations that Apply to Small, Remote Incinerators after February 7, 2018.

VA.R. Doc. No. R13-3612; Filed July 10, 2013, 11:57 a.m.

Final Regulation

REGISTRAR'S NOTICE: The State Air Pollution Control Board is claiming an exclusion from the Administrative Process Act in accordance with § 2.2-4006 A 4 a of the Code of Virginia, which excludes regulations that are necessary to conform to changes in Virginia statutory law where no agency discretion is involved. The State Air Pollution Control Board will receive, consider, and respond to petitions by any interested person at any time with respect to reconsideration or revision.

Title of Regulation: 9VAC5-50. New and Modified Stationary Sources (repealing 9VAC5-50-430 through 9VAC5-50-600).

Statutory Authority: § 10.1-1308 of the Code of Virginia; §§ 110, 111, 123, 129, 171, 172, and 182 of the Clean Air Act; 40 CFR Parts 51 and 60.

Effective Date: August 28, 2013.

Agency Contact: Karen G. Sabasteanski, Department of Environmental Quality, 629 East Main Street, P.O. Box 1105, Richmond, VA 23218, telephone (804) 698-4426, FAX (804) 698-4510, TTY (804) 698-4021, or email karen.sabasteanski@deq.virginia.gov.

Summary:

Rule 5-6, Standards of Performance for Regulated Medical Waste Incinerators (Article 6 of 9VAC5-50) was originally adopted in response to a directive from the General Assembly in 1992 (Chapters 773, 774, and 751). Since Article 6 was adopted, a more restrictive U.S. Environmental Protection Agency new source performance standard covering the same type of sources was promulgated and adopted by Virginia. Because there is no longer a need for the original, less-restrictive Virginia regulation, the 2013 General Assembly enacted Chapter 632, which removes the provisions relevant to air quality from Chapters 773, 774, and 751. Article 6 of 9VAC5-50 is being repealed because its underlying state requirement has been removed.

Article 6

Standards of Performance for Regulated Medical Waste Incinerators (Rule 5-6) (Repealed)

9VAC5-50-430. Applicability and designation of affected facility. (Repealed.)

A. Except as provided in subsections C and D of this section, the affected facility to which the provisions of this article apply is each regulated medical waste incinerator.

B. The provisions of this article apply throughout the Commonwealth of Virginia.

C. The provisions of this article do not apply to incinerators the construction or modification of which as defined in 9VAC5 Chapter 80 (9VAC5 80-10 et seq.) commenced prior to September 1, 1993.

D. The provisions of this article do not apply to combustion units or incinerators burning materials that do not include regulated medical waste.

9VAC5-50-440. Definitions. (Repealed.)

A. For the purpose of these regulations and subsequent amendments or any orders issued by the board, the words or terms shall have the meanings given them in subsection C of this section.

B. As used in this article, all terms not defined here shall have the meanings given them in 9VAC5 Chapter 10 (9VAC5 10-10 et seq.), unless otherwise required by context.

C. Terms defined:

"Commercial regulated medical waste incinerator" means any regulated medical waste incinerator that burns regulated medical waste if more than 25% of such waste is generated off site.

"Continuous emission monitoring system" means a monitoring system for continuously measuring the emissions of a pollutant from an affected facility.

"Dioxins" and "furans" means tetra through octachlorinated dibenzo p dioxins and dibenzofurans.

"Four hour block average" means the average of all hourly emission rates or temperatures when the affected facility is operating and combusting regulated medical waste measured over four hour periods of time from midnight to 4 a.m., 4 a.m. to 8 a.m., 8 a.m. to noon, noon to 4 p.m., 4 p.m. to 8 p.m., 8 p.m. to midnight.

"Incinerator" means any furnace or device used in the process of burning any type of waste for the primary purpose of destroying matter or reducing the volume of the waste by removing combustible matter or both.

"On site" means (i) the same or geographically contiguous property which may be divided by a public or private right of way, provided the entrance and exit between the properties are at a crossroads intersection and access is by crossing, as opposed to going along, the right of way or (ii) noncontiguous properties owned by the same person but connected by a right of way controlled by the same person and to which the public does not have an access.

"Off site" means any site that does not meet the definition of on site.

"Pathological waste" means a solid waste that is human tissues, organs, body parts, fetuses, placentas, effluences or similar material, and animal tissue, organs, body parts, fetuses, placentas, effluence or similar material from animals exposed to human pathogens for purposes of testing or experimentation.

"Potential hydrogen chloride emission rate" means the hydrogen chloride emission rate that would occur from the combustion of regulated medical waste in the absence of any hydrogen chloride emissions control.

Regulations

~~"Rated capacity" means the waste charging rate expressed as the maximum capacity guaranteed by the equipment manufacturer or the maximum normally achieved during use, whichever is greater.~~

~~"Regulated medical waste" means any solid waste identified or suspected by the health care profession as being capable of producing an infectious disease in humans. A waste shall be considered to be capable of producing an infectious disease if it has been or is likely to have been contaminated by an organism likely to be pathogenic to humans, such organism is not routinely and freely available in the community, and such organism has a significant probability of being present in significant quantities and with sufficient virulence to transmit disease. In addition, regulated medical waste shall include the following:~~

- ~~a. Discarded cultures, stocks, specimens, vaccines, and associated items likely to have been contaminated with organisms likely to be pathogenic to humans, discarded etiologic agents, and wastes from production of biologicals and antibiotics likely to have been contaminated by organisms likely to be pathogenic to humans;~~
- ~~b. Wastes consisting of human blood, human blood products, and items contaminated by free flowing human blood;~~
- ~~c. Pathological wastes;~~
- ~~d. Used sharps likely to be contaminated with organisms that are pathogenic to humans, and all sharps used in patient care;~~
- ~~e. The carcasses, body parts, bedding material, and all other wastes of animals intentionally infected with organisms likely to be pathogenic to humans for purposes of research, in vivo testing, production of biological materials or any other reason, when discarded, disposed of, or placed in accumulated storage;~~
- ~~f. Any residue or contaminated soil, water, or debris resulting from cleanup of a spill of any regulated medical waste; and~~
- ~~g. Any waste contaminated by or mixed with regulated medical waste.~~

~~Regulated medical waste shall not include:~~

- ~~a. Wastes contaminated only with organisms which are not generally recognized as pathogenic to humans, even if those organisms cause disease in other plants or animals, and which are managed in complete accord with all regulations of the U.S. Department of Agriculture and the Virginia Department of Agriculture and Consumer Services;~~
- ~~b. Meat or other food items being discarded because of spoilage or contamination, unless included in subdivisions 1 through 7 above;~~
- ~~c. Garbage, trash, and sanitary waste from septic tanks, single or multiple residences, hotels, motels, bunkhouses,~~

~~ranger stations, crew quarters, campgrounds, picnic grounds, and day use recreation areas, except for waste generated by provision of professional health care services on the premises, provided that all medical sharps shall be placed in a container with a high degree of puncture resistance before being mixed with other wastes or discarded;~~

- ~~d. Used products for personal hygiene, such as diapers, facial tissues, and sanitary napkins; and~~
- ~~e. Material, not including sharps, containing small amounts of blood or body fluids, and no free flowing or unabsorbed liquid.~~

~~"Regulated medical waste incinerator" means any incinerator used in the process of burning regulated medical waste.~~

~~"Sharps" means needles, scalpels, knives, broken glass, syringes, pasteur pipettes and similar items having a point or sharp edge.~~

~~"Solid waste" shall have the meaning ascribed to it in § 10.1-1400 of the Code of Virginia. However, for purposes of this article, the following materials are not solid wastes:~~

- ~~a. Domestic sewage, including wastes that are not stored and are disposed of in a sanitary sewer system (with or without grinding);~~
- ~~b. Any mixture of domestic sewage and other wastes that pass through a sewer system to a wastewater treatment works permitted by the State Water Control Board or the Department of Health;~~
- ~~c. Human remains under the control of a licensed physician or dentist, when the remains are being used or examined for medical purposes and are not abandoned materials; and~~
- ~~d. Human remains properly interred in a cemetery or in preparation by a licensed mortician for such interment or cremation.~~

9VAC5-50-450. Standard for particulate matter. (Repealed.)

~~No owner or other person shall cause or permit to be discharged into the atmosphere from any regulated medical waste incinerator any particulate emissions in excess of the following limits:~~

- ~~1. For incinerators with a rated capacity equal to or greater than 1000 pounds per hour: 0.015 grains per dry standard cubic foot of exhaust gas corrected to 7.0% oxygen (dry basis).~~
- ~~2. For incinerators with a rated capacity equal to or greater than 500 pounds per hour and less than 1000 pounds per hour: 0.03 grains per dry standard cubic foot of exhaust gas corrected to 7.0% oxygen (dry basis).~~
- ~~3. For incinerators with a rated capacity less than 500 pounds per hour: 0.10 grains per dry standard cubic foot of exhaust gas corrected to 7.0% oxygen (dry basis).~~

9VAC5-50-460. ~~Standard for carbon monoxide. (Repealed.)~~

~~No owner or other person shall cause or permit to be discharged into the atmosphere from any regulated medical waste incinerator any carbon monoxide emissions in excess of 50 parts per million by volume dry average per operating cycle or per day, whichever is less in duration, corrected to 7.0% oxygen (dry basis). An operating cycle shall be the period of time from the initial loading of waste into the incinerator through the burn-down cycle.~~

9VAC5-50-470. ~~Standard for hydrogen chloride. (Repealed.)~~

~~No owner or other person shall cause or permit to be discharged into the atmosphere from any regulated medical waste incinerator any hydrogen chloride emissions in excess of the following limits:~~

- ~~1. For incinerators with a rated capacity equal to or greater than 500 pounds per hour and less than 1000 pounds per hour: 10% of the potential hydrogen chloride emission rate (90% reduction by weight or volume).~~
- ~~2. For incinerators with a rated capacity equal to or greater than 1000 pounds per hour: 5.0% of the potential hydrogen chloride emission rate (95% reduction by weight or volume).~~

9VAC5-50-480. ~~Standard for dioxins and furans. (Repealed.)~~

~~A. No owner or other person shall cause or permit to be discharged into the atmosphere from any regulated medical waste incinerator with a rated capacity equal to or greater than 500 pounds per hour any total dioxin or furan emissions in excess of 8 grains per billion dry standard cubic feet corrected to 7.0% oxygen (dry basis).~~

~~B. A waiver from the provisions of subsection A of this section may be obtained from the board upon a demonstration to the board's satisfaction that the maximum annual risk does not exceed 1 in 100,000. Ambient air concentrations and risk assessments shall be determined using air quality analysis techniques and methods acceptable to the board.~~

9VAC5-50-490. ~~Standard for visible emissions. (Repealed.)~~

~~A. The provisions of Article 1 (9VAC5 50 60 et seq.) of this chapter (Standards of Performance for Visible Emissions and Fugitive Dust/Emissions, Rule 5 1) apply except that the provisions in subsection B of this section apply instead of 9VAC5 50 80.~~

~~B. No owner or other person shall cause or permit to be discharged into the atmosphere from any regulated medical waste incinerator any visible emissions which exhibit greater than 10% opacity. Failure to meet the requirements of this section because of the presence of water vapor shall not be a violation of this section.~~

9VAC5-50-500. ~~Standard for fugitive dust/emissions. (Repealed.)~~

~~The provisions of Article 1 (9VAC5 50 60 et seq.) of this chapter (Standards of Performance for Visible Emissions and Fugitive Dust/Emissions, Rule 5 1) apply.~~

9VAC5-50-510. ~~Standard for odor. (Repealed.)~~

~~The provisions of Article 2 (9VAC5 50 130 et seq.) of this chapter (Standards of Performance for Odorous Emissions, Rule 5 2) apply.~~

9VAC5-50-520. ~~Standard for toxic pollutants. (Repealed.)~~

~~The provisions of Article 3 (9VAC5 50 160 et seq.) of this chapter (Standards of Performance for Toxic Pollutants, Rule 5 3) apply, including those provisions that apply to emissions of hydrogen chloride, except that the provisions of 9VAC5-50-480 apply to emissions of dioxins and furans.~~

9VAC5-50-530. ~~Standard for radioactive materials. (Repealed.)~~

~~Radioactive materials shall be handled in accordance with the regulations of the U.S. Environmental Protection Agency, the U.S. Nuclear Regulatory Commission, and the Virginia Department of Health.~~

9VAC5-50-540. ~~Compliance. (Repealed.)~~

~~A. In addition to the provisions of 9VAC5 50 20 (Compliance), the provisions of subsections B through D of this section apply.~~

~~B. The owner of an affected facility shall operate the facility within parameters as specified below in accordance with methods and procedures acceptable to the board.~~

- ~~1. The minimum primary chamber temperature shall be 1400°F or the manufacturer's recommended operating temperature, whichever is higher, for a period of time needed to achieve complete pyrolysis.~~
- ~~2. A secondary combustion chamber with afterburner is required. The minimum secondary chamber temperature shall be 1800°F or the manufacturer's recommended operating temperature, whichever is higher, for a period of no less than two seconds.~~
- ~~3. Combustion control systems shall include chamber thermostats to ensure that the auxiliary burners automatically ignite and fire in order to maintain the primary and secondary chamber temperatures.~~
- ~~4. An interlock system to prevent incinerator feeding prior to attaining the minimum secondary chamber temperature is required.~~
- ~~5. The minimum sorbent injection rate, expressed in pounds per hour of active neutralizing agent, shall be calculated as follows:~~

$$SI_{\min} = 1.2 (SI_{\text{test}})(\% \text{ ANA})$$

~~where:~~

~~SI_{\min} = minimum sorbent injection rate (pounds per hour);~~

Regulations

~~SI_{test} = pounds per hour of sorbent injected during the performance test, while the hydrogen chloride inlet concentration was highest.~~

~~% ANA = percent by weight of active neutralizing agent in the sorbent.~~

~~C. An owner may request that compliance with the applicable emission limit be determined using carbon dioxide measurements corrected to an equivalent of 7.0% oxygen. The relationship between oxygen and carbon dioxide levels for the affected facility shall be established during the initial performance tests. In such cases, the applicable emission limit shall be corrected to the established percentage of carbon dioxide without the contribution of auxiliary fuel carbon dioxide when using a fuel other than natural gas or liquefied petroleum gas.~~

~~D. All facilities are required to meet the compliance requirements of Part VII (9VAC20-120-520 et seq.) of 9VAC20 Chapter 120 (Regulated Medical Waste Management Regulations).~~

~~9VAC5-50-550. Test methods and procedures. (Repealed.)~~

~~A. In addition to the provisions of 9VAC5-50-30 (Performance testing), the provisions of subsections B through E of this section apply.~~

~~B. The owner of an affected facility shall conduct performance tests and reduce associated data as specified below in accordance with methods and procedures acceptable to the board.~~

~~1. For all incinerators: particulate matter, carbon monoxide and visible emissions.~~

~~2. For all incinerators with a rated capacity equal to or greater than 500 pounds per hour: hydrogen chloride emissions and control efficiency of any scrubber system used to control hydrogen chloride emissions. Hydrogen chloride performance tests shall begin no earlier than one hour after the initial loading of waste into the incinerator. Hourly feed rate during hydrogen chloride performance tests shall be determined as the total amount of waste loaded into the incinerator between the beginning of the first sampling run of the day and the end of the last sampling run of the day, divided by the total number of hours elapsed.~~

~~3. For all incinerators with a rated capacity equal to or greater than 500 pounds per hour: dioxin and furan emissions.~~

~~C. Frequency of testing as required in subsection B of this section shall be required as follows.~~

~~1. For all incinerators: on site initial performance tests.~~

~~2. For incinerators with a rated capacity equal to or greater than 1000 pounds per hour: on site annual performance tests for dioxins and furans.~~

~~D. Regulated medical waste incinerators which are of standardized manufacture and are shipped as assembled~~

~~incinerators from the factory of manufacture may be exempt from on site initial particulate matter and carbon monoxide performance testing, provided that:~~

~~1. The incinerator has a rated capacity of less than 100 pounds per hour;~~

~~2. The manufacturer has obtained a satisfactory test on an identical incinerator of similar size and design certified by a registered engineer;~~

~~3. The test has been certified for the same type of waste as designated for the incinerator subject to the permit; and~~

~~4. The test results are submitted to the board and found acceptable (waste type, incinerator design, acceptable feed range, equivalent operating parameters, equivalent auxiliary fuel, acceptable methodology).~~

~~E. Required on site testing shall be done while the incinerator is operated at 90% or greater of the rated capacity and operated by trained plant personnel only.~~

~~9VAC5-50-560. Monitoring. (Repealed.)~~

~~A. In addition to the provisions of 9VAC5-50-40 (Monitoring), the provisions of subsection B of this section apply.~~

~~B. The owner of an affected facility shall install, calibrate, maintain and operate equipment for continuously monitoring and recording emissions or process parameters or both as specified below in accordance with methods and procedures acceptable to the board.~~

~~1. For all incinerators with a rated capacity equal to or greater than 500 pounds per hour, continuous measurement and display is required for primary and secondary chamber temperatures. Thermocouples shall be located at or near the primary and secondary chamber exits.~~

~~2. For all incinerators with a rated capacity equal to or greater than 1000 pounds per hour, continuous recording is required for the secondary chamber temperature.~~

~~3. For all incinerators with a rated capacity equal to or greater than 1000 pounds per hour, continuous measurement, display and recording is required for opacity, with the output of the system recording on a six-minute average basis.~~

~~4. For all incinerators with a rated capacity equal to or greater than 1000 pounds per hour, continuous measurement, display and recording is required for carbon monoxide emissions, with carbon dioxide or oxygen diluent monitor.~~

~~5. A pH meter is required for each wet scrubber system.~~

~~6. A flow meter to measure the sorbent injection rate is required for each wet scrubber system.~~

9VAC5-50-570. Notification, records and reporting. (Repealed.)

~~A. In addition to the provisions of 9VAC5-50-50 (Notification, records and reporting), the provisions of subsections B through F of this section apply.~~

~~B. Following initial notification as required under 9VAC5-50-50 A 3, the owner of an affected facility shall submit the initial performance test data and the performance evaluation of the continuous emission monitoring systems using the applicable performance specifications in 40 CFR 60 Appendix B.~~

~~C. Following initial notification as required under 9VAC5-50-50 A 3, the owner of an affected facility shall submit quarterly compliance reports for hydrogen chloride, carbon monoxide, and secondary combustion chamber temperature to the board containing the information for each applicable pollutant or parameter. The hourly average values recorded under subdivision F 2 of this section are not required to be included in the quarterly reports. Such reports shall be postmarked no later than the 30th day following the end of each calendar quarter.~~

~~D. The owner of an affected facility shall submit quarterly excess emission reports, as applicable, for opacity. The quarterly excess emission reports shall include all information recorded under this subsection which pertains to opacity, and a listing of the six minute average opacity levels recorded under this subsection for all periods when such six minute average levels exceeded the opacity limit under 9VAC5-50-490. The quarterly report shall also list the percentage of the affected facility operating time for the calendar quarter during which the opacity continuous emission monitoring system was operating and collecting valid data. Such excess emission reports shall be postmarked no later than the 30th day following the end of each calendar quarter.~~

~~E. The owner of an affected facility shall submit reports to the board of all annual performance tests for dioxins and furans from the affected facility. Such reports shall be submitted when available but in no case later than the date of the required submittal of the quarterly report specified under subsection C of this section covering the calendar quarter following the quarter during which the test was conducted.~~

~~F. The owner of an affected facility shall maintain and make available to the board upon request records of the following information for a period of at least five years:~~

- ~~1. Dates of emission tests and continuous monitoring measurements.~~
- ~~2. The emission rates and parameters measured using performance tests or continuous emission or parameter monitoring, as applicable, as follows:

 - ~~a. The following measurements shall be recorded in computer readable format and on paper:

 - ~~(1) The six minute average opacity levels;~~~~~~

~~(2) All one hour average hydrogen chloride emission rates at the inlet and outlet of the acid gas control device; and~~

~~(3) All one hour average carbon monoxide emission rates and secondary combustion chamber temperatures.~~

~~b. The following average rates shall be computed and recorded:~~

~~(1) All 24 hour daily arithmetic average percentage reductions in hydrogen chloride emissions and all 24-hour daily arithmetic average hydrogen chloride emission rates;~~

~~(2) All operating cycle or 24 hour daily arithmetic average carbon monoxide emission rates, as applicable; and~~

~~(3) All four hour block arithmetic average secondary combustion chamber temperatures.~~

~~3. Identification of the operating days when any of the average emission rates, percentage reductions, or operating parameters specified under this subsection or the opacity level have exceeded the applicable limit, with reasons for such exceedances as well as a description of corrective actions taken.~~

~~4. Identification of operating days for which the minimum number of hours of emissions rate or operational data have not been obtained, including reasons for not obtaining sufficient data and a description of corrective actions taken.~~

~~5. Identification of the times when emissions rate data have been excluded from the calculation of average emission rates or parameters and the reasons for excluding data.~~

~~6. The results of daily carbon monoxide continuous emission monitor system drift tests and accuracy assessments as required under 40 CFR 60, Appendix F, Procedure I.~~

~~7. The results of all applicable performance tests conducted to determine compliance with the particulate matter, carbon monoxide, dioxins and furans, and hydrogen chloride limits.~~

~~8. Records of continuous emission or parameter monitoring system data for opacity, carbon monoxide, and secondary combustion chamber temperature.~~

~~9. For commercial regulated medical waste incinerators, records of the amount and types of waste brought in from off-site.~~

9VAC5-50-580. Registration. (Repealed.)

~~The provisions of 9VAC5-20-160 (Registration) apply.~~

9VAC5-50-590. Facility and control equipment maintenance or malfunction. (Repealed.)

~~The provisions of 9VAC5-20-180 (Facility and control equipment maintenance or malfunction) apply.~~

Regulations

9VAC5-50-600. Permits. (Repealed.)

~~A permit may be required prior to beginning any of the activities specified below if the provisions of this chapter and 9VAC5 Chapter 80 (9VAC5 80 10 et seq.) apply. Owners contemplating such action should review those provisions and contact the appropriate regional office for guidance on whether those provisions apply.~~

- ~~1. Construction of a facility.~~
- ~~2. Reconstruction (replacement of more than half) of a facility.~~
- ~~3. Modification (any physical change to equipment) of a facility.~~
- ~~4. Relocation of a facility.~~
- ~~5. Reactivation (re-startup) of a facility.~~

VA.R. Doc. No. R13-3610; Filed July 10, 2013, 11:52 a.m.

Final Regulation

REGISTRAR'S NOTICE: The State Air Pollution Control Board is claiming an exclusion from the Administrative Process Act in accordance with § 2.2-4006 A 4 a of the Code of Virginia, which excludes regulations that are necessary to conform to changes in Virginia statutory law where no agency discretion is involved. The State Air Pollution Control Board will receive, consider, and respond to petitions by any interested person at any time with respect to reconsideration or revision.

Title of Regulation: **9VAC5-91. Regulations for the Control of Motor Vehicle Emissions in the Northern Virginia Area (amending 9VAC5-91-20, 9VAC5-91-30, 9VAC5-91-50, 9VAC5-91-70, 9VAC5-91-330, 9VAC5-91-360, 9VAC5-91-390, 9VAC5-91-410, 9VAC5-91-420, 9VAC5-91-430, 9VAC5-91-440, 9VAC5-91-570, 9VAC5-91-640, 9VAC5-91-650, 9VAC5-91-660, 9VAC5-91-670, 9VAC5-91-680, 9VAC5-91-690, 9VAC5-91-700, 9VAC5-91-710, 9VAC5-91-720; adding 9VAC5-91-665, 9VAC5-91-675; repealing 9VAC5-91-200, 9VAC5-91-450).**

Statutory Authority: § 46.2-1180 of the Code of Virginia; § 182 of the federal Clean Air Act; 40 CFR Part 51, Subpart S.

Effective Date: August 28, 2013.

Agency Contact: Mary E. Major, Department of Environmental Quality, 629 East Main Street, P.O. Box 1105, Richmond, VA 23218, telephone (804) 698-4423, FAX (804) 698-4510, TTY (804) 698-4021, or email mary.major@deq.virginia.gov.

Background: The current emissions inspection program requires that affected vehicles be presented to emissions inspection stations biennially to receive an emissions inspection. The geographic coverage of the program consists of the counties of Arlington, Fairfax, Loudoun, Prince William, and Stafford; and the cities of Alexandria, Fairfax, Falls Church, Manassas, and Manassas Park. Cars and trucks weighing up to 10,000 pounds and that are 25 years old and

newer are subject to an exhaust emissions inspection using ASM equipment, which tests cars under "loaded" conditions using a dynamometer. On-Board Diagnostics Systems (OBD) on vehicles so equipped will also be inspected. In addition, random testing of vehicles is accomplished using either roadside pullovers or a remote sensing device next to the roadway. Failing vehicles are required to report to an inspection for an out-of-cycle test.

Summary:

Amendments are made to conform vehicle inspection regulations to state law as follows:

- 1. Chapters 216 and 824 of the 2012 Acts of Assembly authorized the Director of the Department of Environmental Quality to enter into an agreement to designate a program coordinator to implement all inspection programs, except those utilizing remote sensing. It also stipulated that the director shall determine the services to be provided by the program coordinator and the amount to be paid to the program coordinator for such services.*
- 2. Chapter 348 of the 2013 Acts of Assembly provides for the electronic transmittal of certain documents.*
- 3. Chapter 634 of the 2013 Acts of the Assembly provides for the exemption from testing for certain hybrid vehicles.*

9VAC5-91-20. Terms defined.

"Aborted test" means an emissions inspection procedure that has been initiated by the inspector but stopped and not completed due to inspector error or a vehicular problem that prevents completion of the test. Aborted tests are not tests that cannot be completed due to a "failed/invalid" result caused by an exhaust dilution problem or an engine condition that prevents the inspection from being completed.

"Acceleration Simulation Mode (ASM) 50-15 equipment" means dynamometer-based emissions test equipment used to perform an enhanced emissions test in one or more, discreet, simulated road speed and engine load modes.

"Acceleration Simulation Mode (ASM) 25-25 standards" means the standards utilized for one of the discreet modes of the ASM test of the enhanced emission inspection program.

"Access code" means the security phrase or number which allows authorized station personnel, the department, and analyzer service technicians to perform specific assigned functions using the certified analyzer system, as determined by the department. Depending on the assigned function, the access code is a personal password, a state password or a service password. Access code is not an identification number, but is used as an authenticator along with the identification number where such number is needed to perform specific tasks.

"Actual gross weight" means the gross vehicle weight rating (GVWR).

"Administrator" means the administrator of the U.S. Environmental Protection Agency (EPA) or an authorized representative.

"Affected motor vehicle" means any motor vehicle or replica vehicle which:

1. Was manufactured or designated by the manufacturer as a model year less than 25 calendar years prior to January 1 of the present calendar year according to the formula, the current calendar year minus 24, except those identified by remote sensing as specified in subdivision 5 of this definition;
2. Is designed for the transportation of persons or property;
3. Is powered by an internal combustion engine;
4. For the Northern Virginia Emissions Inspection Program, has an actual gross weight of 10,000 pounds or less; and
5. For vehicles subject to the remote sensing requirements of 9VAC5-91-180, was designated by the manufacturer as model year 1968 or newer.

The term "affected motor vehicle" does not mean any:

1. Vehicle powered by a clean special fuel as defined in § 46.2-749.3 of the Code of Virginia, provided the federal Clean Air Act permits such exemptions for vehicles powered by clean special fuels;
2. Motorcycle;
3. Vehicle that at the time of its manufacture was not designed to meet emissions standards set or approved by the federal government;
4. Any antique motor vehicle as defined in § 46.2-100 of the Code of Virginia and licensed pursuant to § 46.2-730 of the Code of Virginia;
5. Firefighting equipment, rescue vehicle, or ambulance;
6. Vehicle for which no testing standards have been adopted by the board;
7. Tactical military vehicle; or
8. Qualified hybrid motor vehicle if such vehicle obtains a rating from the U.S. Environmental Protection Agency of at least 50 miles per gallon, or 48 miles per gallon for model years 2008 or 2009, during city fuel economy tests unless identified by the remote sensing requirements of 9VAC5-91-180 as violating the on-road high emitter emissions standards for on-road testing.

"Air intake systems" means those systems that allow for the induction of ambient air (to include preheated air) into the engine combustion chamber for the purpose of mixing with a fuel for combustion.

"Air pollution" means the presence in the outdoor atmosphere of one or more substances which are or may be harmful or injurious to human health, welfare or safety; to animal or plant life; or to property; or which unreasonably interfere with the enjoyment by the people of life or property.

"Air Pollution Control Law" means Chapter 13 (§ 10.1-1300 et seq.) of Title 10.1 of the Code of Virginia.

"Air system" or "air injection system" means a system for providing supplementary air to promote further oxidation of hydrocarbons and carbon monoxide gases and to assist catalytic reaction.

"Alternative fuel" means an internal combustion engine fuel other than (i) gasoline, (ii) diesel, or (iii) fuel mixtures containing more than 15% volume of gasoline.

"Alternative method" means any method of sampling and analyzing for an air pollutant that is not a reference method, but that has been demonstrated to the satisfaction of the board, in specific cases, to produce results adequate for its determination of compliance.

"Authorized personnel" means department personnel, an individual designated by analyzer system manufacturer, station owner, licensed emissions inspector, program coordinator, station manager or other person as designated by the station manager.

"Basic engine systems" means those parts or assemblies which provide for the efficient conversion of a compressed air and fuel charge into useful power to include but not limited to valve train mechanisms, cylinder head to block integrity, piston-ring-cylinder sealing integrity and post-combustion emissions control device integrity.

~~"Basic test and repair program" means a motor vehicle emissions inspection system established by this chapter that designates the use of an OBD II (on board diagnostic system) with wireless capability and a two speed idle analyzer as the only authorized testing equipment. Only those computer software programs and emissions testing procedures necessary to comply with the applicable provisions of Title I of the federal Clean Air Act shall be included. Such testing equipment shall be approvable for motor vehicle manufacturers' warranty repairs.~~

~~"Bi-fuel" means any motor vehicle capable of operating on one of two different fuels, usually gasoline and an alternative fuel, but not a mixture of the fuels. That is, only one fuel at a time.~~

"Board" means the State Air Pollution Control Board or its designated representative.

"Calibration" means establishing or verifying the response curve of a measurement device using several different measurements having precisely known quantities.

"Calibration gases" means gases of precisely known concentrations that are used as references for establishing or verifying the response curve of a measurement device.

~~"Canister" means a mechanical device capable of adsorbing and retaining hydrocarbon vapors.~~

"Catalytic converter" means a post combustion device that oxidizes hydrocarbons, carbon monoxide gases, and may also reduce oxides of nitrogen.

Regulations

"Certificate of emissions inspection" means a document, device, or symbol, whether recorded in written or electronic form, as prescribed by the director and issued pursuant to this chapter, which indicates that (i) an affected motor vehicle has satisfactorily complied with the emissions standards and passed the emissions inspection provided for in this chapter; (ii) the requirement of compliance with the emissions standards has been temporarily waived; or (iii) the affected motor vehicle has failed the emissions inspection.

"Certified emissions repair facility" means a facility, or portion of a facility, that has obtained a certification in accordance with Part VII (9VAC5-91-500 et seq.) to perform emissions related repairs on motor vehicles.

"Certified emissions repair technician" means a person who has obtained a certification in accordance with Part VIII (9VAC5-91-550 et seq.) to perform emissions related repairs on motor vehicles.

"Certified enhanced analyzer system" or "analyzer system" means the complete system that samples and reads concentrations of hydrocarbon, carbon dioxide, nitric oxides and carbon monoxide gases or interrogates the vehicle OBD system or both, and that is approved by the department for use in the Enhanced Emissions Inspection Program in accordance with Part X (9VAC5-91-640 et seq.). The analyzer system includes the exhaust gas handling system, the exhaust gas analyzer, ~~evaporative system pressure test equipment~~, associated automation hardware and software, data media, the analyzer system cabinet, ~~the dynamometer and appurtenant devices~~ dynamometer control devices, vehicle identification equipment, printer, and ~~associated cooling and exhaust fans and gas cylinders~~ calibration gases. The analyzer system does not include the dynamometer and associated cooling and exhaust fans that are supplied by the inspection station.

"Certified thermometer" means a laboratory grade ambient temperature-measuring device with a range of at least 20°F through 120°F, and an attested accuracy of at least 1°F with increments of 1°, with protective shielding.

"Chargeable inspection" means a completed inspection on an affected motor vehicle, for which the station owner is entitled to collect an inspection fee. No fee shall be paid for (i) inspections for which a certificate of emissions inspection has not been issued, (ii) inspections that are conducted by the department for referee purposes, (iii) inspections which were ordered due to on-road test failures but which result in an emissions inspection "pass" at an inspection station, or (iv) the first reinspection done at the same station that performed the initial inspection within 14 days. An inspection ordered by the department due to an on-road test failure that results in a confirmation test failure at an emissions inspection station is a chargeable inspection.

"Clean screen vehicle" means a vehicle that has been identified by the on-road inspector as having met the criteria

in 9VAC5-91-185 A or B and is eligible to participate in the on-road clean screen program.

"Clean screen vehicle notification" means a document, device, or symbol, whether recorded in written or electronic form, as prescribed by the director and issued pursuant to this chapter, that (i) indicates that an affected motor vehicle has satisfactorily complied with the clean screen vehicle emissions standards for on-road testing, and (ii) may be used by the motor vehicle owner to voluntarily comply with the vehicle registration requirements of § 46.2-1183 of the Code of Virginia. The notification shall also indicate that the motor vehicle owner may obtain an emissions inspection from an emissions inspection station.

"Clean screen vehicle standard" means any provision of 9VAC5-91-185 that prescribes an emission limitation, or other criteria used to select clean screen vehicles.

"Confirmation test" means an emissions inspection required due to a determination that the vehicle exceeds the on-road high emitter emissions standards prescribed in 9VAC5-91-180 B. The confirmation emissions inspection procedure may include an exhaust test (ASM or TSI), OBD system test or both.

"Consent order" means a mutual agreement between the department and any owner, operator, emissions inspector, or emissions repair technician that such owner or other person will perform specific actions for the purpose of diminishing or abating the causes of air pollution or for the purpose of coming into compliance with this chapter. A consent order may include agreed upon civil charges. Such orders may be issued without a formal hearing.

"Curb idle" means vehicle operation whereby the transmission is disengaged and the engine is operated with the throttle in the closed or idle stop position with the resultant engine speed between 400 and 1,250 revolutions per minute (rpm), or at another idle speed if so specified by the manufacturer.

"Data handling system" means all the computer hardware, software and peripheral equipment used to conduct emissions inspections and manage the enhanced emissions inspection program.

~~"Data medium" or "data media"~~ means the ~~medium~~ media contained in the certified analyzer system and used to electronically record test data.

"Day" means a 24-hour period beginning at midnight.

~~"Dedicated alternative fuel vehicle" means a vehicle that was configured by the vehicle manufacturer to operate only on one specific fuel other than (i) gasoline, (ii) diesel, or (iii) fuel mixtures containing more than 15% by volume of gasoline.~~

~~"Dedicated fuel vehicle" means a vehicle that was designed and manufactured to operate and operates on one specific fuel.~~

"Department" means any employee or other representative of the Virginia Department of Environmental Quality, as designated by the director.

"Director" means the director of the Virginia Department of Environmental Quality or a designated representative.

~~"Dual fuel" means a vehicle that operates on a combination of fuels, usually gasoline or diesel and an alternative fuel, at the same time. That is, the mixed fuels are introduced into the combustion chamber of the engine.~~

"Emissions control equipment" means any part, assembly or equipment originally installed by the manufacturer in or on a motor vehicle for the sole or primary purpose of reducing emissions.

"Emissions control systems" means any system consisting of parts, assemblies or equipment originally installed by the manufacturer in or on a motor vehicle for the primary purpose of reducing emissions.

"Emissions inspection" means an emissions inspection of a motor vehicle performed by an emissions inspector employed by or working at an emissions inspection station or fleet emissions inspection station, using the tests, procedures, and provisions set forth in this chapter.

"Emissions inspection station" means a facility or portion of a facility that has obtained an emissions inspection station permit from the director authorizing the facility to perform emissions inspections in accordance with the provisions of this chapter.

"Emissions inspector" means, except for an on-road emissions inspector, a person licensed by the department to perform inspections of vehicles required under the Virginia Motor Vehicle Emissions Control Law and is qualified in accordance with this chapter.

"Emissions standard" means any provision of Part III (9VAC5-91-160 et seq.) or Part XIV (9VAC5-91-790 et seq.) that prescribes an emission limitation, or other emission control requirements for motor vehicle air pollution.

"Empty weight (EW)" means that weight stated as the EW on a Virginia motor vehicle registration or derived from the motor vehicle title or manufacturer's certificate of origin. The EW may be used to determine emissions inspection standards.

"Enhanced emissions inspection program" means a motor vehicle emissions inspection system established by this chapter that designates, as the only authorized testing equipment for emissions inspection stations, (i) the use of the ASM 50-15 (acceleration simulation mode or method) together with an OBD-II (on-board diagnostic system) with wireless capability, (ii) the use of the ASM 50-15 together with the use of a dynamometer, and (iii) two-speed tailpipe testing equipment. Possession and availability of a dynamometer shall be required for enhanced emissions inspection stations. Only those computer software programs and emissions testing procedures necessary to comply with

applicable provisions of Title I of the federal Clean Air Act shall be included. Such testing equipment shall be approvable for motor vehicle manufacturers' warranty repairs. An enhanced emissions inspection program shall include remote sensing and an on-road clean screen program as provided in this chapter.

"EPA" means the United States Environmental Protection Agency.

"Equivalent test weight (ETW)" or "emission test weight" means the weight of a motor vehicle as automatically determined by the emissions analyzer system based on vehicle make, model, body, style, model year, engine size, permanently installed equipment, and other manufacturer and aftermarket supplied information, and used for the purpose of assigning dynamometer resistance and exhaust emissions standards for the conduct of an exhaust emissions inspection.

~~"Evaporative system pressure test" or "pressure test" means a physical test of the evaporative emission control system on a motor vehicle to determine whether the evaporative system vents emissions of volatile organic compounds from the fuel tank and fuel system to an on-board emission control device, and prevents their release to the ambient air under normal vehicle operating conditions. Such testing shall only be conducted at emissions inspection stations upon installation of approved equipment and software necessary for performing the test, as determined by the director.~~

"Exhaust gas analyzer" or "gas analyzer" means an ~~instrument~~ exhaust gas handling system that is capable of measuring the concentrations of certain air pollutants in the exhaust gas from a motor vehicle.

"Facility" means something that is built, installed or established to serve a particular purpose; includes, but is not limited to, buildings, installations, public works, businesses, commercial and industrial plants, shops and stores, apparatus, processes, operations, structures, and equipment of all types.

"Federal Clean Air Act" means Chapter 85 (§ 7401 et seq.) of Title 42 of the United States Code.

"Fleet" means 20 or more motor vehicles that are owned, operated, leased or rented for use by a common owner.

"Fleet emissions inspection station" means any inspection facility operated under a permit issued to a qualified fleet owner or lessee as determined by the director.

~~"Flexible fuel vehicle" means any motor vehicle capable of operating on two or more fuels, either one at a time or any mixture of two or more different fuels.~~

"Formal hearing" means a board or department process that provides for the right of private parties to submit factual proofs as provided in § 2.2-4020 of the Administrative Process Act in connection with case decisions. Formal hearings do not include the factual inquiries of an informal nature provided in § 2.2-4019 of the Administrative Process Act.

Regulations

"Fuel control systems" means those mechanical, electro-mechanical, galvanic or electronic parts or assemblies which regulate the air-to-fuel ratio in an engine for the purpose of providing a combustible charge.

~~"Fuel filler cap pressure test" or "gas cap pressure test" means a test of the ability of the fuel filler cap to prevent the release of fuel vapors from the fuel tank under normal operating conditions.~~

"Gas span" means the adjustment of an exhaust gas analyzer to correspond with known concentrations of gases.

"Gas span check" means a procedure using known concentrations of gases to verify the gas span adjustment of ~~an~~ a gas analyzer.

"Gross vehicle weight rating (GVWR)" means the maximum recommended combined weight of the motor vehicle and its load as prescribed by the manufacturer and is (i) expressed on a permanent identification label affixed to the motor vehicle; (ii) stated on the manufacturer's certificate of origin; or (iii) coded in the vehicle identification number. If the GVWR can be determined it shall be one element used to determine emissions inspection standards and test type. If the GVWR is unavailable, the department may make a determination based on the best available evidence including manufacturer reference, information coded in the vehicle identification number, or other available sources of information from which to make the determination.

"Heavy duty gasoline vehicle (HDGV)" means a heavy duty vehicle using gasoline as its fuel.

"Heavy duty vehicle (HDV)" means any affected motor vehicle (i) which is rated at more than 8,500 pounds GVWR or (ii) which has a loaded vehicle weight or GVWR of more than 6,000 pounds and has a basic frontal area in excess of 45 square feet.

"High emitter value" means the values in Table III-B of 9VAC5-91-180 that are used to determine vehicles in violation of the on-road high emitter emissions standard.

"Identification number" means the number assigned by the department to uniquely identify department personnel, an emissions inspection station, a certified emissions repair facility, a licensed emissions inspector, a certified emissions repair technician or other authorized personnel as necessary for specific tasks.

"Idle mode" means a condition where the vehicle engine is warm and running at the rate specified by the manufacturer as curb idle, where the engine is not propelling the vehicle, and where the throttle is in the closed or idle stop position.

"Ignition systems" means those parts or assemblies that are designed to cause and time the ignition of a compressed air and fuel charge.

"Implementation plan" means the plan, including any revision thereof, that has been submitted by the Commonwealth and approved in Subpart VV of 40 CFR Part 52 by the administrator under § 110 of the federal Clean Air

Act, or promulgated in Subpart VV of 40 CFR Part 52 by the administrator under § 110(c) of the federal Clean Air Act, or promulgated or approved by the administrator pursuant to regulations promulgated under § 301(d) of the federal Clean Air Act and that implements the relevant requirements of the federal Clean Air Act.

"Informal fact finding" means an informal conference or consultation proceeding used to ascertain the fact basis for case decisions as provided in § 2.2-4019 of the Administrative Process Act.

"Initial inspection" means the first complete emissions inspection of a motor vehicle conducted in accordance with the biennial inspection requirement and for which a valid vehicle emissions inspection report was issued. Any test following the initial inspection is a retest or reinspection.

"Inspection area" means in reference to an emissions inspection station, (i) the area that is occupied by the certified analyzer system and the vehicle being inspected or (ii) for only an OBD II test, the area within wireless range that is on the property on which the inspection station is located.

"Inspection fee" means the amount of money that (i) the emissions inspection station may collect from the motor vehicle owner for each chargeable inspection or (ii) an on-road emissions inspector may collect from the motor vehicle owner in response to a clean screen vehicle notification.

"Light duty gasoline vehicle (LDGV)" means a light duty vehicle using gasoline as its fuel.

"Light duty gasoline truck (LDGT1)" means a light duty truck 1 using gasoline as its fuel.

"Light duty gasoline truck (LDGT2)" means a light duty truck 2 using gasoline as its fuel.

"Light duty truck (LDT)" means any affected motor vehicle which (i) has a loaded vehicle weight or GVWR of 6,000 pounds or less and meets any one of the criteria below; or (ii) is rated at more than 6,000 pounds GVWR but less than 8,500 pounds GVWR and has a basic vehicle frontal area of 45 square feet or less; and meets one of the following criteria:

1. Designed primarily for purposes of transportation of property or is a derivation of such a vehicle.
2. Designed primarily for transportation of persons and has a capacity of more than 12 persons.
3. Equipped with special features enabling off-street or off-highway operation and use.

"Light duty truck 1 (LDT1)" means any light duty truck rated at 6,000 pounds GVWR or less. LDT1 is a subset of light duty trucks.

"Light duty truck 2 (LDT2)" means any light duty truck rated at greater than 6,000 pounds GVWR. LDT2 is a subset of light duty trucks.

"Light duty vehicle (LDV)" means an affected motor vehicle that is a passenger car or passenger car derivative capable of seating 12 passengers or less.

"Loaded vehicle weight (LVW)" or "curb weight" means the weight of a vehicle and its standard equipment; i.e., the empty weight as recorded on the vehicle's registration or the base shipping weight as recorded in the vehicle identification number, whichever is greater; plus the weight of any permanent attachments, the weight of a nominally filled fuel tank, plus 300 pounds.

"Locality" means a city, town, or county created by or pursuant to state law.

"Mobile fleet emissions inspection station" means a facility or entity that provides emissions inspection equipment or services to a fleet emissions inspection station on a temporary basis. Such equipment is not permanently installed at the fleet facility but is temporarily located at the fleet facility for the sole purpose of testing vehicles owned, operated, leased or rented for use by a common owner.

"Model year" means, except as may be otherwise defined in this chapter, the motor vehicle manufacturer's annual production period which includes the time period from January 1 of the calendar year prior to the stated model year to December 31 of the calendar year of the stated model year; provided that, if the manufacturer has no annual production period, the term "model year" shall mean the calendar year of manufacture. For the purpose of this definition, model year is applied to the vehicle chassis, irrespective of the year of manufacture of the vehicle engine.

"Monitors" means those computer programs in the on-board vehicle computer that evaluate the various emissions components and systems to determine status of such components and systems.

"Motor vehicle" means any motor vehicle as defined in § 46.2-100 of the Code of Virginia as a motor vehicle and that:

1. Is designed for the transportation of persons or property; and
2. Is powered by an internal combustion engine.

"Motor vehicle dealer" means a person who is licensed by the Department of Motor Vehicles in accordance with §§ 46.2-1500 and 46.2-1508 of the Code of Virginia.

"Motor vehicle emissions" means any emissions related information that can be captured through (i) a basic test and repair inspection, (ii) enhanced emissions inspection, or (iii) on-road testing.

"Motor vehicle inspection report" means a printed certificate of emissions inspection that is a report of the results of an emissions inspection. It indicates whether the motor vehicle has (i) passed, (ii) failed, or (iii) obtained a temporary emissions inspection waiver. It may also indicate whether the emissions inspection could not be completed due to an exhaust dilution or an engine condition that prevents the inspection from being completed. The report shall accurately identify the motor vehicle and shall include inspection results,

recall information provided by the department, warranty and repair information, and a unique identification number.

"Motor vehicle owner" means any person who owns, leases, operates, or controls a motor vehicle or fleet of motor vehicles.

"Nonconforming vehicle" means a vehicle not manufactured for sale in the United States to conform to emissions standards established by the federal government.

"Normal business hours" for emissions inspection stations, means a daily eight-hour period Monday through Friday, between the hours of 8 a.m. and 6 p.m., with the exception of national holidays, state holidays, temporary closures noticed to the department and closures due to the inability to meet the requirements of this chapter. Nothing in this chapter shall prevent stations from performing inspections at other times in addition to the "normal business hours." Emissions inspection stations may, with the approval of the department, substitute a combined total of eight hours, between 8 a.m. and 6 p.m., over a weekend period for one weekday as their "normal business hours" for conducting emission inspections. Emissions inspection stations shall post inspection hours.

"Northern Virginia emissions inspection program" means the emissions inspection program required by this chapter in the Northern Virginia program area.

"Northern Virginia program area" or "program area" means the territorial area encompassed by the boundaries of the following localities: the counties of Arlington, Fairfax, Loudoun, Prince William, and Stafford; and the cities of Alexandria, Fairfax, Falls Church, Manassas, and Manassas Park.

"On-board diagnostic system (OBD system)" means the computerized emissions control diagnostic system installed on model year 1996 and newer affected motor vehicles.

"On-board diagnostic system test (~~OBD~~ system test (OBD test)" means an evaluation of the OBD system pursuant to either 40 CFR 86.094-17 (2009 CFR) or 40 CFR 86.099-17 as applicable, according to procedures specified in 40 CFR 85.2222 and this chapter.

"On-board diagnostic vehicle (OBD vehicle)" means a model year 1996 and newer model affected motor vehicle equipped with an on-board diagnostic system and meeting the requirements of 40 CFR 85.2231.

"On-road clean screen program" means a program that allows a motor vehicle owner to voluntarily certify compliance with emissions standards by means of on-road remote sensing.

"On-road emissions inspector" means the entity or entities authorized by the Department of Environmental Quality to perform on-road testing, including on-road testing in accordance with the on-road clean screen program.

"On-road emissions measurement" means data obtained through on-road testing.

Regulations

"On-road high emitter emissions standard" means any provision of 9VAC5-91-180 that prescribes an emission limitation, or other emission control requirements for motor vehicle emissions. The on-road high emitter emissions standard shall be determined by multiplying the high emitter value in Table III-B of 9VAC5-91-180 with the appropriate ASM 25-25 standard in 9VAC5-91-810 or the TSI standard in Table III-A of 9VAC5-91-160.

"On-road testing" means tests of motor vehicle emissions or emissions control devices by means of roadside pullovers or remote sensing devices.

"Operated primarily" means motor vehicle operation that constitutes routine operation into or within the program area as evidenced by observation using remote sensing equipment at least three times in a 60-day period with no less than 30 days between the first and last observation. The director may increase the number of observations required for compliance determination if, in his discretion, based on program experience, such an increase would not significantly adversely impact the objectives of this chapter. The term "operated primarily" shall be used to identify motor vehicle operation that is subject to the exhaust emission standards for on-road testing through remote sensing set forth in 9VAC5-91-180. The term "operated primarily" shall not be used to identify motor vehicle operation that will subject the vehicle to the compliance provisions set forth in 9VAC5-91-160 and 9VAC5-91-170 for biennial emissions inspections.

"Order" means any decision or directive of the board or the director, including orders, consent orders, and orders of all types rendered for the purpose of diminishing or abating the causes of air pollution or enforcement of this chapter. Unless specified otherwise in this chapter, orders shall only be issued after the appropriate administrative proceeding.

~~"Original condition" means the condition of the vehicle, parts, and components as installed by the manufacturer but not necessarily to the original level of effectiveness.~~

"Owner" means any person who owns, leases, operates, controls or supervises a facility or motor vehicle.

"Party" means any person who actively participates in the administrative proceeding or offers comments through the public participation process and is named in the administrative record. The term "party" also means the department.

"Person" means an individual, corporation, partnership, association, a governmental body, a municipal corporation, or any other legal entity.

"Pollutant" means any substance the presence of which in the outdoor atmosphere is or may be harmful or injurious to human health, welfare or safety, to animal or plant life, or to property, or which unreasonably interferes with the enjoyment by the people of life or property.

"Program coordinator" means any person or corporation that has entered into a contract with the director to provide

services in accordance with Part X (9VAC5-91-640 et seq.) and other services not to include remote sensing.

"Qualified hybrid motor vehicle" means a motor vehicle that (i) meets or exceeds all applicable regulatory requirements, (ii) meets or exceeds the applicable federal motor vehicle emissions standards for gasoline-powered passenger cars, and (iii) can draw propulsion energy both from gasoline or diesel fuel and a rechargeable energy storage system.

"Reconstructed vehicle" means every vehicle of a type required to be registered under Title 46.2 (§ 46.2-100 et seq.) of the Code of Virginia, materially altered from its original construction by the removal, addition or substitution of new or used essential parts. Such vehicles, at the discretion of the Department of Motor Vehicles, shall retain their original vehicle identification number, line-make, and model year.

"Referee station" or "referee facility" means those facilities operated or used by the department to (i) determine program effectiveness, (ii) resolve emissions inspection conflicts between motor vehicle owners and emissions inspection stations, and (iii) provide such other technical support and information, as appropriate, to emissions inspection stations and motor vehicle owners.

"Reference method" means any method of sampling and analyzing for an air pollutant as described in Appendix A of 40 CFR Part 60.

"Reinspection" or "retest" means a type of inspection selected by the department or the emissions inspector when a request for an inspection is due to a previous failure. Any inspection that occurs 120 days or less following the most recent chargeable inspection is a retest.

"Rejected" or "rejected from testing" means that the vehicle cannot be inspected due to conditions in accordance with 9VAC5-91-420 C or 9VAC5-91-420 G 3.

"Remote sensing" means the measurement of motor vehicle emissions through electronic or light-sensing equipment from a remote location such as the roadside. Remote sensing equipment may include devices to detect and record the vehicle's registration or other identification numbers.

"Replica vehicle" means every vehicle of a type required to be registered under Title 46.2 (§ 46.2-100 et seq.) of the Code of Virginia not fully constructed by a licensed manufacturer but either constructed or assembled from components. Such components may be from a single vehicle, multiple vehicles, a kit, parts, or fabricated components. The kit may be made up of "major components" as defined in § 46.2-1600 of the Code of Virginia, a full body, or a full chassis, or a combination of these parts. The vehicle shall resemble a vehicle of distinctive name, line-make, model, or type as produced by a licensed manufacturer or manufacturer no longer in business and is not a reconstructed or specially constructed vehicle. Any vehicle registered as a replica vehicle shall meet emission requirements as established for the model year of which the vehicle is a replica.

"Sensitive mission vehicle" means any vehicle which, for law enforcement or national security reasons, cannot be tested in the public inspection system and must not be identified through the fleet testing system. For such vehicles, an autonomous fleet testing system may be established by agreement between the controlling agency and the director.

"Span gas" means gases of known concentration used as references to adjust or verify the accuracy of an exhaust gas analyzer that are approved by the department and are so labeled.

"Specially constructed vehicle" means any vehicle that was not originally constructed under a distinctive name, make, model, or type by a generally recognized manufacturer of vehicles and not a reconstructed vehicle as defined in this section.

"Specific engine family" means a group of motor vehicles with the same vehicle type, make, year, and engine size.

~~"Standard conditions" means a temperature of 20°C (68°F) and a pressure of 760 mm of H_g (29.92 inches of H_g).~~

"Standardized instruments" or "standardizing instruments" means laboratory instruments calibrated with precision gases traceable to the National Institute of Standards and Technology and accepted by the department as the standards to be used for comparison purposes. All candidate instruments are compared in performance to the standardized instruments.

"Tactical military vehicle" means any motor vehicle designed to military specifications or a commercially designed motor vehicle modified to military specifications to meet direct transportation support of combat, tactical, or military relief operations, or training of personnel for such operations.

"Tampering" means to alter, remove or otherwise disable or reduce the effectiveness of emissions control equipment on a motor vehicle.

"Test" means an emissions inspection of a vehicle, or any portion thereof, performed by an emissions inspector at an emissions inspection station, using the procedures and provisions set forth in this chapter.

"Test and repair" means motor vehicle emissions inspection stations that perform emissions inspections and may also perform vehicle repairs. No provision of this chapter shall bar emissions inspection stations from also performing vehicle repairs.

"Thermostatic air cleaner" means a system that supplies temperature-regulated air to the air intake system during engine operation.

~~"True concentration" means the concentration of the gases of interest as measured by a standardized instrument that has been calibrated with 1.0% precision gases traceable to the National Bureau of Standards.~~

"Two-speed idle test (TSI)" means a vehicle exhaust emissions test, performed in accordance with section (II) of 40 CFR Part 51, Appendix B to Subpart S, which measures the concentrations of pollutants in the exhaust gases of an engine (i) while the motor vehicle transmission is not propelling the vehicle and (ii) while the engine is operated at both curb idle and at a nominal engine speed of 2,500 rpm.

"Vehicle emissions index" means the ranking of probable emissions inspection failure-rates of affected motor vehicles. Values within the index are determined by calculating a percentile of the historical emissions inspection failure-rates of a specific engine family, and comparing that to the historical emissions inspection failure-rates of all engine families in a specific model year group. Motor vehicles with the highest percentage of failure rates have the highest ranking on the index. Failure rates are based on the two most recent calendar years of emissions inspection test data from the Virginia Motor Vehicle Emissions Control Program.

"Vehicle specific power (VSP)" means an indicator expressed as a function of vehicle speed, acceleration, drag coefficient, tire rolling resistance and roadway grade that is used to characterize the load a vehicle is operating under at the time and place a vehicle is measured by remote sensing equipment. It is calculated using the following formula:

$$\text{VSP} = 4.39 \times \text{Sine} (\text{Site Grade in Degrees}/57.3) \times \text{Speed} + \text{K1} \times \text{Speed} \times \text{Acceleration} + \text{K2} \times \text{Speed} + \text{K3} \times \text{Speed}^3.$$

Where:

VSP = vehicle specific power indicator;

Sine = the trigonometric function that for an acute angle is the ratio between the side opposite the angle when it is considered part of a right triangle and the hypotenuse;

Site Grade in Degrees = slope of road where remote sensing measurement is taken;

K1, K2 and K3 = empirically determined coefficients specific to the weight class of the vehicle;

Speed = rate of motion in miles per hour of vehicle at the time remote sensing measurement is taken; and

Acceleration = change in speed in miles per hour per second.

For light duty vehicles the values for K1, K2 and K3 are respectively 0.22, 0.0954 and 0.0000272. Based on EPA guidance, the department may develop different values for K1, K2 and K3 that are applicable to heavy duty vehicles or to specific classes of light duty vehicles.

"Virginia Motor Vehicle Emissions Control Program" means the program for the inspection and control of motor vehicle emissions established by Virginia Motor Vehicle Emissions Control Law.

"Virginia Motor Vehicle Emissions Control Law" means Article 22 (§ 46.2-1176 et seq.) of Chapter 10 of Title 46.2 of the Code of Virginia.

Regulations

"Visible smoke" means any air pollutant, other than visible water droplets, consisting of black, gray, blue or blue-black airborne particulate matter emanating from the exhaust system or crankcase. Visible smoke does not mean steam.

~~"Zero gas" means a gas, usually air or nitrogen, which is used as a reference for establishing or verifying the zero point of an exhaust gas analyzer.~~

Part II General Provisions

9VAC5-91-30. Applicability and authority of the department.

A. The provisions of this chapter, unless specified otherwise, apply to the following:

1. Any owner of an affected motor vehicle, including new motor vehicles, specified in subsection B of this section. References made to responsibilities or requirements applicable to an affected motor vehicle shall mean that the owner shall be responsible for compliance with all applicable provisions of this chapter.
2. Any owner of an emissions inspection station or fleet emissions inspection station under the auspices of the enhanced emissions inspection program. References made to responsibilities or requirements of emissions inspection stations or fleet emissions inspection stations shall mean that the owner, permittee or certificate holder, as appropriate, shall be responsible for compliance with all applicable provisions of this chapter.
3. Any person who conducts an emissions inspection under the auspices of the enhanced emissions inspection program.
4. Any owner of an emissions repair facility performing emissions repairs on motor vehicles affected by this chapter. References made to responsibilities or requirements of certified emissions repair facilities shall mean that the owner, permittee or certificate holder, as appropriate, shall be responsible for compliance with all applicable provisions of this chapter.
5. Any emissions repair technician performing emissions repairs on motor vehicles affected by this chapter.
6. Any on-road emissions inspector conducting on-road testing.
7. Any person or corporation that has entered into a contract with the director to provide services in accordance with this chapter.

B. The provisions of this chapter, unless specified otherwise, apply to the following affected motor vehicles:

1. Any affected motor vehicle, including new motor vehicles, registered by the Virginia Department of Motor Vehicles and garaged within the Northern Virginia program area.
2. Any affected motor vehicle, including new motor vehicles, registered by the Virginia Department of Motor

Vehicles and garaged outside of the Northern Virginia program area but operated primarily in the Northern Virginia program area.

3. Any affected motor vehicle, including new motor vehicles not registered by the Department of Motor Vehicles but operated primarily in the Northern Virginia program area.

4. Any affected motor vehicle, including new motor vehicles owned or operated as part of a fleet located outside the Northern Virginia program area but operated primarily in the Northern Virginia program area.

C. As provided in the Virginia Motor Vehicle Emissions Control Law, affected motor vehicles shall be submitted for biennial emissions inspections and shall be in compliance with this chapter.

1. Motor vehicles having obtained a valid enhanced emissions inspection pass from another program area or another state within the most recent 12 months may be determined by the director to be in compliance with the enhanced emissions inspection required by this chapter for initial registration in Virginia. The valid period for such emissions inspection shall be one year. The proof of emissions inspection results from an enhanced emissions inspection program shall be presented to the Department of Motor Vehicles in such cases. The vehicle and proof of compliance may be presented to the department for verification purposes in order to resolve questions or disputes. Such vehicles are subject to all other provisions of this chapter.

2. The director may temporarily defer the emissions inspection requirement for motor vehicles registered in but temporarily located outside the program area at the time of such requirement based on information including, but not limited to, the location of the vehicle, the reason for and length of its temporary location, and demonstration that it is not practical or reasonable to return the vehicle to the program area for inspection. All such information shall be provided by the owner and is subject to verification by the department.

3. Clean screen vehicles may be determined by the director to be in compliance with the enhanced emissions inspection required by this chapter.

D. Motor vehicles being titled for the first time shall be considered to have an enhanced emissions inspection valid for two years. Such vehicles are not exempt from the emissions inspection program and are subject to all other provisions of this chapter.

E. Pursuant to § 46.2-1180 B of the Motor Vehicle Emissions Control Law, motor vehicles of the current model year and the four immediately preceding model years, held for resale in a licensed motor vehicle dealer's inventory, may be registered for one year upon sale without obtaining an

emissions inspection in accordance with conditions enumerated below.

1. The vehicle must be registered in the program area.
2. The vehicle has not failed nor received a waiver during its most recent emissions inspection.
3. The vehicle has not previously been registered under the provisions of this subsection.
4. The motor vehicle dealer guarantees in writing to the customer and to the department that the emissions equipment on the motor vehicle is operating in compliance with the warranty of the manufacturer or distributor, or both if applicable, at the time of sale.

- a. The document supplied must describe the method by which this compliance was determined and provide a copy of any emissions readings obtained from the vehicle for the purpose of making this showing.

- b. The document must state in prominent or bold print that the certification in no way warrants or guarantees that the vehicle complied with the emission standards used in the Virginia enhanced emissions inspection program, or similar language approved by the department and that the customer has a right to request an emissions inspection, which may be at the expense of the customer, in lieu of the one year emissions validation period authorized by this subsection.

5. A written request, including the documentation cited above, must be presented to the department not more than 30 days prior to the date of sale so that the department can record such temporary emissions validation period and furnish it to the Department of Motor Vehicles.

6. Such temporary validation period shall not be granted more than once for any motor vehicle.

7. For the purposes of this subsection, any used motor vehicle will be considered to be one model year old on the first day of October of the next calendar year after the model year described on the vehicle title or registration, and shall increase in age by one year on the first day of each October thereafter.

F. Owners or operators of fleets, including fleets of government vehicles and sensitive mission vehicles, shall provide a report to the department annually containing information regarding vehicles operated in the program area sufficient to determine compliance with this chapter. The report shall contain information deemed necessary by the department to determine compliance. Such information shall include, but not be limited to, (i) number of vehicles, (ii) compliance method, and (iii) results of any inspections. Reports shall be in a format and according to a schedule acceptable to the department.

G. Manufacturers and distributors of emissions testing equipment are prohibited from directly or indirectly owning or operating any emissions testing facility or having any direct or indirect financial interest in any such facility other

than the leasing of or providing financing for equipment related to emissions testing.

H. The provisions of this chapter, unless specified otherwise, apply only to those pollutants for which emission standards are set forth in Part III (9VAC5-91-160 et seq.) and Part XIV (9VAC5-91-790 et seq.).

I. Applicants for inspection station permits and emissions repair facility certificates shall have a Virginia business license and the application shall only be for a facility in Virginia.

J. By the adoption of this chapter, the board confers upon the department the administrative, enforcement and decision making authority enumerated herein.

9VAC5-91-50. Documents incorporated by reference.

A. The Administrative Process Act and Virginia Register Act provide that state regulations may incorporate documents by reference. Throughout this chapter, documents of the types specified below have been incorporated by reference.

1. United States Code.
2. Code of Virginia.
3. Code of Federal Regulations.
4. Federal Register.
5. Technical and scientific reference documents.

Additional information on key federal regulations and nonstatutory documents incorporated by reference and their availability may be found in subsection E of this section.

B. Any reference in this chapter to any provision of the Code of Federal Regulations (CFR) shall be considered as the adoption by reference of that provision. The specific version of the provision adopted by reference shall be that contained in the latest revision to the CFR in effect on ~~July 1, 2001~~ July 1, 2012, unless noted otherwise. In making reference to the Code of Federal Regulations, 40 CFR Part 35 means Part 35 of Title 40 of the Code of Federal Regulations; 40 CFR 35.20 means § 35.20 in Part 35 of Title 40 of the Code of Federal Regulations.

C. Failure to include in this section any document referenced in this chapter shall not invalidate the applicability of the referenced document.

D. Copies of materials incorporated by reference in this section may be examined by the public at the central office of the Department of Environmental Quality, Air Division, Eighth Floor, 629 East Main Street, Richmond, Virginia, between 8:30 a.m. and 4:30 p.m. of each business day.

E. Information on federal regulations and nonstatutory documents incorporated by reference and their availability may be found below in this subsection.

1. Code of Federal Regulations.
 - a. The provisions specified below from the Code of Federal Regulations (CFR) are incorporated herein by reference:

Regulations

(1) 40 CFR Part 51 - Requirements for Preparation, Adoption and Submittal of Implementation Plans, specifically Subpart S (Inspection and Maintenance Program Requirements).

(2) 40 CFR Part 85 - Control of Air Pollution from Motor Vehicles and Motor Vehicle Engines, specifically Subpart W (Emission Control System Performance Warranty Short Tests).

b. Copies may be obtained from: Superintendent of Documents, U.S. Government Printing Office, Washington, D.C. 20402; phone (202) 783-3238.

2. Environmental Protection Agency, Motor Vehicle Emissions Laboratory.

a. The following document is incorporated herein by reference: Environmental Protection Agency technical report, "EPA Recommended Practice for Naming I/M Calibration Gas," EPA-AA-TSS-83-8-B, September 1983.

b. The following document is incorporated herein by reference: Environmental Protection Agency technical guidance, Acceleration Simulation Mode Test Procedures, Emission Standards, Quality Control Requirements, and Equipment Specifications," ~~EPA AA-RSPD-IM-96-2, July 1996~~ EPA420-B-04-011, July 2004.

c. Copies may be obtained from: Environmental Protection Agency, Office of Transportation and Air Quality, 2000 Traverwood, Ann Arbor, MI 48105.

3. Building Officials & Code Administrators International, Inc.

a. The following document is incorporated herein by reference: The BOCA National Mechanical Code/1993, Eighth Edition.

b. Copies may be obtained from: Building Officials & Code Administrators International, Inc., 4051 West Flossmoor Road, Country Club Hills, Illinois 60478-5795.

9VAC5-91-70. Appeal of case decisions.

A. Any owner, emissions inspector, emissions repair technician, or other party significantly affected by any action of the director or the department taken without a formal hearing may request a formal hearing in accordance with § 2.2-4020 of the Administrative Process Act, provided a formal hearing has not been waived and a petition requesting such formal hearing is filed with the director within 30 days after notice of the action is mailed, by postal or electronic delivery, or delivered to such owner, emissions inspector, emissions repair technician, or party requesting notification of such action.

B. In cases where the director or the department fails to make a case decision within the time frame specified by § 2.2-4021, the owner, emissions inspector, emissions repair

technician, or other party significantly affected, may provide written notice to the director that a decision is due in accordance with § 2.2-4021 of the Administrative Process Act. Appeals thereafter shall be in accordance with the Administrative Process Act.

C. Prior to any formal hearing, an informal fact finding shall be held pursuant to § 2.2-4019 of the Administrative Process Act, unless the named party and the director consent to waive the informal fact finding and go directly to a formal hearing.

D. Any decision of the director resulting from a formal hearing or from an informal fact finding wherein the parties have agreed to waive a formal hearing shall constitute the final decision for purposes of Article V (§ 2.2-4025 et seq.) of the Administrative Process Act.

E. Judicial review of any final decision shall be in accordance with Article V (§ 2.2-4025 et seq.) of the Administrative Process Act.

F. Nothing in this section shall prevent disposition of any case by consent.

G. Any petition for a formal hearing or any notice or petition for an appeal by itself shall not constitute a stay of decision or action.

~~9VAC5-91-200. Evaporative emissions systems standards. (Repealed.)~~

~~A. Standards for evaporative emissions inspections shall be those described in 9VAC5-91-450 for applicable motor vehicles.~~

~~B. Evaporative system fuel filler cap (gas cap) standards shall apply beginning January 5, 1998.~~

~~C. Evaporative system pressure testing standards shall apply provided such testing is mandated by the EPA for appropriate implementation plan credits. Such testing shall only be conducted at emissions inspection stations upon installation of approved equipment and software necessary for performing the test, as determined by the director.~~

9VAC5-91-330. Analyzer system operation.

Emissions inspection stations shall be equipped with a dynamometer and a functional analyzer system certified in accordance with Part X (9VAC5-91-640 et seq.) and maintained and operated in accordance with the following:

~~A. 1.~~ 1. Emissions inspection stations shall supply and maintain the analyzer a functional dynamometer in such a manner that will permit the proper operation in accordance with the requirements of the manufacturer, this chapter, applicable statutes, and any procedures developed by the department.

~~B. 2.~~ 2. The exhaust gas analyzer shall be gas spanned and leak checked according to 40 CFR Part 51, Appendix A to Subpart S or other procedure as approved by the department.

~~C.~~ 3. No additions or modifications shall be made to the analyzer system unless approved by the analyzer system manufacturer and the department.

~~1.~~ a. All repairs to the analyzer system must be performed by an authorized manufacturer representative according to 9VAC5-91-670 B and C or a program coordinator in accordance with 9VAC5-91-675 as applicable.

~~2.~~ b. No analyzer system replacement parts shall be used that are not original equipment replacement, or equivalent, as approved by the department.

~~D.~~ 4. No person shall tamper with or circumvent any system or function of the analyzer.

~~E.~~ 5. Emissions inspection stations shall be responsible for preventing any tampering with or unauthorized use of the dynamometer and the analyzer or ~~its~~ their functions.

~~F.~~ 6. Analyzer system lockout conditions shall be removed only by authorized service or department personnel.

~~G.~~ 7. The analyzer system shall be capable of electronically transmitting to and receiving data from the department computer network related to the administration of the Virginia Vehicle Emissions Control Program.

9VAC5-91-360. Inspector identification number and access code usage.

A. The department shall assign each emissions inspector a unique number and numerical code known as an inspector identification number and an access code to gain access to the analyzer system at the inspector's place of employment. Biometric identification may be used in place of an access code.

B. Access codes and identification numbers shall be added and deleted only by department personnel.

C. An inspector identification number and access code shall be used only by the inspector to whom it was assigned.

D. An inspector's name printed on a motor vehicle inspection report shall be an endorsement that the entire test was performed by the inspector whose name appears on the vehicle inspection report. Each inspector must sign his full name on the vehicle inspection report for each emission inspection conducted.

E. Emissions inspection stations and emissions inspectors shall report any unauthorized use of an inspector identification number or access code to the department within 24 hours of the discovery of unauthorized use.

F. Emissions inspection stations and inspectors shall be responsible for any violation or fraudulent inspection which occurs using inspector identification numbers or access codes.

G. Emissions inspection stations shall be responsible for all certificates of vehicle emissions inspection and motor vehicle inspection reports issued by that emissions inspection station.

9VAC5-91-390. Qualification requirements for emissions inspector licenses.

A. Applications to qualify for emissions inspector licenses shall be filed with the department and the issuance of the licenses shall be administered by the department. Applications for such licenses shall be completed on forms provided by the department. Before an applicant may be given a license, he must comply with the requirements of this section. The department will notify applicants of the evaluation requirements prior to testing.

B. An applicant shall demonstrate the ability to operate the certified analyzer systems properly and perform testing as required by this chapter.

C. No emissions inspector license shall be issued unless it is shown to the satisfaction of the director that the emissions inspector has the ability and resources to perform emissions inspections without causing a violation of the applicable provisions of this chapter and the Virginia Motor Vehicle Emissions Control Law.

D. Any applicant whose license has been revoked shall make a showing to the director that the condition causing the revocation has been corrected to the satisfaction of the director.

E. An applicant shall bear a valid motor vehicle driver's or operator's license and shall present proof of such license to the department at the time of application.

F. An applicant shall demonstrate knowledge, skill, and competence concerning the conduct of emissions inspections. Such knowledge, skill and competence shall be demonstrated by completing training courses approved by the department and by passing a qualification test (scoring 80% or higher) which may include, but not be limited to, knowledge of the following;

1. Operation and purpose of emissions control systems.
2. General relationship of hydrocarbon, oxides of nitrogen (NO_x), and carbon monoxide emissions to timing and air-to-fuel ratio control.
3. General information regarding adjustment and repair based on manufacturers' specifications.
4. This regulation (9VAC5-91-~~40 et seq.~~).
5. General information regarding contemporary diagnostic and engine tune-up procedures.
6. The provisions of the Emissions Control Systems Performance Warranty pursuant to § 207(b) of the federal Clean Air Act as it applies to this chapter.
7. Visual inspection of the required emissions control equipment for 1973 and newer vehicles.
8. Operation of and proper use, care, maintenance, and gas span checking of certified analyzer systems.
9. Proper use of and distribution of motor vehicle inspection reports, certificates of emissions inspection, and supplemental documents.

Regulations

10. Inspections for visible smoke emissions.

~~11. Functional testing of the evaporative emissions control system as required in the enhanced emissions inspection program.~~

~~12.~~ 11. Safety and public health as it applies to the Virginia Vehicle Emissions Control Program.

~~13.~~ 12. Public relations as it applies to the Virginia Vehicle Emissions Control Program.

9VAC5-91-410. General.

A. The key steps in the emissions inspection procedure are as follows:

1. Preliminary inspection of the vehicle to determine whether to accept the vehicle for testing or reject it, as approved by the department and according to 9VAC5-91-420 C. If the vehicle is rejected, the results of such preliminary inspection shall be provided to the customer.

2. Advise the customer of the ability of the emissions inspection station to perform emissions related repairs including the availability of certified emissions repair technicians and necessary equipment. If the vehicle failed the test, inform the customer of their right to seek repairs elsewhere.

3. An agreement between the customer and the emissions inspection station, oral or written, that an emissions inspection will be performed and the requisite fee paid.

4. Determination of the type of emissions test required, ASM or two-speed idle test, or OBD system test for OBD vehicles. For certain OBD vehicles, the director may require an exhaust test (ASM or two-speed idle) in addition to the OBD system test if he conducts appropriate studies and determines that (i) the expected failure rate for exhaust testing for these certain vehicles would be greater than 5.0%, (ii) additional emission reductions would be achieved, and (iii) the EPA acknowledges such emission reduction benefits.

5. The inspection of emissions control equipment and an evaluation for the presence of visible smoke.

6. The test of exhaust emissions levels, or the vehicle's on-board diagnostic system if applicable, using a certified analyzer system.

~~7. The evaporative system pressure test, if applicable, and fuel filler cap pressure test, as applicable according to the procedure determined automatically by the analyzer system.~~

8. 7. The distribution of documents and emissions inspection results. The emissions inspector shall sign each motor vehicle emissions inspection report for each emissions inspection performed by that inspector. The inspector's identification number or the inspector's signature, or both, shall be an endorsement that all aspects of the emissions inspection were performed by the inspector in accordance with this chapter.

~~9.~~ 8. Advise customers of emissions inspection results, options for waiver if applicable, and the obligation of the station to perform a free retest within 14 days for failed vehicles and the conditions placed on the motorist in regard to free retests.

~~10.~~ 9. Conduct free retest, if necessary, within 14 days of a chargeable initial test.

B. The emissions inspection station may charge a fee not to exceed the amount specified in § 46.2-1182 of the Code of Virginia.

9VAC5-91-420. Inspection procedure; rejection, pass, fail, waiver.

A. All aspects of the inspection shall be performed by an emissions inspector, using the instructions programmed in the certified analyzer system and procedures approved by the department, within the designated inspection area, and on the permitted premises.

B. The emissions inspection station shall notify the customer prior to initiating an emissions inspection that the emissions inspection station is either able or unable to perform the ~~emission-related~~ emissions-related repairs required by 9VAC5-91-480 for that particular vehicle should that vehicle fail the inspection. The emissions inspector shall not conduct an inspection on a motor vehicle unless the customer gives approval after being so notified.

C. The emissions inspector shall not conduct an inspection on a motor vehicle if the vehicle is in an unsafe condition for testing according to the following conditions. The customer shall be informed of any such condition.

1. The vehicle shall not have holes or detectable leaks in the exhaust system. The inspector may check the system for leaks by listening or visually inspecting for such leaks or by measuring carbon dioxide. The presence of leaks shall cause the vehicle to be rejected from testing.

2. The motor vehicle shall be evaluated for the presence of visible smoke emissions. Those vehicles exhibiting any visible smoke emissions from the engine crankcase or exhaust system or both, shall be rejected from testing.

3. The vehicle shall not have any mechanical problems, such as engine, brake, or transmission problems or engine, radiator, or transmission fluid leaks ~~which that~~ would create a safety hazard for the applicable test, or bias test results. Such conditions shall cause the vehicle to be rejected from testing.

4. For vehicles receiving a test while operating on a dynamometer, the vehicle shall be rejected from testing if drive wheel tire tread wear indicators, tire cords, bubbles, cuts, or other damage are visible. Such vehicles shall be rejected from testing if space-saver spare tires are being used on a drive axle or if they do not have reasonably sized tires on the drive axle or axles based on dynamometer manufacturer safety criteria or if the set of tires is a mixture of radial and bias ply. Vehicles may be rejected if

they have different sized tires on the drive axle or axles. Drive wheel tires shall be checked for appropriate tire pressure and adjusted as necessary as recommended by the tire or vehicle manufacturer.

5. The vehicle shall be rejected from testing if the fuel filler cap (gas cap) is missing ~~or cannot be removed~~.

6. The vehicle shall be rejected from testing if a known, emissions-related, manufacturers recall has not been satisfied according to Part XI (9VAC5-91-720 et seq.).

7. Vehicles that are overheated shall be rejected from testing. Vehicles that indicate that an overheated condition will be achieved during testing may be rejected from testing at the discretion of the inspector.

8. ~~Provided the OBD provisions of subdivision G 3 b of this section are being implemented,~~ OBD vehicles shall be rejected from testing for any of the following:

a. The OBD data link cannot be accessed physically or electronically.

b. The testing equipment indicates that the OBD system is in a "not ready" status. A "not ready" status shall be indicated by the following:

(1) For model year 1996 through 2000, three or more monitors indicate "not ready."

(2) For model year 2001 and newer, two or more monitors indicate "not ready."

(3) For vehicles that failed the emissions inspection for a catalytic converter related fault code, and the catalyst monitor indicates "not ready" during a reinspection.

~~c. The director, based on information discovered in this or other state programs or received from motor vehicle manufacturers or the EPA, may determine that a "not ready" status is indicated by more than the minimum number of monitors that indicate "not ready" as set forth in subdivision 8 b of this subsection. The catalyst monitor or oxygen sensor monitor, or both, are not supported, except for models exempt by the director.~~

d. The OBD system is unable to communicate successfully with the analyzer system.

e. The OBD system indicates evidence of tampering.

f. The director may adjust the number of "not ready" monitors required for rejection from testing for specific vehicle models based upon information from this program or other state programs, vehicle manufacturers, or the EPA.

D. The emissions inspection procedure shall be performed under the following conditions:

1. For vehicles subject to exhaust emissions testing, the entire vehicle shall be in normal operating condition as indicated by a temperature gauge or touch test on the radiator hose. If ASM testing is performed, a cooling fan shall be directed at the engine cooling system if the ambient temperature exceeds 72°F.

2. The inspection shall be performed with the transmission in park or neutral for OBD testing or for two-speed idle testing, or in drive (if automatic), or the appropriate gear to achieve necessary RPM range (if manual) for ASM testing; and with all accessories off.

3. All electronic and mechanical testing equipment shall be properly attached according to vehicle and analyzer system manufacturer requirements and instructions.

~~4. For the purpose of conducting the evaporative system pressure test, or gas cap pressure test, or both, the vehicle may be turned off unless the vehicle manufacturer has instructed otherwise.~~

~~5.~~ 4. For vehicles subject to exhaust emissions testing, the analyzer probe shall be properly inserted into the exhaust system.

a. The analyzer probe shall be inserted into the tailpipe as recommended by the gas analyzer manufacturer for a quality sample, or at least 10 inches if not specified by the manufacturer.

b. If a baffle or screen prevents probe insertion to an adequate depth, a suitable probe adapter or extension boot which effectively lengthens the tail pipe must be used.

c. If the vehicle is equipped with multiple unique exhaust outlets, a suitable analyzer system manufacturer recommended adapter or other apparatus shall be used in order to provide a single supply of the sample exhaust to the gas analyzer.

d. Vehicle exhaust shall be vented safely out of the inspection area and facility.

~~6.~~ 5. If the vehicle stops running or the engine stalls during the test it shall be started as soon as possible and, for vehicles subject to exhaust emissions testing, shall be running for at least 30 seconds prior to the restart of the test.

~~7.~~ 6. For vehicles subject to exhaust emissions testing, the exhaust test shall be terminated upon reaching the overall maximum test time for the applicable test, or if CO plus CO₂ concentration falls below 6.0% as determined by the analyzer system.

~~8.~~ 7. Each emissions inspection, whether initial or retest, shall be conducted in its entirety with the exception of: (i) conditions which require that the vehicle be rejected from testing in accordance with 9VAC5-91-420 subsection C of this section, (ii) invalid test conditions, or (iii) conditions beyond the emissions inspector's control that cause the test to be aborted.

E. In consideration of maintaining inspection integrity:

1. The temperature of the inspection area shall be between 41°F and 110°F during the inspection. Inspection area temperatures shall be accurately measured in a well-ventilated location away from vehicle engine and exhaust

Regulations

heat sources and out of direct sunlight. The analyzer system shall not be operated when the temperature of the inspection area is not within the range stated above.

2. The analyzer system shall be kept in a stable environment which affords adequate protection from the weather and local sources of hydrocarbons or other pollutants that may interfere with gas analyzer performance or accuracy of test results, or both.

3. The electrical supply to the analyzer system shall be able to meet the manufacturer's requirements for voltage and frequency stability.

4. The inspection location shall meet all applicable zoning requirements.

5. The analyzer system shall be operated according to quality assurance procedures and other procedures approved by the department.

F. The emissions inspector shall accurately identify and enter vehicle information, visual component and visible smoke inspection results as applicable for vehicle emissions inspection records. The data entered into the certified analyzer system and recorded on the certificate of vehicle emissions inspection shall be the data from the vehicle being inspected and must be obtained from that vehicle.

G. The emissions inspector shall perform an inspection of the emissions control systems. The inspection shall include the following:

1. An examination of the emissions control information decal (sticker) under the hood, reference manual, and applications guide to determine if the vehicle, as manufactured or certified for sale or use within the United States, should be equipped with a catalytic converter system, air injection system, fuel evaporative emissions control system, positive crankcase ventilation system, exhaust gas recirculation valve, on-board diagnostic system, or thermostatic air cleaner system, as appropriate.

2. Based on the determinations made in ~~9VAC5-91-420-G~~ subdivision 1 of this subsection, a visual inspection for the presence and operability of the catalytic converter system and, for vehicles subject to exhaust emissions testing, the air injection system, fuel evaporative emissions control system, positive crankcase ventilation system, exhaust gas recirculation system and thermostatic air cleaner system. If any of these parts or systems are inoperable, or have been removed or damaged, or rendered inoperable, the vehicle will not qualify for an emissions inspection approval or waiver. If systems are missing which the reference manual or applications guide indicates should be present, the motor vehicle manufacturer's emissions control information provided for that vehicle shall apply. The inspector shall enter the result of the visual inspection, "pass," "fail," or "not applicable" as appropriate into the certified analyzer system. The department may issue a temporary waiver because of the unavailability of component parts listed in

subdivision 2 of this subsection if it is determined that the subject components or parts are not available provided the following conditions have been met:

a. The owner of the vehicle obtains a signed statement from the manufacturer's dealer or automotive parts source that supplies parts for the vehicle model indicating the nonavailability of such parts.

b. The statement submitted must be on letterhead or other official form or document and signed by an officer, owner or other responsible official of the automotive parts source.

c. The statement must identify the parts by description and part number and must indicate whether the parts are not currently stocked, have been superseded by other parts, or are out of production.

d. The department may conduct an independent investigation to locate any such parts or to verify the information on the statement prior to the issuance of any vehicle inspection report. The vehicle shall be held to all applicable inspection parameters, test type and standards or other conditions with the exception of the emissions control components and parts that have been verified as unavailable.

e. Any additional requirements to repair the vehicle to meet the applicable emissions standards or to qualify for an emissions inspection waiver under ~~9VAC5-91-420-N~~ subsection M of this section shall apply.

f. If the department is able to determine that (i) the unavailable part, or parts, is the only method of controlling the emissions for which the vehicle has failed an emissions inspection or (ii) no other repairs will be effective in reducing such emissions, the department may issue a temporary waiver notwithstanding the provisions of ~~9VAC5-91-420-N~~ subsection M of this section.

3. For OBD vehicles, an electronic inspection of the applicable on-board diagnostic (OBD) system according to manufacturer specifications and procedures approved by the EPA. The exhaust emissions test may also be performed on a limited basis as specified by the department for quality control or program evaluation purposes.

~~a. Pending availability and installation of necessary hardware and software, emissions related results of sensing of OBD systems for OBD vehicles shall be recorded in the inspection record in addition to the exhaust emissions test procedures and reported to the customer. The OBD results shall not cause the vehicle to be rejected from testing or to fail the emissions inspection.~~

~~b. Beginning October 1, 2002, or a later date as determined by the department pending availability and installation of necessary hardware and software, emissions related~~ a. Emissions-related failure codes that

cause the malfunction indicator lamp to be commanded "on" provided by OBD systems of OBD vehicles shall cause the vehicle to fail the emissions inspection. If testing equipment or visual inspection indicates that the malfunction indicator lamp is inoperable, the vehicle shall fail the emissions inspection. If the testing equipment indicates that the OBD system is in a "not ready" status, the vehicle shall be rejected from testing according to ~~9VAC5-91-420 subdivision C 8 of this section.~~

~~e. Beginning October 1, 2004, emissions-related b. Emissions-related~~ failure codes that cause the malfunction indicator lamp to be commanded "on" as provided by OBD systems of light duty diesel powered vehicles of model years 1997 and newer shall cause the vehicle to fail the inspection. In addition, if the testing equipment or visual examination indicates that the malfunction indicator lamp is inoperable, the vehicle shall fail the emissions inspection. If the testing equipment indicates that the OBD system is in a "not ready" status, the vehicle shall be rejected from testing according to subdivision C 8 of this section. The director may increase or decrease the number of "not ready" monitors allowed based on an analysis of the program data, data from other state's programs and the EPA. ~~If the director finds that the necessary hardware and software necessary to perform this OBD test are not available or installed by October 1, 2004, the effective date shall be October 1, 2006.~~

~~d. c.~~ The department may exempt vehicle models or some classes of vehicles from OBD testing due to known OBD system problems or anomalies associated with such vehicles. If exempted from OBD testing, such vehicles shall receive the ASM or TSI test as applicable.

H. For vehicles otherwise subject to ASM testing based on model year and weight classification, the department may determine, due to complications identified in this or other state programs, or consultation with vehicle manufacturers, that certain vehicle makes or models shall be tested using the two-speed idle test in lieu of the ASM test or using a mixture of test modes such as an ASM 2525 coupled with an idle test.

I. For 1981 model year and newer vehicles with a GVWR up to and including 8,500 pounds, the exhaust emissions inspection procedure, if applicable, shall be an ASM, two-mode (ASM 5015 plus ASM 2525), loaded test, performed while the vehicle is operating on ~~the analyzer system~~ a dynamometer. The test shall be preceded by a 30-90 second preconditioning period, as determined by the department, using the ASM 2525 load simulation.

J. The exhaust emissions inspection procedure, if applicable, shall be a two-speed idle test as specified in section (II) of Appendix B of 40 CFR Part 51, Subpart S, and 9VAC5-91-440 for the following affected motor vehicles:

1. Vehicles with a GVWR greater than 8,500 pounds and up to and including 10,000 pounds;
2. Vehicles of model years 1980 and older;
3. Vehicles which employ full-time four wheel drive systems;
4. Vehicles which have traction control or anti-lock brake systems which have been determined by the manufacturer or the department to interfere with proper ASM testing; or
5. Vehicles which have some other configuration which has been determined by the department to interfere with proper ASM testing.

~~K. For vehicles originally factory equipped with an evaporative emissions control system, the vehicle's evaporative emissions control system shall be checked by performing an evaporative system pressure test, if applicable, and a fuel filler cap pressure test, as applicable according to the phase in of testing specified in 9VAC5-91-200.~~

~~L. K.~~ In order to obtain a vehicle registration from the Department of Motor Vehicles, a certificate of emissions inspection shall be issued by an emissions inspector or the department indicating that the vehicle has either passed the emissions inspection or has received a waiver as specified ~~below in subsections L and M of this section.~~ A motor vehicle shall pass the emissions inspection and a certificate of vehicle emissions inspection and a motor vehicle inspection report indicating the vehicle has passed shall be issued if the following conditions are met:

1. The motor vehicle meets the applicable emissions control systems inspection requirements.
2. For vehicles subject to exhaust emissions testing, the vehicle emissions levels are the same as or less than the applicable exhaust emission standards in Part III (9VAC5-91-160 et seq.) and Part XIV (9VAC5-91-790 et seq.), as applicable; or for vehicles subject to OBD, the vehicle passes the OBD test and exhaust emissions test, if applicable.
3. There are no visible smoke emissions from the vehicle engine crankcase or tail pipe, or both.
- ~~4. The vehicle passes the evaporative system pressure test, if applicable, and fuel filler cap pressure test.~~

~~M. L.~~ If the vehicle fails the initial emissions inspection, a certificate of emissions inspection and a motor vehicle inspection report shall be issued indicating a failure, and the owner shall have 14 days in which to have repairs or adjustments made and return the vehicle to the emissions inspection station which performed the initial inspection for one free reinspection.

~~N. M.~~ A certificate of vehicle emissions inspection waiver may be issued if all of the following conditions are met:

1. The vehicle passes the emissions control systems inspection described by subsection G of this section if applicable.

Regulations

2. There are no visible smoke emissions from the vehicle engine crankcase or exhaust system, or both.

~~3. The vehicle passes the evaporative system pressure test, if applicable, and fuel filler cap pressure test.~~

~~4.~~ 3. The vehicle continues to exceed applicable emissions standards after emissions related repairs required by 9VAC5-91-480 have been performed.

~~5.~~ 4. An amount equal to or greater than the adjusted waiver cost for enhanced emissions inspection programs specified in ~~subsection O~~ subsection N of this section has been spent on emissions related repairs as specified in 9VAC5-91-480 provided that:

a. Proof that emission related repairs have been accomplished and costs for that specific vehicle have been provided to the emissions inspection station in the form of an itemized bill, invoice, paid work order, or statement in which emissions related parts or repairs, or both, are specifically identified, and to the extent practical, the inspector can confirm the repairs by visual examination;

b. The emissions inspector has been provided with a properly completed emissions repair data form indicating that the repair work was performed at a certified emissions repair facility and that the repairs were performed by or under the supervision or approval of a certified emissions repair technician at a certified emissions repair facility; and

c. The repair work was performed no earlier than 60 days prior to the initial inspection.

~~O.~~ Beginning January 1, 2003, the N. The repair cost requirements for waiver eligibility for the enhanced emissions inspection program shall be \$450 adjusted to reflect the increase in the Consumer Price Index (CPI) and adjusted annually thereafter, as described at 40 CFR 51.360(a)(7) and § 46.2-1181 C of the Code of Virginia.

~~P.~~ O. A waiver shall not be issued for a vehicle which is eligible for the emissions control systems performance warranty, under the provisions of § 207(b) of the federal Clean Air Act. In accordance with the provisions of § 207(b) of the federal Clean Air Act, the repair costs necessary for compliance with emissions standards specified in Part III (9VAC5-91-160 et seq.) and Part XIV (9VAC5-91-790 et seq.) will be borne by the vehicle manufacturer or authorized dealer representative.

~~Q.~~ P. The analyzer system shall generate an electronic record of the certificate of emissions inspection and transmit the appropriate data to the department and the emissions inspector shall make distribution of the vehicle inspection report to the customer.

~~R.~~ Q. The customer shall be advised as specified below upon completion or termination of the inspection procedure.

1. If the test is terminated prior to completion, explain the problem with the vehicle or equipment and, if applicable, advise of free retest and time limit.

2. If the vehicle passes or receives a waiver, provide a motor vehicle inspection report and advise motorist of registration requirement and process, including the process to be used in case of interruption of the electronic data transfer system.

3. If the vehicle fails:

a. Give vehicle inspection report of failure to customer;

b. Advise of type of failure;

c. Advise of free retest and time limit;

d. Advise of repair facility information as provided by the department; and

e. Advise of waiver requirements, if applicable.

~~S.~~ R. In cases of complaints or disputes between the emissions inspector or emissions inspection station and the customer, the customer shall be advised of the location and phone number of a department representative to be contacted to obtain assistance in resolving disputes.

9VAC5-91-430. ASM test procedure.

A. The ASM equipment shall be in proper operating condition according to the manufacturer's instructions prior to initiating a test.

1. The vehicle shall be maneuvered onto the dynamometer with the drive wheels positioned on the dynamometer rolls. Prior to test initiation, the rolls shall be rotated until the vehicle laterally stabilizes on the dynamometer. Vehicles that cannot be stabilized on the dynamometer shall be rejected from testing. Drive wheel tires shall be dried if necessary to prevent slippage.

2. Prior to initiating the ASM exhaust test procedure:

a. Vehicles that are also required to receive OBD ~~or evaporative emissions~~ testing shall be connected to the appropriate test equipment ~~according to 9VAC5-91-450~~ and vehicle and analyzer system manufacturer instructions.

b. The OBD test, ~~evaporative system pressure test, if applicable, and fuel filler cap pressure test, including second chance fuel filler cap pressure test if required,~~ shall be performed prior to the ASM test.

3. When ambient temperatures exceed 72°F, testing shall not begin until the cooling fan is positioned and activated. The cooling fan shall be positioned to direct air to the vehicle cooling system, but shall not be directed at the catalytic converter.

4. Testing shall not begin until the vehicle is properly restrained for ASM testing.

5. Testing shall not begin until the exhaust ventilation system is properly functioning and attached or positioned as necessary.

6. To ensure that the motor vehicle and the dynamometer are in a warmed-up condition prior to official testing, a 30-90 second preconditioning, as determined by the department, shall be performed using the ASM 2525 load simulation.

7. Prior to each test or mode of a test, the analyzer system shall automatically select the load setting of the dynamometer.

8. Engine speed shall be monitored by means of an RPM sensor and recorded in the test record.

B. The test sequence shall consist of first chance and, if applicable, second chance tests in both ASM modes described in this section. Vehicles that fail the first chance test as described within 150% of the standard shall receive a second chance test. The department may increase this percentage to 200% when interim or final standards take effect according to 9VAC5-91-170 B. The second chance test shall consist of a repetition of the mode or modes that were failed in the first chance test. The department may eliminate the need to do a second chance test if the vehicle has already failed an emission component check.

C. The ASM 2525 mode timer shall start when the dynamometer speed (and corresponding power) are maintained at 25 ± 1.0 miles per hour for five continuous seconds. If the acceleration simulation exceeds the tolerance specified by the analyzer system equipment manufacturer for more than five consecutive seconds after the mode timer is started, the test mode timer shall be reset. Should this happen a third time, the test shall be aborted and another started. The dynamometer shall apply the required torque load for 25.0 mph at any testing speed within the tolerance of 25 ± 1.0 miles per hour (i.e., constant torque load over speed range). The torque tolerance shall be $\pm 5.0\%$ of the correct torque at 25 mph.

1. The analyzer system shall automatically select the proper load setting for the dynamometer and test standards, based on the Equivalent Test Weight (ETW) and the look-up table in Part XIV (9VAC5-91-790 et seq.), using vehicle identification information.

2. If the dynamometer speed or torque falls outside the speed or torque tolerance for more than two consecutive seconds, or for more than five seconds total, the test mode time shall reset to zero and resume timing. The minimum mode length shall be 45 seconds. The maximum mode length shall be 90 seconds elapsed time.

3. During the 10 second period used for the pass/fail decision, dynamometer speed shall not fall more than 0.5 mph (absolute drop, not cumulative). If the speed at the end of the 10 second period is more than 0.5 mph less than the speed at the start of the 10 second period, testing shall continue until the speed stabilizes enough to meet this criterion.

4. The pass/fail analysis shall begin after an elapsed time of 30 seconds, which may include up to 15 seconds of the preconditioning time period if the ASM 2525 torque and speed tolerances are maintained. A pass or fail determination shall be made for the vehicle and the mode shall be terminated as follows:

a. The vehicle shall pass the ASM 2525 mode and the mode shall be immediately terminated if, at any point between an elapsed time of 30 seconds and 90 seconds, the 10 second running average measured values for each pollutant are simultaneously less than or equal to the applicable test standards described in Part XIV (9VAC5-91-790 et seq.).

b. The vehicle shall fail the ASM 2525 mode and the mode shall be terminated if subdivision C 4 a of this section is not satisfied by an elapsed time of 90 seconds.

5. Upon termination of the ASM 2525 mode, the vehicle and dynamometer shall immediately begin a transition to the speed required for the ASM 5015 mode. The dynamometer torque shall smoothly transition during the transition period and shall automatically reset to the load required for the ASM 5015 mode as specified in subdivision D 1 of this ~~subsection~~ section.

D. The ASM 5015 mode timer shall start when the dynamometer speed (and corresponding power) are maintained at 15 ± 1.0 miles per hour for five continuous seconds. If the acceleration simulation exceeds the tolerance specified by the analyzer system manufacturer for more than five consecutive seconds after the mode timer is started, the test mode timer shall be reset. Should this happen a third time, the test shall be aborted and another started. The dynamometer shall apply the required torque for 15.0 mph at any testing speed within the tolerance of 15 ± 1.0 miles per hour (i.e., constant torque load over speed range). The torque tolerance shall be $\pm 5.0\%$ of the correct torque at 15 mph.

1. The analyzer system shall automatically select the proper load setting for the dynamometer and test standards, based on the ETW and the look-up table in Part XIV (9VAC5-91-790 et seq.), using vehicle identification information.

2. If the dynamometer speed or torque falls outside the speed or torque tolerance for more than two consecutive seconds, or for more than five seconds total, the mode timer shall reset to zero and resume timing. The minimum mode length shall be 40 seconds. The maximum mode length shall be 90 seconds elapsed time.

3. During the 10 second period used for the pass/fail decision, dynamometer speed shall not fall more than 0.5 mph (absolute drop, not cumulative). If the speed at the end of the 10 second period is more than 0.5 mph less than the speed at the start of the 10 second period, testing shall continue until the speed stabilizes enough to meet this criterion.

Regulations

4. The pass/fail analysis shall begin after an elapsed time of 30 seconds. A pass or fail determination shall be made for the vehicle and the mode shall be terminated as follows:

a. The vehicle shall pass the ASM 5015 mode if, at any point between an elapsed time of 30 seconds and 90 seconds, the 10-second running average measured values for each pollutant are simultaneously less than or equal to the applicable test standards described in Part XIV (9VAC5-91-790 et seq.). If the vehicle passed the ASM 2525 mode, the ASM 5015 mode shall be terminated upon obtaining passing scores for all three pollutants.

b. The vehicle shall fail the first chance ASM 5015 mode if subdivision D 4 a of this section is not satisfied by an elapsed time of 90 seconds.

E. The inspector shall perform a second chance test on vehicles which fail either mode of the previous test sequence as follows:

1. If the vehicle fails the first-chance test, the test timer shall reset to zero and a second-chance test shall be performed, except as noted below. The second-chance test shall have an overall maximum test time of 145 seconds if one mode is repeated, an overall maximum time of 290 seconds if two modes are repeated.

2. If the vehicle failed only the ASM 2525 mode of the first chance test, then that mode shall be repeated upon completion of the first chance ASM 5015 mode. The repeated mode shall be performed as described in this section except that the provisions of subdivision C 5 of this section shall be omitted.

3. If the vehicle failed only the ASM 5015 mode of the first chance test, then the first chance ASM 5015 mode shall not end at 90 seconds but shall continue for up to 180 seconds.

4. If the vehicle failed both ASM 5015 and ASM 2525 modes of the first chance test, then the vehicle shall receive a second-chance test for the ASM 2525 mode immediately following the first chance ASM 5015 mode. If the vehicle fails the second-chance ASM 2525 mode, then the vehicle shall fail the test, otherwise the vehicle shall also receive a second-chance ASM 5015 mode test.

9VAC5-91-440. Two-speed idle test procedure.

A. The emissions inspection procedure shall be a two-speed idle test as specified in section (II) of Appendix B of 40 CFR Part 51, Subpart S.

1. The two-speed idle test shall consist of a test of the vehicle's exhaust emissions at idle and at 2500 rpm while the vehicle's gear selector is in neutral or park.

2. The idle test shall be administered after the 2500 rpm test. The tests shall be run consecutively.

3. The complete test shall consist of a first chance 2500 RPM mode test; followed by a first chance idle mode test.

If either first chance mode fails, the first chance shall be followed by a preconditioning at 2500 RPM for up to three minutes and a second chance 2500 RPM mode test followed by a second chance idle mode. The department may eliminate the need to repeat a mode that passed the first chance test.

4. If the vehicle fails the first chance test, the second chance test and preconditioning shall be omitted if no exhaust hydrocarbon concentration less than 1800 ppm is detected within an elapsed time of 30 seconds. The department may eliminate the need to do a second chance test if the vehicle has already failed an emission component check.

5. Motor vehicle manufacturers and the Environmental Protection Agency may issue special test instructions for specific vehicle models which shall be followed in lieu of the test procedures specified in this section if such instructions are provided through the administrator.

6. In order to pass the two-speed idle test, the vehicle's exhaust shall not exceed the standards listed in 9VAC5-91-160.

~~7. Prior to initiating the two speed idle exhaust test procedure the following conditions shall be met:~~

~~a. 7. Vehicles which are required to receive OBD or evaporative emissions testing shall be connected to the appropriate test equipment according to 9VAC5-91-450 and vehicle and analyzer manufacturer instructions. b. The OBD test, evaporative system pressure test, if applicable, or fuel filler cap pressure test, including second chance fuel filler cap pressure test if required, shall be performed prior to the two-speed idle test.~~

B. The idle test mode shall be performed as follows:

1. The vehicle transmission shall be in neutral or park and the parking brake applied; the engine shall be operating at curb idle and there shall not be any manipulation of the engine throttle mechanism.

2. The engine speed (RPM) shall be obtained and shall be between 400 and 1250 RPM for the duration of the test mode.

3. The pass/fail analysis shall begin after an elapsed time of 10 seconds.

4. The idle mode elapsed time shall be 30 seconds.

5. The exhaust concentrations shall be measured as percent carbon monoxide and parts per million hydrocarbons after stabilized readings are obtained and averaged over the last five seconds at the end of the idle test mode.

C. The 2500 RPM test mode shall be performed as follows:

1. The vehicle transmission shall be in neutral or park.

2. The vehicle engine speed shall be increased from idle to between 2200 and 2800 RPM and maintained at that level.

3. If the engine speed varies outside the parameters of 2200 to 2800 RPM for more than two seconds during a sampling

period, the 2500 RPM mode shall be invalid and the 2500 RPM test shall be restarted. If the engine speed varies outside such parameters for more than a cumulative total of 10 seconds, the 2500 RPM test mode shall be invalid and another initiated.

4. The pass/fail analysis shall begin after an elapsed time of 10 seconds.
5. The 2500 RPM mode elapsed time shall be 30 seconds.
6. The exhaust concentrations shall be measured as percent carbon monoxide and parts per million hydrocarbons after stabilized readings are obtained and averaged over the last five seconds at the end of the 2500 RPM test mode.

9VAC5-91-450. Evaporative system pressure test and gas cap pressure test procedure. (Repealed.)

~~A. The evaporative system pressure test, if applicable, and fuel filler cap pressure test shall be performed according to the requirements of 40 CFR 51.357(a)(10) and (b)(3), or according to alternate procedures approved by the Environmental Protection Agency and approved by the department as part of a certified analyzer system.~~

~~B. The evaporative system pressure test shall be performed as follows:~~

- ~~1. The gas cap shall be removed and the appropriate adapter connected to the fuel filler inlet.~~
- ~~2. The gas cap shall be connected to an appropriate adapter, either as part of the adapter connected to the fuel filler inlet or as part of a separate gas cap pressure test rig.~~
- ~~3. The vapor hose or line in the fuel system connecting the evaporative canister to the fuel tank shall be clamped as close as possible to the canister. If the vapor line cannot be clamped to prevent vapor passage, it shall be disconnected from the canister and plugged to prevent vapor passage.~~
- ~~4. The fuel tank shall be pressurized with ambient air, or a suitable, equivalent gas, to a pressure of 14 inches, ± 0.5 inches, of water.~~
- ~~5. The flow shall be turned off and the decay of pressure monitored for up to two minutes.~~
- ~~6. If at any time during the two minutes the fuel tank vapor system is being monitored the pressure drops from the starting pressure by more than six inches of water, the test shall be terminated and the vehicle shall be determined to fail the evaporative system pressure test.~~
- ~~7. After two minutes, the clamp shall be removed from the vapor line or the line shall be unplugged and the system monitored for a drop in pressure. If a pressure drop is detected, and the fuel tank vapor system did not fail the conditions in step 6 above, the vehicle shall pass the evaporative system pressure test. If the gas cap is also connected to the fuel filler neck adapter during the evaporative system pressure test, then the vehicle shall also pass the gas cap pressure test.~~

~~8. If no pressure drop was detected after unclamping or unplugging the vapor line, the fuel tank, and cap if attached to the fuel inlet adapter, shall be pressurized to a pressure of 28 inches, ± 1.0 inches, of water, and steps 5, 6, and 7 above repeated.~~

~~9. At the termination of the test, the vapor hose and gas cap shall be reinstalled.~~

~~C. The gas cap pressure test shall be performed using the following procedures:~~

- ~~1. The gas cap shall be connected to an adapter on a separate gas cap pressure test rig and shall be pressurized to a pressure of 28 inches, ± 1.0 inches, of water.~~
- ~~2. The flow shall be turned off and the decay of pressure monitored for up to two minutes.~~
- ~~3. If at any time during the two minutes the gas cap pressure test rig is being monitored the pressure drops from the starting pressure by more than six inches of water, the test shall be terminated and the vehicle shall be determined to fail the evaporative system pressure test; otherwise the vehicle shall pass the gas cap pressure test.~~
- ~~4. Vehicles equipped with more than one functional fuel tank shall have all gas caps tested.~~

~~D. If the vehicle fails the gas cap pressure test, a new gas cap may be installed and a second chance gas cap pressure test performed. Any failure and subsequent pass under this second chance testing must be recorded as part of the emissions inspection and reported to the customer.~~

9VAC5-91-570. Expiration, reinstatement, renewal and requalification.

A. Upon expiration, suspension, or revocation of the certification, the emissions repair technician shall no longer be authorized to perform emissions related repairs and have them apply toward emissions inspection waivers as described in 9VAC5-91-420-N 9VAC5-91-420-M.

B. Certification of an emissions repair technician is required as a result of revocation or expiration of the certification.

C. The director shall reinstate certification of an emissions repair technician at the end of a suspension period upon notification by the emissions repair technician that the suspension period has ended.

D. Requalification may be required at any time by the department based on the results of monitoring of the performance of the emissions repair technician or based on changes in applicable vehicle emissions control or repair technology. Failure to requalify within three months of notification shall result in expiration of the emissions repair technician certification.

E. The department will endeavor to notify technicians prior to the expiration of their certification. However, it is the responsibility of the emissions repair technician to maintain a current certification.

Regulations

F. Upon expiration or notification of revocation or suspension, the technician shall surrender to the department all certification documents issued by the department.

G. Requalification requirements for all emissions repair technicians.

1. When necessary to update the technical qualifications of emissions repair technicians, or when technician performance monitoring indicates a need for additional training or other action, holders of emissions repair technician certifications shall be required to requalify.

2. Emissions repair technicians shall be required to requalify within 90 days from the date of written notification by the department. Notice of this requirement shall be mailed, by postal or electronic delivery, to the address of record as maintained by the department. The notice shall inform the person of the necessity of requalification and the nature of such skills, systems, and procedures requiring the training for the continued performance as an emissions repair technician. The notice shall give the name and location of training sources approved or accredited for purposes of retraining, the necessity of requalification by a certain date, and the nature and evidence of documentation to be filed with the department evidencing such requalification.

9VAC5-91-640. Applicability.

A. The provisions of this chapter apply to any system used for measuring or determining exhaust gases and evaporative emissions from motor vehicles in the Virginia Motor Vehicle Emissions Control Program.

B. No owner or other person shall conduct emissions inspections required by the Virginia Vehicle Emissions Control Program pursuant to this chapter unless the analyzer system used to perform such inspections is certified by the department and such other required equipment meets the provision of this chapter.

9VAC5-91-650. Design goals.

A. The analyzer system shall be designed for maximum operational simplicity with a minimum number of operational decisions required by the emissions inspector in the performance of a complete emissions analysis including exhaust tests, ~~evaporative system or fuel filler cap pressure tests~~, other emissions-related electronic or mechanical tests, or a combination of such tests.

B. The analyzer system shall be unaffected by ambient conditions in a typical emissions inspection station environment and its use shall be primarily for compliance inspection purposes. It shall be capable of providing emissions characteristics, independent of the inspection function, which can be used for vehicle diagnostic work as well.

C. The analyzer system shall be of a design which can perform both ASM and OBD testing using an analyzer certified under 9VAC5-91-680 with the addition of ~~(±) a dynamometer, (ii) a NO_x analyzer, (iii) evaporative system~~

~~pressure test equipment, (iv) fuel filler cap pressure test equipment, and (v) a two dimensional bar code reader and laser printer.~~

D. The analyzer shall be readily upgradable, without replacing the existing central processing unit, to incorporate on-board diagnostic (OBD) testing equipment and additional electronic vehicle identification equipment such as video and audio processes.

9VAC5-91-660. Warranty; service contract (effective during periods without a designated program coordinator).

A. A certified emissions analyzer system shall include, at a minimum, a one-year warranty, including parts and labor, which shall begin on the day that the emissions inspection station is permitted by the department, or that the emissions analyzer system is installed and operational, whichever is later. The disk drive system in the central processing unit shall be warranted for two years.

B. Emissions analyzer system manufacturers or vendors shall offer, at a price to be stated at the time such system is offered for sale, an extended warranty for an additional five years beyond the initial one-year warranty.

C. Emissions analyzer system manufacturers or vendors shall offer, at a price to be stated at the time such system is offered for sale, a maintenance service contract for the period of time remaining from the startup date to a date six years afterward.

9VAC5-91-665. Warranty; service contract with program coordinator.

A. On or after July 1, 2013, and upon designation of a program coordinator, a service contract approved by the department shall be established between each inspection station owner and the program coordinator providing, at a minimum, the following services:

1. The delivery, installation, calibration, and verification of the proper operating condition of an analyzer system that has been certified in writing by the department.

2. The instruction of all inspectors currently employed by the emissions inspection station at the time of installation to include but not be limited to:

a. The proper use, maintenance, and operation of the exhaust analyzer system;

b. The step-by-step procedure for performing an emissions inspection including OBD system test as appropriate;

c. The proper safety precautions for dynamometer use; and

d. The proper safety precautions for exhaust and calibration gas ventilation procedures.

B. The agreement shall provide for equipment maintenance and service or replacement of components of the certified analyzer system including dynamometer control devices,

optional analyzer equipment, and dynamometer preventative maintenance. Repair or replacement of analyzer system components, other than minimal maintenance items established in the service contract, must be performed by the program coordinator or his authorized agent.

C. The fee to be charged by the program coordinator for each certified analyzer system shall be determined by the department and shall not exceed \$3,500 per year, not including optional devices and services and minimal maintenance items established in the service contract.

D. The program coordinator may contract with the inspection station to provide services or equipment beyond the minimum requirements of the contract specified in subsection A of this section.

9VAC5-91-670. ~~Owner provided services.~~ Inspection station owner requirements (effective during periods without a designated program coordinator).

A. The owner of an emissions inspection station shall enter into an agreement with a manufacturer or its authorized representative to provide the following services to the emissions inspection station at an initial fixed cost per analyzer system to be agreed upon by both parties.

1. Delivery, installation, calibration, and verification of the proper operating condition of an analyzer system which has been certified in writing by the department.
2. Training of all inspectors employed by the emissions inspection station at the time of installation in (i) the proper use, maintenance, and operation of the exhaust analyzer system, (ii) the step-by-step procedure for performing an emissions inspection and any evaporative emissions control system test or fuel filler cap pressure test required, and (iii) proper safety precautions for dynamometer use and exhaust and calibration gas ventilation procedures.
3. Annual updates, except those to be performed by department personnel, of the preexisting internal computer software of the analyzer as specified by the department including, but not limited to:
 - a. Changes to the emissions standards;
 - b. Changes to the listed vehicle codes;
 - c. Changes to the items in the printing system to correspond to changes in other requirements; and
 - d. Additions or changes to the emissions control equipment list.

B. Emissions inspection stations shall maintain their analyzer systems and dynamometer in good working condition such that they continue to meet certification requirements. Any further arrangements regarding service or maintenance are at the discretion of the emissions inspection station and the manufacturer or equipment vendor.

C. Repair or replacement of analyzer system components, other than for normal maintenance, must be performed by the analyzer system manufacturer or authorized agent.

9VAC5-91-675. Inspection station owner requirements (effective during periods with a designated program coordinator).

A. On or after July 1, 2013, and upon notification of designation of a program coordinator, the owner of an emissions inspection station shall enter into an agreement with the program coordinator according to the requirements of 9VAC5-91-665.

B. The station shall provide minimal maintenance items established in the service contract with the program coordinator. The inspection station shall supply any printer paper and toner and gas analyzer probe tips if needed.

C. The station shall supply a safe and fully functional dynamometer at the time certified enhanced analyzer system equipment is provided by the program coordinator. The station shall provide preventative maintenance of the dynamometer until a service contract with a program coordinator is established. Any further arrangements regarding dynamometer service or maintenance are at the discretion of the emissions inspection station and the program coordinator.

9VAC5-91-680. Certification of analyzer systems.

A. No analyzer system may be installed, sold or represented as a certified enhanced analyzer system without prior written certification by the department.

B. The analyzer system must have a certificate from the manufacturer that it meets the specifications of 40 CFR Part 85, Subpart W. This certification is necessary so that inspections performed using that analyzer system will qualify applicable vehicles for warranty repair coverage according to the provisions of § 207(b) of the federal Clean Air Act.

C. A person requesting the certification of an emissions analyzer system for use in the Virginia Motor Vehicle Emissions Control Program shall make application to the department using procedures approved by the department.

D. The analyzer system, in order to become certified for use and be used for emissions inspections, shall conform to the equipment specifications and quality control requirements of EPA Technical Guidance document EPA AA RSPD IM 96-2 EPA420-B-04-011 (see 9VAC5-91-50) unless requirements contained therein are excluded or superseded by requirements of this chapter as enumerated below.

~~1. Vehicles powered by a fuel other than gasoline are not covered by ASM testing and references to emissions standards and correction factors to test such vehicles do not currently apply to ASM testing. (Ref. EPA AA RSPD IM 96-2, § 85.1(b)(1)(iv)).~~

~~2. The emissions inspection equipment is not required to incorporate vehicle brake sensing. (Ref. EPA AA RSPD IM 96-2, § 85.2(a)(5)).~~

~~3. 1. The preconditioning period for all vehicles undergoing an ASM test may be up to 90 seconds. System prompts regarding queuing time are unnecessary. (Ref.~~

Regulations

~~EPA AA RSPD IM 96-2~~ EPA420-B-04-011,
§ 85.2(b)(10)(i); ~~85.2(b)(11).~~

~~4. 2.~~ All OBD vehicles shall have engine RPM and emissions-related information read through the OBD connection ~~pending availability and installation of necessary hardware and software or January 1, 2003, whichever occurs last.~~ Emissions inspection equipment shall have the necessary equipment to perform such testing by this date, or as specified in 9VAC5-91-420-G-3. (Ref. ~~EPA AA RSPD IM 96-2, § 85.3(e)(5).~~)

~~5. 3.~~ Vehicles subject to ASM testing shall receive the ASM 2525 and ASM 5015 modes in that sequence, followed by any second chance testing for which the vehicle is eligible in the same sequence. Second chance tests shall only be performed on vehicles which failed the first chance test within the software specifications of all applicable standards. (Ref. ~~EPA AA RSPD IM 96-2 EPA420-B-04-011, § 85.2(d) and (e).~~ 85.2(e).)

~~6. 4.~~ Dynamometers shall be calibrated through a coast-down procedure every 72 hours. (Ref. ~~EPA AA RSPD IM 96-2 EPA420-B-04-011, § 85.4(b)(1).~~ 85.4(b)(1).)

~~7. Analyzer calibration gas bottles shall be bar coded or have bar coded labels providing the specifications of the gas contained within and the analyzer system shall require a reading of these specifications, through the system bar code reader, whenever the bottles are changed. The calibration gases, therefore, may have up to a 5.0% blend tolerance. (Ref. EPA AA RSPD IM 96-2, § 85.4(d)(2)(iv)).~~

~~8. Analyzer audit gas bottles shall be bar coded or have bar coded labels providing the specifications of the gas contained within and the analyzer system shall require a reading of these specifications, through the system bar code reader, whenever the audit is conducted. The calibration gases, therefore, may have up to a 5.0% blend tolerance. (Ref. EPA AA RSPD IM 96-2, § 85.4(d)(3)(iv)).~~

9VAC5-91-690. Span gases; gases for calibration purposes.

A. The gases used by emissions inspection stations in the emissions inspection shall be approved by the department and shall comply with the requirements of this section.

B. The gas concentrations, requirements, and tolerances of gases shall conform to the specifications contained in the EPA Technical Guidance document, ~~EPA AA RSPD IM 96-2 EPA420-B-04-011, July 2004~~ (see 9VAC5-91-50), and each container shall bear a bar-coded label containing concentration and tolerance information as required for calibration and audit purposes.

C. Gases shall be supplied in containers which meet all the provisions of the Occupational Safety and Health Administration as specified in 29 CFR 1910.101, Subpart H.

D. Gases shall be manufactured in accordance with the U.S. Environmental Protection Agency technical report, EPA-AA-TSS-83-8-B (see 9VAC5-91-50).

E. The station owner shall maintain a comprehensive, up-to-date list provided by the department, including addresses and phone numbers, of gas blenders approved by the department.

F. Each analyzer instrument shall be permanently labeled with its optical correction factor (also referred to as "C" factor, propane equivalency factor, or propane to hexane conversion factor), carried to at least two decimal places (within the gas accuracy limits), e.g., (0.52). Factor confirmation shall be made on each assembled analyzer by measuring both N-hexane and propane on assembly line quality checks.

9VAC5-91-700. Calibration of exhaust gas analyzers.

The department shall use, and require for use, gases and containers meeting the following parameters, blends, and specifications in the calibration of exhaust gas analyzers:

1. The calibration gases for standardizing instruments shall conform to the provisions outlined in ~~EPA AA RSPD IM 96-2 EPA420-B-04-011.~~

2. ~~Analyzers~~ Gas analyzers shall pass a two-point gas calibration for HC, CO, CO₂ and NO, within 72 hours before each test.

3. ~~Analyzers~~ Gas analyzers shall pass a five-point gas audit for HC, CO, CO₂, and NO at least two times within 12 months, and each time an analyzer system emissions measurement system, sensor, or other electronic components are repaired or replaced in response to an audit failure.

4. The director may reduce the frequency of calibrations in subdivision 2 of this section and audits in subdivision 3 of this section or both if evidence indicates accuracy would not be adversely affected.

9VAC5-91-710. Upgrade of analyzer system.

A. Any requirement to upgrade a certified emissions analyzer system beyond the specifications and requirements described in this chapter and ~~EPA AA RSPD IM 96-2 EPA420-B-04-011~~ shall apply to all such systems certified under this chapter and shall require an amendment to this chapter except for software or equipment upgrades provided under 9VAC5-91-670 or 9VAC5-91-675 as applicable.

B. Such upgrade may include, but not be limited to, enhanced on-board diagnostic (OBD) testing equipment, ~~any evaporative system pressure test,~~ and electronic vehicle identification systems such as video and audio processes.

Part XI

Manufacturer Recall

9VAC5-91-720. Vehicle manufacturer recall.

A. Motor vehicles subject to the enhanced emissions inspection program shall have any known emissions-related, vehicle manufacturer recall requirement satisfied prior to

testing, as feasible and practicable pending the availability of an emissions recall database, installation of necessary hardware and software, and on a schedule as determined by the director.

B. Manufacturers' emissions-related recall requirements may be pursuant to either a "Voluntary Emissions Recall" as defined at 40 CFR 85.1902(d) or to a remedial plan determination made pursuant to 42 USC § 7541(c).

C. The motor vehicle owner shall provide proof of compliance with such recall requirement to the emissions inspector or to the department.

1. Such proof shall consist of dated receipts from a motor vehicle dealer or repair facility authorized by the vehicle manufacturer to perform such repair or adjustment required by the recall.

2. The motor vehicle owner is responsible for obtaining satisfactory resolution of any such recall requirement and retaining all pertinent records and data.

D. Notification by mail, by postal or electronic delivery, to the motor vehicle owner of an emissions-related manufacturer recall at least 60 days prior to the requirement for an emissions inspection shall constitute adequate notice. Such notice may be provided through motor vehicle registration renewal notification, motor vehicle dealer notification, notification by the department, or other means.

DOCUMENTS INCORPORATED BY REFERENCE (9VAC5-91)

EPA Recommended Practice for Naming I/M Calibration Gas, EPA-AA-TSS-83-8-B, Environmental Protection Agency, September 1983

~~Acceleration Simulation Mode Test Procedures, Emission Standards, Quality Control Requirements and Equipment Specifications, EPA AA RSPD IM 96 2, Environmental Protection Agency, July 1996~~

[Acceleration Simulation Mode Test Procedures, Emission Standards, Quality Control Requirements and Equipment Specifications, EPA420-B-04-011, Environmental Protection Agency, July 2004](#)

The BOCA National Mechanical Code/1993, Eighth Edition, Building Officials & Code Administrators International, Inc.

VA.R. Doc. No. R13-3775; Filed July 10, 2013, 11:55 a.m.

DEPARTMENT OF ENVIRONMENTAL QUALITY

Final Regulation

Title of Regulation: **9VAC15-70. Small Renewable Energy Projects (Combustion) Permit by Rule (adding 9VAC15-70-10 through 9VAC15-70-140).**

Statutory Authority: § 10.1-1197.6 of the Code of Virginia.

Effective Date: August 28, 2013.

Agency Contact: Carol C. Wampler, Department of Environmental Quality, 629 East Main Street, P.O. Box 1105, Richmond, VA 23218, telephone (804) 698-4579, FAX (804) 698-4346, TTY (804) 698-4021, or email carol.wampler@deq.virginia.gov.

Summary:

This regulatory action establishes requirements for permits by rule for combustion energy projects with rated capacity not exceeding 20 megawatts, including requirements for potential environmental impacts analyses, mitigation plans, public participation, permit fees, interagency consultations, compliance, and enforcement. Changes since publication of the proposed regulation make technical corrections to 9VAC15-70-120 and 9VAC15-70-130 and delete the listing of documents incorporated by reference.

Summary of Public Comments and Agency's Response: A summary of comments made by the public and the agency's response may be obtained from the promulgating agency or viewed at the office of the Registrar of Regulations.

CHAPTER 70

SMALL RENEWABLE ENERGY PROJECTS
(COMBUSTION) PERMIT BY RULE

9VAC15-70-10. [Definitions Definitions]:

The following words and terms when used in this chapter shall have the following meanings unless the context clearly indicates otherwise:

"Applicant" means the owner or operator who submits an application to the department for a permit by rule pursuant to this chapter.

"Archive search" means a search of DHR's cultural resource inventory for the presence of previously recorded archaeological sites and for architectural structures and districts.

"Coastal Avian Protection Zones" or "CAPZ" means the areas designated on the map of "Coastal Avian Protection Zones" generated on the department's Coastal GEMS geospatial data system (9VAC15-70-120 C 1).

"Combustion energy project," or "project" means a small renewable energy project that:

1. Is an electrical generation facility with a rated capacity not exceeding 20 megawatts that generates electricity only from biomass, energy from waste, or municipal solid waste; and

2. Utilizes a fuel or feedstock that is addressed as a regulated solid waste by 9VAC20-81, 9VAC20-60, or 9VAC20-120; is defined as biomass pursuant to § 10.1-1308.1 of the Code of Virginia; or both.

"Department" means the Department of Environmental Quality, its director, or the director's designee.

"DCR" means the Department of Conservation and Recreation.

Regulations

"DGIF" means the Department of Game and Inland Fisheries.

"DHR" means the Department of Historic Resources.

"Disturbance zone" means the area within the site directly impacted by construction and operation of the combustion energy project.

"Historic resource" means any prehistoric or historic district, site, building, structure, object, or cultural landscape that is included or meets the criteria necessary for inclusion in the Virginia Landmarks Register pursuant to the authorities of § 10.1-2205 of the Code of Virginia and in accordance with 17VAC5-30-40 through 17VAC5-30-70.

"Interconnection point" means the point or points where the combustion energy project connects to a project substation for transmission to the electrical grid.

"Natural heritage resource" means the habitat of rare, threatened, or endangered plant and animal species, rare or state significant natural communities or geologic sites, and similar features of scientific interest benefiting the welfare of the citizens of the Commonwealth.

"Operator" means the person responsible for the overall operation and management of a combustion energy project.

"Owner" means the person who owns all or a portion of a combustion energy project.

"Parasitic load" means the maximum amount of electricity (in megawatts or kilowatts) a combustion energy project uses to run its electricity-producing processes while operating at the rated capacity.

"Parking lot" means an improved area, usually divided into individual spaces and covered with pavement or gravel, intended for the parking of motor vehicles.

"Permit by rule" means provisions of this chapter stating that a project or activity is deemed to have a permit if it meets the requirements of the provision.

"Person" means any individual, partnership, firm, association, joint venture, public or private corporation, trust, estate, commission, board, public or private institution, utility, cooperative, county, city, town, or other political subdivision of the Commonwealth, any interstate body, or any other legal entity.

"Preconstruction" means any time prior to commencing land-clearing operations necessary for the installation of energy-generating structures at the combustion energy project.

"Rated capacity" means the maximum designed electrical generation capacity (in megawatts or kilowatts) of a combustion energy project, minus the parasitic load; sometimes known as "net capacity."

"Site" means the area encompassed by the combustion energy project, plus appurtenant structures and facilities such as fuel processing, delivery, storage, and associated conveyance equipment areas if they (i) are contiguous and (ii)

primarily exist to supply fuel for the generation of electricity at that project, to the extent that these areas are under common ownership or operating control by the owner or operator of the combustion energy project.

"Small renewable energy project" means (i) an electrical generation facility with a rated capacity not exceeding 100 megawatts that generates electricity only from sunlight, wind, falling water, wave motion, tides, or geothermal power, or (ii) an electrical generation facility with a rated capacity not exceeding 20 megawatts that generates electricity only from biomass, energy from waste, or municipal solid waste.

"T&E," "state threatened or endangered species," or "state-listed species" means any wildlife species designated as a Virginia endangered or threatened species by DGIF pursuant to § 29.1-563-570 of the Code of Virginia and 4VAC15-20-130.

"VLR" means the Virginia Landmarks Register (9VAC15-70-120 B 1).

"VLR-eligible" means those historic resources that meet the criteria necessary for inclusion on the VLR pursuant to 17VAC5-30-40 through 17VAC5-30-70 but are not listed in the VLR.

"VLR-listed" means those historic resources that have been listed in the VLR in accordance with the criteria of 17VAC5-30-40 through 17VAC5-30-70.

"Wildlife" means wild animals; except, however, that T&E insect species shall only be addressed as part of natural heritage resources and shall not be considered T&E wildlife.

9VAC15-70-20. Authority and applicability.

A. This chapter is issued under authority of Article 5 (§ 10.1-1197.5 et seq.) of Chapter 11.1 of Title 10.1 of the Code of Virginia. The chapter contains requirements for combustion energy projects that are designed for, or capable of, operation at a rated capacity equal to or less than 20 megawatts.

B. The department has determined that a permit by rule is required for combustion energy projects with a rated capacity greater than five megawatts, provided that the projects do not otherwise meet the criteria for Part III (9VAC15-70-130 et seq.) of this chapter; and this regulation contains the permit by rule provisions for these projects in Part II (9VAC15-70-30 et seq.) of this chapter.

C. The department has determined that different provisions should apply to projects that meet the criteria as set forth in Part III (9VAC15-70-130) of this chapter, and this regulation contains the requirements, if any, for these projects in Part III (9VAC15-70-130) of this chapter. Projects that meet the criteria for Part III of this chapter are deemed to be covered by the permit by rule.

Part II

Permit by Rule Provisions for Combustion Energy Projects with Rated Capacity Greater Than Five Megawatts and Not Otherwise Meeting Criteria for Part III**9VAC15-70-30. Application.**

A. The owner or operator of a combustion energy project with a rated capacity greater than five megawatts, provided that the project does not otherwise meet the criteria for Part III (9VAC15-70-130) of this chapter, shall submit to the department a complete application in which he satisfactorily accomplishes all of the following:

1. In accordance with § 10.1-1197.6 B 1 of the Code of Virginia, and as early in the project development process as practicable, furnishes to the department a notice of intent, to be published in the Virginia Register of Regulations, that he intends to submit the necessary documentation for a permit by rule for a small renewable energy project;
2. In accordance with § 10.1-1197.6 B 2 of the Code of Virginia, furnishes to the department a certification by the governing body of the locality or localities wherein the small renewable energy project will be located that the project complies with all applicable land use ordinances;
3. In accordance with § 10.1-1197.6 B 3 of the Code of Virginia, furnishes to the department copies of all interconnection studies undertaken by the regional transmission organization or transmission owner, or both, on behalf of the small renewable energy project;
4. In accordance with § 10.1-1197.6 B 4 of the Code of Virginia, furnishes to the department a copy of the final interconnection agreement between the small renewable energy project and the regional transmission organization or transmission owner indicating that the connection of the small renewable energy project will not cause a reliability problem for the system. If the final agreement is not available, the most recent interconnection study shall be sufficient for the purposes of this section. When a final interconnection agreement is complete, it shall be provided to the department. The department shall forward a copy of the agreement or study to the State Corporation Commission;
5. In accordance with § 10.1-1197.6 B 5 of the Code of Virginia, furnishes to the department a certification signed by a professional engineer licensed in Virginia that the maximum generation capacity of the combustion energy project, as designed, does not exceed 20 megawatts;
6. In accordance with § 10.1-1197.6 B 6 of the Code of Virginia, furnishes to the department an analysis of potential environmental impacts of the small renewable energy project's operations on attainment of national ambient air quality standards;
7. In accordance with § 10.1-1197.6 B 7 of the Code of Virginia, furnishes to the department, where relevant, an

analysis of the beneficial and adverse impacts of the proposed project on natural resources. The owner or operator shall perform the analyses prescribed in 9VAC15-70-40. For wildlife, that analysis shall be based on information on the presence, activity, and migratory behavior of wildlife to be collected at the site for a period of time dictated by the site conditions and biology of the wildlife being studied, not exceeding 12 months;

8. In accordance with § 10.1-1197.6 B 8 of the Code of Virginia, furnishes to the department a mitigation plan pursuant to 9VAC15-70-70 that details reasonable actions to be taken by the owner or operator to avoid, minimize, or otherwise mitigate such impacts, and to measure the efficacy of those actions; provided, however, that the provisions of subdivision A 8 of this section shall only be required if the department determines pursuant to 9VAC15-70-50 that the information collected pursuant to § 10.1-1197.6 B 7 of the Code of Virginia and 9VAC15-70-40 indicates that significant adverse impacts to wildlife or historic resources are likely;

9. In accordance with § 10.1-1197.6 B 9 of the Code of Virginia, furnishes to the department a certification signed by a professional engineer licensed in Virginia that the project is designed in accordance with 9VAC15-70-80;

10. In accordance with § 10.1-1197.6 B 10 of the Code of Virginia, furnishes to the department an operating plan describing how any standards established in this chapter applicable to the permit by rule will be achieved;

11. In accordance with § 10.1-1197.6 B 11 of the Code of Virginia, furnishes to the department a detailed site plan meeting the requirements of 9VAC15-70-70;

12. In accordance with § 10.1-1197.6 B 12 of the Code of Virginia, furnishes to the department a certification signed by the applicant that the combustion energy project has applied for or obtained all necessary environmental permits;

13. Prior to authorization of the project and in accordance with §§ 10.1-1197.6 B 13 and 10.1-1197.6 B 14 of the Code of Virginia, conducts a 30-day public review and comment period and holds a public meeting pursuant to 9VAC15-70-90. The public meeting shall be held in the locality or, if the project is located in more than one locality, in a place proximate to the location of the proposed project. Following the public meeting and public comment period, the applicant shall prepare a report summarizing the issues raised by the public and include any written comments received and the applicant's response to those comments. The report shall be provided to the department as part of this application; and

14. In accordance with 9VAC15-70-110, furnishes to the department the appropriate fee.

B. Within 90 days of receiving all of the required documents and fees listed in subsection A of this section, the department

Regulations

shall determine, after consultation with other agencies in the Secretariat of Natural Resources, whether the application is complete and whether it adequately meets the requirements of this chapter, pursuant to § 10.1-1197.7 A of the Code of Virginia.

1. If the department determines that the application meets the requirements of this chapter, then the department shall notify the applicant in writing that he is authorized to construct and operate a combustion energy project pursuant to this chapter.
2. If the department determines that the application does not meet the requirements of this chapter, then the department shall notify the applicant in writing and specify the deficiencies.
3. If the applicant chooses to correct deficiencies in a previously submitted application, the department shall follow the procedures of this subsection and notify the applicant whether the revised application meets the requirements of this chapter within 60 days of receiving the revised application.
4. Any case decision by the department pursuant to this subsection shall be subject to the process and appeal provisions of the Administrative Process Act (§ 2.2-4000 et seq. of the Code of Virginia).

9VAC15-70-40. Analysis of the beneficial and adverse impacts on natural resources.

A. Analyses of wildlife. To fulfill the requirements of § 10.1-1197.6 B 7 of the Code of Virginia, the applicant shall conduct preconstruction wildlife analyses. The analyses of wildlife shall include the following if the disturbance zone exceeds 10 acres and the project does not meet the criteria of 9VAC15-70-130 B 2 a (2):

1. The applicant shall obtain a wildlife report and map generated from DGIF's Virginia Fish and Wildlife Information Service web-based application (9VAC15-70-120 C 3) or from a data and mapping system including the most recent data available from DGIF's subscriber-based Wildlife Environmental Review Map Service of the following: (i) T&E species within the project's disturbance zone; (ii) known wildlife species and habitat features within the project's disturbance zone and within two miles of the boundary of the project's disturbance zone; and (iii) known or potential sea turtle nesting beaches located within one-half mile of the disturbance zone.
2. If the height of the tallest point of the built structures exceeds 200 feet, the applicant shall consult the "Coastal Avian Protection Zones (CAPZ)" map generated on the department's Coastal GEMS geospatial data system (9VAC15-70-120 C 1) and determine whether the proposed combustion energy project disturbance zone will be located in part or in whole within one or more CAPZ.

B. Analyses of historic resources. To fulfill the requirements of § 10.1-1197.6 B 7 of the Code of Virginia, the applicant

shall also conduct a preconstruction historic resources analysis.

1. Desktop survey for projects with rated capacity exceeding five megawatts. The applicant shall perform a desktop survey of known VLR-listed and VLR-eligible historic resources within the project's disturbance zone and within one-half mile of the disturbance zone boundary by means of an archives search of DHR's cultural resource inventory and report in writing the results of the archives search to the department.
2. Architectural (direct impacts) and archaeological surveys if disturbance zone exceeds 10 acres. If the project's disturbance zone exceeds 10 acres and the project does not meet the criteria for 9VAC15-70-130 B 2 a (2), the applicant shall also meet the requirements of this subsection and the prescribed analysis shall be conducted by a qualified professional meeting the professional qualification standards of the Secretary of the Interior's Standards for Archaeology and Historic Preservation (9VAC15-70-120 B 2) in the appropriate discipline. The analysis for this subsection shall include each of the following:

- a. Architectural survey (direct impacts). The applicant shall conduct a field survey of all architectural resources, including cultural landscapes, 50 years of age or older, within the disturbance zone and evaluate the eligibility of any identified resource for listing in the VLR.
- b. Archaeological survey. The applicant shall conduct an archaeological field survey of the disturbance zone and evaluate the eligibility of any identified archaeological site for listing in the VLR. As an alternative to performing this archaeological survey, the applicant may make a demonstration to the department that the project will not penetrate the subsurface in a manner that would threaten archaeological resources and that any necessary grading of the site prior to construction does not have the potential to adversely impact any archaeological resource.

3. Architectural survey (indirect impacts) if the tallest point of the built structures exceeds 200 feet. If the tallest point of the built structures exceeds 200 feet, the applicant shall also conduct a field survey of all architectural resources, including cultural landscapes, 50 years of age or older, within the one-half mile of the disturbance zone boundary and evaluate the eligibility of any identified resource for listing in the VLR. The prescribed analysis shall be conducted by a qualified professional meeting the professional qualification standards of the Secretary of the Interior's Standards for Archeology and Historic Preservation (9VAC15-70-120 B 2) in the appropriate discipline.

4. Architectural survey (direct impacts) of structures 50 years of age or older. If the project will utilize or demolish existing buildings 50 years of age or older and the project

does not meet the criteria for 9VAC15-70-130 B 2 c (2), the applicant shall evaluate the eligibility of any such buildings for listing in the VLR. The prescribed analysis shall be conducted by a qualified professional meeting the professional qualification standards of the Secretary of the Interior's Standards for Archaeology and Historic Preservation (9VAC15-70-120 B 2) in the appropriate discipline.

C. Analyses of other natural resources. To fulfill the requirements of § 10.1-1197.6 B 7 of the Code of Virginia, and if the project's disturbance zone exceeds 10 acres, the applicant shall also conduct a pre-construction desktop survey of natural heritage resources within the disturbance zone.

D. Summary report. The applicant shall provide to the department a report presenting the findings of the applicable studies and analyses conducted pursuant to subsections A, B, and C of this section, along with all data and supporting documents. The applicant shall assess and describe the expected beneficial and adverse impacts, if any, of the proposed project on wildlife and historic resources identified by these studies and analyses.

9VAC15-70-50. Determination of likely significant adverse impacts for combustion energy projects with rated capacity greater than five megawatts.

A. The department shall find that significant adverse impacts to wildlife are likely whenever the wildlife analyses prescribed in 9VAC15-70-40 A document that any of the following conditions exists:

1. State-listed T&E wildlife are found to occur within the disturbance zone;
2. The disturbance zone is located on or within one-half mile of a known or potential sea turtle nesting beach; or
3. The disturbance zone is located in part or in whole within [zones zone] 1, 2, 3, 4, 5, 10, 11, 12, or 14 on the Coastal Avian Protection Zones (CAPZ) map and the height of the tallest point of the built structures exceeds 200 feet.

B. The department shall find that significant adverse impacts to historic resources are likely whenever the historic resources analyses prescribed by 9VAC15-70-40 B indicate that the proposed project is likely to diminish significantly any aspect of a historic resource's integrity.

9VAC15-70-60. Mitigation plan.

A. If the department determines that significant adverse impacts to wildlife or historic resources or both are likely, then the applicant shall prepare a mitigation plan. The mitigation plan shall include a description of the affected wildlife or historic resources, or both, and the impact to be mitigated; a description of actions that will be taken to avoid the stated impact; and a plan for implementation. If the impact cannot reasonably be avoided, the plan shall include a description of actions that will be taken to minimize the stated impact and a plan for implementation. If neither avoidance

nor minimization is reasonably practicable, the plan shall include a description of other measures that may be taken to offset the stated impact and a plan for implementation.

B. Mitigation measures for significant adverse impacts to wildlife shall include:

1. For state-listed T&E wildlife, the applicant shall take all reasonable measures to avoid significant adverse impacts or shall demonstrate in the mitigation plan what significant adverse impacts cannot practicably be avoided and why additional proposed actions are reasonable. These additional proposed actions may include best practices to avoid, minimize, or offset adverse impacts to resources analyzed pursuant to 9VAC15-70-40 A or C.

2. For proposed projects where the disturbance zone is located on or within one-half mile of a known or potential sea turtle nesting beach, the applicant shall take all reasonable measures to avoid significant adverse impacts or shall demonstrate in the mitigation plan what significant adverse impacts cannot practicably be avoided and why additional proposed mitigation actions are reasonable. Mitigation measures shall include the following:

- a. Avoiding construction within likely sea turtle crawl or nesting habitats during the turtle nesting and hatching season (May 20 - October 31). If avoiding construction during this period is not possible, then conducting daily crawl surveys of the disturbance zone (May 20 - August 31) and one mile beyond the northern and southern reaches of the disturbance zone (hereinafter "sea turtle nest survey zone") between sunrise and 9 a.m. by qualified individuals who have the ability to distinguish accurately between nesting and non-nesting emergences.
- b. If construction is scheduled during the nesting season, then including measures to protect nests and hatchlings found within the sea turtle nest survey zone.
- c. Minimizing nighttime construction during the nesting season and designing project lighting during the construction and operational phases to minimize impacts on nesting sea turtles and hatchlings.

3. For projects located in part or in whole within [zones zone] 1, 2, 3, 4, 5, 10, 11, 12, or 14 on the Coastal Avian Protection Zones (CAPZ) map for which the tallest point of the built structures exceeds 200 feet, contribute \$1,000.00 per megawatt of rated capacity, or partial megawatt thereof, to a fund designated by the department in support of scientific research investigating the impacts of projects in CAPZ on avian resources.

C. Mitigation measures for significant adverse impacts to historic resources shall include:

1. Significant adverse impacts to VLR-eligible or VLR-listed architectural resources shall be minimized, to the extent practicable, through design of the combustion energy project or the installation of vegetative or other screening.

Regulations

2. If significant adverse impacts to VLR-eligible or VLR-listed architectural resources cannot be avoided or minimized such that impacts are no longer significantly adverse, then the applicant shall develop a reasonable and proportionate mitigation plan that offsets the significantly adverse impacts and has a demonstrable public benefit and benefit for the affected or similar resource.

3. If any identified VLR-eligible or VLR-listed archaeological site cannot be avoided or minimized to such a degree as to avoid a significant adverse impact, significant adverse impacts of the project will be mitigated through archaeological data recovery.

9VAC15-70-70. Site plan and context map requirements.

A. The applicant shall submit a site plan that includes maps showing the physical features, topography, and land cover of the area within the site, both before and after construction of the proposed project. The site plan shall be submitted at a scale sufficient to show and shall include the following: (i) the boundaries of the site; (ii) the location, height, and approximate dimensions of all existing and proposed infrastructure; (iii) the location, grades, and dimensions of all temporary and permanent on-site and access roads from the nearest county or state maintained road; and (iv) water bodies, waterways, wetlands, and drainage channels.

B. If the project's disturbance zone exceeds 10 acres, the applicant shall submit a context map including the area encompassed by the site and within two miles of the site boundary. The context map shall show known state and federal resource lands and other protected areas, Coastal Avian Protection Zones, state roads, waterways, locality boundaries, forests, and open spaces.

9VAC15-70-80. Combustion energy project design standards.

The design and installation of the combustion energy project shall incorporate any requirements of the mitigation plan that pertain to design and installation, if a mitigation plan is required pursuant to 9VAC15-70-50.

9VAC15-70-90. Public participation.

A. Before the initiation of any construction at the combustion energy project, the applicant shall comply with this section. The owner or operator shall first publish a notice once a week for two consecutive weeks in a major local newspaper of general circulation informing the public that he intends to construct and operate a project eligible for a permit by rule. No later than the date of newspaper publication of the initial notice, the owner or operator shall submit to the department a copy of the notice along with electronic copies of all documents that the applicant plans to submit in support of the application. The notice shall include:

1. A brief description of the proposed project and its location, including the approximate dimensions of the site, approximate number and configuration of systems, and approximate maximum height of systems;

2. A statement that the purpose of the public participation is to acquaint the public with the technical aspects of the proposed project and how the standards and the requirements of this chapter will be met, to identify issues of concern, to facilitate communication, and to establish a dialogue between the owner or operator and persons who may be affected by the project;

3. Announcement of a 30-day comment period in accordance with subsection C of this section and the name, telephone number, address, and email address of the applicant who can be contacted by the interested persons to answer questions or to whom comments shall be sent;

4. Announcement of the date, time, and place for a public meeting held in accordance with subsection D of this section; and

5. Location where copies of the documentation to be submitted to the department in support of the permit by rule application will be available for inspection.

B. The owner or operator shall place a copy of the documentation in a location accessible to the public during business hours for the duration of the 30-day comment period in the vicinity of the proposed project.

C. The public shall be provided at least 30 days to comment on the technical and the regulatory aspects of the proposal. The comment period shall begin no sooner than 15 days after the applicant initially publishes the notice in the local newspaper.

D. The applicant shall hold a public meeting not earlier than 15 days after the beginning of the 30-day public comment period and no later than seven days before the close of the 30-day comment period. The meeting shall be held in the locality or, if the project is located in more than one locality, in a place proximate to the location of the proposed project.

E. For purposes of this chapter, the applicant and any interested party who submits written comments on the proposal to the applicant during the public comment period or who signs in and provides oral comments at the public meeting shall be deemed to have participated in the proceeding for a permit by rule under this chapter and pursuant to § 10.1-1197.7 B of the Code of Virginia.

9VAC15-70-100. Change of ownership, project modifications, termination.

A. Change of ownership. A permit by rule may be transferred to a new owner or operator if:

1. The department receives notification of the change of ownership within 30 days of the transfer; and

2. The notice includes written agreement by the new owner or operator to comply with all requirements of the existing permit by rule and the date on which permit responsibility is transferred to the new owner or operator.

B. Project modifications. Projects subject to Part II of this chapter may be modified as follows:

1. Project modifications that do not increase the project's disturbance zone by more than an additional 10 acres, cause the tallest point of the built structures to exceed 200 feet, or newly involve utilizing or demolishing a building over 50 years of age may occur without notice to the department. No fee will be levied for these modifications.

2. If, however, the project modification involves increasing the disturbance zone by more than 10 additional acres, increasing the height of the tallest point of the built structures so that it now exceeds 200 feet, or newly utilizing or demolishing a building over 50 years of age, the owner or operator shall furnish to the department new certificates prepared by a professional engineer, new documentation required under 9VAC15-70-30, and the appropriate fee in accordance with 9VAC15-70-110. The department shall review the received modification submittal pursuant to this subsection in accordance with the provisions of subsection B of 9VAC15-70-30.

C. Permit by rule termination. The department may terminate the permit by rule whenever the department finds that:

1. The applicant has knowingly or willfully misrepresented or failed to disclose a material fact in any report or certification required under this chapter; or

2. After the department has taken enforcement actions pursuant to 9VAC15-70-140, the owner or operator persistently operates the project in significant violation of the project's mitigation plan.

Prior to terminating a permit by rule pursuant to subdivision 1 or 2 of this subsection, the department shall hold an informal fact-finding proceeding pursuant to § 2.2-4019 of the Virginia Administrative Process Act in order to assess whether to continue with termination of the permit by rule or to issue any other appropriate order. If the department determines that it should continue with the termination of the permit by rule, the department shall hold a formal hearing pursuant to § 2.2-4020 of the Virginia Administrative Process Act. Notice of the formal hearing shall be delivered to the owner or operator. Any owner or operator whose permit by rule is terminated by the department shall cease operating his combustion energy project.

9VAC15-70-110. Fees for projects subject to Part II of this chapter.

A. Purpose. The purpose of this section is to establish schedules and procedures pertaining to the payment and collection of fees from any applicant seeking a new permit by rule or a modification to an existing permit by rule for a combustion energy project subject to Part II (9VAC15-70-30 et seq.) of this chapter.

B. Permit fee payment and deposit. Fees for permit by rule applications or modifications shall be paid by the applicant as follows:

1. Due date. All permit application fees or modification fees are due on submittal day of the application or modification package.

2. Method of payment. Fees shall be paid by check, draft, or postal money order made payable to "Treasurer of Virginia/DEQ" and shall be sent to the Department of Environmental Quality, Receipts Control, P.O. Box 1104, Richmond, VA 23218.

3. Incomplete payments. All incomplete payments shall be deemed nonpayments.

4. Late payment. No application or modification submittal will be deemed complete until the department receives proper payment.

C. Fee schedules. Each application for a permit by rule and each application for a modification of a permit by rule is a separate action and shall be assessed a separate fee, except as noted in 9VAC15-70-100 B 1. The amount of the permit application fee is based on the costs associated with the permitting program required by this chapter. The fee schedules are shown in the following table:

<u>Type of Action</u>	<u>Fee</u>
<u>Permit by rule application</u>	<u>\$8,000</u>
<u>Permit by rule modification</u>	<u>\$4,000</u>

D. Use of fees. Fees are assessed for the purpose of defraying the department's costs of administering and enforcing the provisions of this chapter including, but not limited to, permit by rule processing, permit by rule modification processing, and inspection and monitoring of combustion energy projects to ensure compliance with this chapter. Fees collected pursuant to this section shall be used for the administrative and enforcement purposes specified in this section and in § 10.1-1197.6 E of the Code of Virginia.

E. Fund. The fees received by the department in accordance with this chapter shall be deposited in the Small Renewable Energy Project Fee Fund.

F. Periodic review of fees. Beginning July 1, 2014, and periodically thereafter, the department shall review the schedule of fees established pursuant to this section to ensure that the total fees collected are sufficient to cover 100% of the department's direct costs associated with use of the fees.

9VAC15-70-120. Internet accessible resources.

A. This chapter refers to resources to be used by applicants in gathering information to be submitted to the department. These resources are available through the Internet; therefore, in order to assist applicants, the uniform resource locator or Internet address is provided for each of the references listed in this section.

B. Internet available resources.

1. The Virginia Landmarks Register, Virginia Department of Historic Resources, 2801 Kensington Avenue,

Regulations

Richmond, Virginia. Available at the following Internet address: <http://www.dhr.virginia.gov/register/register.htm>.

2. Professional Qualifications Standards, the Secretary of the Interior's Standards and Guidelines for Archeology and Historic Preservation, as amended and annotated (48 FR 44716-740, September 29, 1983), National Parks Service, Washington, DC. Available at the following Internet address: http://www.nps.gov/history/local-law/arch_stnds_9.htm.

3. The Natural Communities of Virginia, Classification of Ecological Community Groups, [~~Second Approximation, Version 2.3,~~] Virginia Department of Conservation and Recreation, Division of Natural Heritage, Richmond, VA. Available at the following Internet address: http://www.dcr.virginia.gov/natural_heritage/ncintro.shtml.

4. Virginia's Comprehensive Wildlife Conservation Strategy, 2005 (referred to as the Virginia Wildlife Action Plan), Virginia Department of Game and Inland Fisheries, 4010 West Broad Street, Richmond, Virginia. Available at the following Internet address: <http://www.bewildvirginia.org/wildlifeplan/>.

C. Internet applications.

1. Coastal GEMS application, 2010, Virginia Department of Environmental Quality. Available at the following Internet address: [<http://www.deq.virginia.gov/coastal/coastalgems.html> <http://www.deq.virginia.gov/Programs/CoastalZoneManagement/CoastalGEMSGeospatialData.aspx>].

NOTE: This website is maintained by the department. Assistance and information may be obtained by contacting Virginia Coastal Zone Management Program, Virginia Department of Environmental Quality, 629 E. Main Street, Richmond, Virginia 23219, (804) 698-4000.

2. Natural Landscape Assessment, [~~2010,~~] Virginia Department of Conservation and Recreation. Available at the following Internet address: for detailed information on ecological cores go to http://www.dcr.virginia.gov/natural_heritage/vclnavnla.shtml. Land maps may be viewed at DCR's Land Conservation Data Explorer Geographic Information System website at <http://www.vaconservedlands.org/gis.aspx>.

NOTE: The website is maintained by DCR. Actual shapefiles and metadata are available for free by contacting a DCR staff person at vaconslands@dcr.virginia.gov or DCR, Division of Natural Heritage, 217 Governor Street, Richmond, Virginia 23219, (804) 786-7951.

3. Virginia Fish and Wildlife Information Service 2010, Virginia Department of Game and Inland Fisheries. Available at the following Internet address: <http://www.vafwis.org/fwis/>.

NOTE: This website is maintained by DGIF and is accessible to the public as "visitors", or to registered subscribers. Registration, however, is required for access to

[~~resource-~~ resource-specific] or species-specific locational data and records. Assistance and information may be obtained by contacting DGIF, Fish and Wildlife Information Service, 4010 West Broad Street, Richmond, Virginia 23230, (804) 367-6913.

Part III

Provisions for Projects with Rated Capacity Less Than or Equal to Five Megawatts or Meeting Other Specified Criteria
9VAC15-70-130. Combustion energy projects with rated capacity less than or equal to five megawatts or meeting other specified criteria.

A. The owner or operator of a combustion energy project is not required to submit any notification or certification to the department if the combustion energy project has a rated capacity equal to or less than 500 kilowatts.

B. The owner or operator of a combustion energy project shall notify the department [~~by submitting~~ and shall submit] a certification by the governing body of the locality or localities wherein the project will be located that the project complies with all applicable land use ordinances, if the project meets either of the following criteria:

1. The combustion energy project has a rated capacity greater than 500 kilowatts and less than or equal to five megawatts; or

2. The combustion energy project has a rated capacity greater than five megawatts and meets all of the criteria specified in this subdivision.

a. The combustion energy project has a disturbance zone:

(1) Less than or equal to 10 acres; or

(2) Greater than 10 acres but utilizes existing parking lots, existing roads, or other previously disturbed areas and any impacts to undisturbed areas do not exceed an additional 10 acres;

b. The tallest point of the built structures does not exceed 200 feet; and

c. If utilizing or demolishing existing buildings, utilizes or demolishes existing buildings:

(1) Less than 50 years of age; or

(2) 50 years of age or older that have been evaluated and determined by DHR within the preceding seven years to be not VLR-eligible.

Part IV

Enforcement

9VAC15-70-140. Enforcement.

The department may enforce the provisions of this chapter and any permits by rule authorized under this chapter in accordance with §§ 10.1-1197.9, 10.1-1197.10, and 10.1-1197.11 of the Code of Virginia. In so doing, the department may:

1. Issue directives in accordance with the law;

2. Issue special orders in accordance with the law;

3. Issue emergency special orders in accordance with the law;
4. Seek injunction, mandamus or other appropriate remedy as authorized by the law;
5. Seek civil penalties under the law; or
6. Seek remedies under the law, or under other laws including the common law.

[DOCUMENTS INCORPORATED BY REFERENCE (9VAC15-70)

The Natural Communities of Virginia, Classification of Ecological Community Groups, Second Approximation (Version 2.3), 2010, Virginia Department of Conservation and Recreation, Division of Natural Heritage, Richmond, VA.

Virginia's Comprehensive Wildlife Conservation Strategy, 2005, Virginia Department of Game and Inland Fisheries, Richmond, Virginia.

Chapter 1: Introduction.

Chapter 2: Methods.

Chapter 3: Statewide Overview.

Chapter 4: Virginia's Mid-Atlantic Coastal Plain.

Chapter 5: Virginia's Southern Appalachian Piedmont.

Chapter 6: Virginia's Blue Ridge Mountains.

Chapter 7: Virginia's Northern Ridge and Valley.

Chapter 8: Virginia's Northern Cumberland Mountains.

Chapter 9: Virginia's Southern Cumberland Mountains.

Chapter 10: Conclusions.

Glossary.

Appendix A: The Species of Greatest Conservation Need.

Appendix B: Species of Greatest Conservation Need with No Known Ecoregional Associations.

Appendix C: Terrestrial Species with No Landcover Associations.

Appendix D: Potential Habitat Mapping for Terrestrial & Aquatic Tier I Species.

Appendix E: List of Tier I Species and Reviewers.

Appendix F: Complete list of Stress/Source Combinations Identified by the Taxonomic Advisory Committees.

Appendix G: Habitat Grouping Used by TACs in Assessment of Threats, Conservation Actions, and

Research/Monitoring Needs.

Appendix H: Threats to Virginia's Species of Greatest Conservation Need.

Appendix I: Conservation Actions Identified by the Taxonomic Advisory Committees.

Appendix J: Research and Monitoring Needs Identified by the Taxonomic Advisory Committees.

Appendix K: Landcover Classes.

Appendix L: Summaries of Community Meetings Facilitated by VCU's Center for Public Policy.

Appendix M: Recommendations for Education and Outreach Actions.

Appendix N: DEQ Impaired Waters Map.

Appendix O: Reference Maps.

Appendix P: Public Comments.]

VA.R. Doc. No. R11-2707; Filed June 28, 2013, 12:59 p.m.

STATE WATER CONTROL BOARD

Final Regulation

REGISTRAR'S NOTICE: The State Water Control Board is claiming an exclusion from the Administrative Process Act in accordance with § 2.2-4006 A 4 a of the Code of Virginia, which excludes regulations that are necessary to conform to changes in Virginia statutory law where no agency discretion is involved. The State Water Control Board will receive, consider, and respond to petitions by any interested person at any time with respect to reconsideration or revision.

Titles of Regulations: **9VAC25-31. Virginia Pollutant Discharge Elimination System (VPDES) Permit Regulation (amending 9VAC25-31-290, 9VAC25-31-360, 9VAC25-31-830, 9VAC25-31-850).**

9VAC25-32. Virginia Pollution Abatement (VPA) Permit Regulation (amending 9VAC25-32-140).

9VAC25-220. Surface Water Management Area Regulation (amending 9VAC25-220-50, 9VAC25-220-80, 9VAC25-220-190).

9VAC25-230. Procedural Rule No. 1 - Public and Formal Hearing Procedures (amending 9VAC25-230-50, 9VAC25-230-90, 9VAC25-230-130, 9VAC25-230-140, 9VAC25-230-170).

Statutory Authority:

§ 62.1-44.15 of the Code of Virginia; § 402 of the federal Clean Water Act; 40 CFR Parts 122, 123, 124, 403, and 503 (9VAC25-31-290, 9VAC25-31-360, 9VAC25-31-830, 9VAC25-31-850)

§ 62.1-44.15 of the Code of Virginia (9VAC25-32-140, 9VAC25-230-50, 9VAC25-230-90, 9VAC25-230-130, 9VAC25-230-140, 9VAC25-230-170)

Regulations

§ 62.1-249 of the Code of Virginia (9VAC25-220-50, 9VAC25-220-80, 9VAC25-220-190)

Effective Date: September 1, 2013.

Agency Contact: Cindy M. Berndt, Department of Environmental Quality, 629 East Main Street, P.O. Box 1105, Richmond, VA 23218, telephone (804) 698-4378, FAX (804) 698-4346, or email cindy.berndt@deq.virginia.gov.

Summary:

This regulatory action conforms the applicable provisions of 9VAC25-31, 9VAC25-32, 9VAC25-220, and 9VAC25-230 to Chapter 348 of the 2013 Acts of Assembly to allow certain notifications to be delivered through postal or electronic means.

9VAC25-31-290. Public notice of permit actions and public comment period.

A. Scope.

1. The board shall give public notice that the following actions have occurred:

- a. A draft permit has been prepared under 9VAC25-31-260 D;
- b. A public hearing has been scheduled under 9VAC25-31-310; or
- c. A VPDES new source determination has been made under 9VAC25-31-180.

2. No public notice is required when a request for permit modification, revocation and reissuance, or termination is denied under 9VAC25-31-370 B. Written notice of that denial shall be given to the requester and to the permittee. Public notice shall not be required for submission or approval of plans and specifications or conceptual engineering reports not required to be submitted as part of the application.

3. Public notices may describe more than one permit or permit actions.

B. Timing.

1. Public notice of the preparation of a draft permit required under subsection A of this section shall allow at least 30 days for public comment.

2. Public notice of a public hearing shall be given at least 30 days before the hearing. (Public notice of the hearing may be given at the same time as public notice of the draft permit and the two notices may be combined.)

C. Methods. Public notice of activities described in subdivision A 1 of this section shall be given by the following methods:

1. By mailing, by electronic or postal delivery, a copy of a notice to the following persons (any person otherwise entitled to receive notice under this subdivision may waive his or her rights to receive notice for any classes and categories of permits):

a. The applicant (except for VPDES general permits when there is no applicant);

b. Any other agency which the board knows has issued or is required to issue a VPDES, sludge management permit;

c. Federal and state agencies with jurisdiction over fish, shellfish, and wildlife resources and over coastal zone management plans, the Advisory Council on Historic Preservation, State Historic Preservation Officers, including any affected states (Indian Tribes);

d. Any state agency responsible for plan development under § 208(b)(2), 208(b)(4) or § 303(e) of the CWA and the U.S. Army Corps of Engineers, the U.S. Fish and Wildlife Service and the National Marine Fisheries Service;

e. Any user identified in the permit application of a privately owned treatment works;

f. Persons on a mailing list developed by:

(1) Including those who request in writing to be on the list;

(2) Soliciting persons for area lists from participants in past permit proceedings in that area; and

(3) Notifying the public of the opportunity to be put on the mailing list through periodic publication in the public press and in such publications as EPA regional and state funded newsletters, environmental bulletins, or state law journals. (The board may update the mailing list from time to time by requesting written indication of continued interest from those listed. The board may delete from the list the name of any person who fails to respond to such a request.);

g. (1) Any unit of local government having jurisdiction over the area where the facility is proposed to be located; and

(2) Each state agency having any authority under state law with respect to the construction or operation of such facility;

2. Except for permits for concentrated animal feeding operations as defined in 9VAC25-31-10 or designated in accordance with 9VAC25-31-130 B, by publication once a week for two successive weeks in a newspaper of general circulation in the area affected by the discharge. The cost of public notice shall be paid by the owner; and

3. Any other method reasonably calculated to give actual notice of the action in question to the persons potentially affected by it, including press releases or any other forum or medium to elicit public participation.

D. Contents.

1. All public notices issued under this part shall contain the following minimum information:

- a. Name and address of the office processing the permit action for which notice is being given;

- b. Name and address of the permittee or permit applicant and, if different, of the facility or activity regulated by the permit, except in the case of VPDES draft general permits;
 - c. A brief description of the business conducted at the facility or activity described in the permit application or the draft permit, for VPDES general permits when there is no application;
 - d. Name, address and telephone number of a person from whom interested persons may obtain further information, including copies of the draft permit or draft general permit, as the case may be, statement of basis or fact sheet, and the application;
 - e. A brief description of the procedures for submitting comments and the time and place of any public hearing that will be held, including a statement of procedures to request a public hearing (unless a hearing has already been scheduled) and other procedures by which the public may participate in the final permit decision;
 - f. A general description of the location of each existing or proposed discharge point and the name of the receiving water and the sludge use and disposal practice or practices and the location of each sludge treatment works treating domestic sewage and use or disposal sites known at the time of permit application. For draft general permits, this requirement will be satisfied by a map or description of the permit area;
 - g. Requirements applicable to cooling water intake structures under § 316 of the CWA, in accordance with 9VAC25-31-165; and
 - h. Any additional information considered necessary or proper.
2. In addition to the general public notice described in subdivision 1 of this subsection, the public notice of a public hearing under 9VAC25-31-310 shall contain the following information:
- a. Reference to the date of previous public notices relating to the permit;
 - b. Date, time, and place of the public hearing;
 - c. A brief description of the nature and purpose of the public hearing, including the applicable rules and procedures; and
 - d. A concise statement of the issues raised by the persons requesting the public hearing.
3. Public notice of a VPDES draft permit for a discharge where a request for alternate thermal effluent limitations has been filed shall include:
- a. A statement that the thermal component of the discharge is subject to effluent limitations incorporated in 9VAC25-31-30 and a brief description, including a quantitative statement, of the thermal effluent limitations proposed under § 301 or § 306 of the CWA;
 - b. A statement that an alternate thermal effluent limitation request has been filed and that alternative less stringent effluent limitations may be imposed on the thermal component of the discharge under the law and § 316(a) of the CWA and a brief description, including a quantitative statement, of the alternative effluent limitations, if any, included in the request; and
 - c. If the applicant has filed an early screening request for a CWA § 316(a) variance, a statement that the applicant has submitted such a plan.
- E. In addition to the general public notice described in subdivision D 1 of this section, all persons identified in subdivisions C 1 a, b, c, and d of this section shall be mailed, by electronic or postal delivery, a copy of the fact sheet or statement of basis, the permit application (if any) and the draft permit (if any).
- F. Upon receipt of an application for the issuance of a new or modified permit other than those for agricultural production or aquacultural production activities, the board shall:
- 1. Notify, in writing, the locality wherein the discharge or, as applicable, the associated land application of sewage sludge, or land disposal of treated sewage, stabilized sewage sludge or stabilized septage does or is proposed to take place of, at a minimum:
 - a. The name of the applicant;
 - b. The nature of the application and proposed discharge;
 - c. The availability and timing of any comment period; and
 - d. Upon request, any other information known to, or in the possession of, the board or the department regarding the applicant not required to be held confidential by this chapter.
 - 2. Establish a date for a public meeting to discuss technical issues relating to proposals for land application of sewage sludge, or land disposal of treated sewage, stabilized sewage sludge or stabilized septage. The department shall give notice of the date, time, and place of the public meeting and a description of the proposal by publication in a newspaper of general circulation in the city or county where the proposal is to take place. Public notice of the scheduled meeting shall occur no fewer than seven or more than 14 days prior to the meeting. The board shall not issue the permit until the public meeting has been held and comment has been received from the local governing body, or until 30 days have lapsed from the date of the public meeting.
 - 3. Except for land application of sewage sludge or land disposal of treated sewage, stabilized sewage sludge or stabilized septage, make a good faith effort to provide this same notice and information to (i) each locality and riparian property owner to a distance one-quarter mile downstream and one-quarter mile upstream or to the fall

Regulations

line whichever is closer on tidal waters and (ii) each locality and riparian property owner to a distance one-half mile downstream on nontidal waters. Distances shall be measured from the point, or proposed point, of discharge. If the receiving river at the point or proposed point of discharge is two miles wide or greater, the riparian property owners on the opposite shore need not be notified. Notice to property owners shall be based on names and addresses taken from local tax rolls. Such names and addresses shall be provided by the commissioners of the revenue or the tax assessor's office of the affected jurisdictions upon request by the board.

4. For a site that is to be added to an existing permit authorizing land application of sewage sludge, notify persons residing on property bordering such site and receive written comments from those persons for a period not to exceed 30 days. Based upon the written comments, the department shall determine whether additional site-specific requirements should be included in the authorization for land application at the site.

G. Before issuing any permit, if the board finds that there are localities particularly affected by the permit, the board shall:

1. Publish, or require the applicant to publish, a notice in a local paper of general circulation in the localities affected at least 30 days prior to the close of any public comment period. Such notice shall contain a statement of the estimated local impact of the proposed permit, which at a minimum shall include information on the specific pollutants involved and the total quantity of each which may be discharged; and

2. Mail, by electronic or postal delivery, the notice to the chief elected official and chief administrative officer and planning district commission for those localities.

Written comments shall be accepted by the board for at least 15 days after any public hearing on the permit, unless the board votes to shorten the period. For the purposes of this section, the term "locality particularly affected" means any locality which bears any identified disproportionate material water quality impact which would not be experienced by other localities.

9VAC25-31-360. Computation of time.

A. Any time period scheduled to begin on the occurrence of an act or event shall begin on the day after the act or event.

B. Any time period scheduled to begin before the occurrence of an act or event shall be computed so that the period ends on the day before the act or event.

C. If the final day of any time period falls on a weekend or legal holiday, the time period shall be extended to the next working day.

D. Whenever a party or interested person has the right or is required to act within a prescribed period after the service of notice or other paper upon him or her by mail, electronic or

postal delivery, three days shall be added to the prescribed time.

9VAC25-31-830. Approval procedures for POTW pretreatment programs and POTW granting of removal credits.

The following procedures shall be adopted in approving or denying requests for approval of POTW pretreatment programs and applications for removal credit authorization:

A. The director shall have 90 days from the date of public notice of any submission complying with the requirements of 9VAC25-31-810 B and, where removal credit authorization is sought with 9VAC25-31-790 E and 9VAC25-31-810 D, to review the submission. The director shall review the submission to determine compliance with the requirements of 9VAC25-31-800 B and F, and, where removal credit authorization is sought, with 9VAC25-31-790. The director may have up to an additional 90 days to complete the evaluation of the submission if the public comment period provided for in subdivision B 1 b of this section is extended beyond 30 days or if a public hearing is held as provided for in subdivision B 2 of this section. In no event, however, shall the time for evaluation of the submission exceed a total of 180 days from the date of public notice of a submission meeting the requirements of 9VAC25-31-810 B and, in the case of a removal credit application, 9VAC25-31-790 E and 9VAC25-31-810 B.

B. Upon receipt of a submission, the director shall commence its review. Within 20 work days after making a determination that a submission meets the requirements of 9VAC25-31-810 B and, where removal allowance approval is sought, 9VAC25-31-790 D and 9VAC25-31-810 D, the director shall:

1. Issue a public notice of request for approval of the submission.

a. This public notice shall be circulated in a manner designed to inform interested and potentially interested persons of the submission. Procedures for the circulation of public notice shall include:

(1) Mailing, by electronic or postal delivery, notices of the request for approval of the submission to designated CWA § 208 planning agencies, federal and state fish, shellfish, and wildlife resource agencies (unless such agencies have asked not to be sent the notices); and to any other person or group who has requested individual notice, including those on appropriate mailing lists; and

(2) Publication of a notice of request for approval of the submission in a newspaper(s) of general circulation within the jurisdiction(s) served by the POTW that provides meaningful public notice.

b. The public notice shall provide a period of not less than 30 days following the date of the public notice during which time interested persons may submit their written views on the submission.

c. All written comments submitted during the 30-day comment period shall be retained by the director and considered in the decision on whether or not to approve the submission. The period for comment may be extended at the discretion of the director.

2. Provide an opportunity for the applicant, any affected state, any interested state or federal agency, person or group of persons to request a public hearing with respect to the submission.

a. This request for public hearing shall be filed within the 30-day (or extended) comment period described in subdivision 1 b of this subsection and shall indicate the interest of the person filing such request and the reasons why a public hearing is warranted.

b. The director shall hold a public hearing if the POTW so requests. In addition, a public hearing will be held if there is a significant public interest in issues relating to whether or not the submission should be approved. Instances of doubt should be resolved in favor of holding the public hearing.

c. Public notice of a public hearing to consider a submission and sufficient to inform interested parties of the nature of the public hearing and the right to participate shall be published in the same newspaper(s) as the notice of the original request for approval of the submission under subdivision 1 a (2) of this subsection. In addition, notice of the public hearing shall be sent to those persons requesting individual notice.

C. At the end of the 30-day (or extended) comment period and within the 90-day (or extended) period provided for in subsection A of this section, the director shall approve or deny the submission based upon the evaluation in subsection A of this section and taking into consideration comments submitted during the comment period and the record of the public hearing, if held. Where the director makes a determination to deny the request, the director shall so notify the POTW and each person who has requested individual notice. This notification shall include suggested modifications and the director may allow the requestor additional time to bring the submission into compliance with applicable requirements.

D. No POTW pretreatment program or authorization to grant removal allowances shall be approved by the director if following the 30-day (or extended) evaluation period provided for in subdivision B 1 b of this section and any public hearing held pursuant to subdivision B 2 of this section, the regional administrator sets forth in writing objections to the approval of such submission and the reasons for such objections. A copy of the regional administrator's objections shall be provided to the applicant and each person who has requested individual notice. The regional administrator shall provide an opportunity for written comments and may convene a public hearing on his objections. Unless retracted, the regional administrator's

objections shall constitute a final ruling to deny approval of a POTW pretreatment program or authorization to grant removal allowances 90 days after the date the objections are issued.

E. The director shall notify those persons who submitted comments and participated in the public hearing, if held, of the approval or disapproval of the submission. In addition, the director shall cause to be published a notice of approval or disapproval in the same newspapers as the original notice of request for approval of the submission was published. The director shall identify in any notice of POTW pretreatment program approval any authorization to modify categorical pretreatment standards which the POTW may make, in accordance with 9VAC25-31-790, for removal of pollutants subject to pretreatment standards.

F. The director shall ensure that the submission and any comments upon such submission are available to the public for inspection and copying.

9VAC25-31-850. Variances from categorical pretreatment standards for fundamentally different factors.

A. The term "requester" means an industrial user or a POTW or other interested person seeking a variance from the limits specified in a categorical pretreatment standard.

B. Any interested person believing that factors relating to an industrial user are fundamentally different from the factors considered during development of a categorical pretreatment standard applicable to that user and further, that the existence of those factors justifies a different discharge limit than specified in the applicable categorical pretreatment standard, may request a fundamentally different factors variance under this section.

C. Criteria.

1. General criteria. A request for a variance based upon fundamentally different factors shall be approved only if:

a. There is an applicable categorical pretreatment standard which specifically controls the pollutant for which alternative limits have been requested;

b. Factors relating to the discharge controlled by the categorical pretreatment standard are fundamentally different from the factors considered by EPA in establishing the standards; and

c. The request for a variance is made in accordance with the procedural requirements in subsections G and H of this section.

2. Criteria applicable to less stringent limits. A variance request for the establishment of limits less stringent than required by the standard shall be approved only if:

a. The alternative limit requested is no less stringent than justified by the fundamental difference;

b. The alternative limit will not result in a violation of prohibitive discharge standards prescribed by or established under 9VAC25-31-770;

Regulations

c. The alternative limit will not result in a nonwater quality environmental impact (including energy requirements) fundamentally more adverse than the impact considered during development of the pretreatment standards; and

d. Compliance with the standards (either by using the technologies upon which the standards are based or by using other control alternatives) would result in either:

(1) A removal cost (adjusted for inflation) wholly out of proportion to the removal cost considered during development of the standards; or

(2) A nonwater quality environmental impact (including energy requirements) fundamentally more adverse than the impact considered during development of the standards.

3. Criteria applicable to more stringent limits. A variance request for the establishment of limits more stringent than required by the standards shall be approved only if:

a. The alternative limit request is no more stringent than justified by the fundamental difference; and

b. Compliance with the alternative limit would not result in either:

(1) A removal cost (adjusted for inflation) wholly out of proportion to the removal cost considered during development of the standards; or

(2) A nonwater quality environmental impact (including energy requirements) fundamentally more adverse than the impact considered during development of the standards.

D. Factors considered fundamentally different. Factors which may be considered fundamentally different are:

1. The nature or quality of pollutants contained in the raw waste load of the user's process wastewater;

2. The volume of the user's process wastewater and effluent discharged;

3. Nonwater quality environmental impact of control and treatment of the user's raw waste load;

4. Energy requirements of the application of control and treatment technology;

5. Age, size, land availability, and configuration as they relate to the user's equipment or facilities; processes employed; process changes; and engineering aspects of the application of control technology; and

6. Cost of compliance with required control technology.

E. Factors which will not be considered fundamentally different. A variance request or portion of such a request under this section may not be granted on any of the following grounds:

1. The feasibility of installing the required waste treatment equipment within the time the CWA allows;

2. The assertion that the standards cannot be achieved with the appropriate waste treatment facilities installed, if such assertion is not based on factors listed in subsection D of this section;

3. The user's ability to pay for the required waste treatment; or

4. The impact of a discharge on the quality of the POTW's receiving waters.

F. Local law. Nothing in this section shall be construed to impair the right of any locality under the Code of Virginia or § 510 of the CWA to impose more stringent limitations than required by federal law.

G. Application deadline.

1. Requests for a variance and supporting information must be submitted in writing to the department or to the administrator, as appropriate.

2. In order to be considered, a request for a variance must be submitted no later than 180 days after the date on which a categorical pretreatment standard is published in the Federal Register.

3. Where the user has requested a categorical determination pursuant to 9VAC25-31-780 A, the user may elect to await the results of the category determination before submitting a variance request under this section. Where the user so elects, he must submit the variance request within 30 days after a final decision has been made on the categorical determination pursuant to 9VAC25-31-780 A 4.

H. Contents submission. Written submissions for variance requests, whether made to the administrator or the department, must include:

1. The name and address of the person making the request;

2. Identification of the interest of the requester which is affected by the categorical pretreatment standard for which the variance is requested;

3. Identification of the POTW currently receiving the waste from the industrial user for which alternative discharge limits are requested;

4. Identification of the categorical pretreatment standards which are applicable to the industrial user;

5. A list of each pollutant or pollutant parameter for which an alternative discharge limit is sought;

6. The alternative discharge limits proposed by the requester for each pollutant or pollutant parameter identified in subdivision 5 of this subsection;

7. A description of the industrial user's existing water pollution control facilities;

8. A schematic flow representation of the industrial user's water system including water supply, process wastewater systems, and points of discharge; and

9. A statement of facts clearly establishing why the variance request should be approved, including detailed support data, documentation, and evidence necessary to fully evaluate the merits of the request, e.g., technical and economic data collected by the EPA and used in developing each pollutant discharge limit in the pretreatment standard.

I. Deficient requests. The administrator or the director will only act on written requests for variances that contain all of the information required. Persons who have made incomplete submissions will be notified by the administrator or the director that their requests are deficient and unless the time period is extended, will be given up to 30 days to remedy the deficiency. If the deficiency is not corrected within the time period allowed by the administrator or the director, the request for a variance shall be denied.

J. Public notice. Upon receipt of a complete request, the administrator or the director will provide notice of receipt, opportunity to review the submission, and opportunity to comment.

1. The public notice shall be circulated in a manner designed to inform interested and potentially interested persons of the request. Procedures for the circulation of public notice shall include mailing, by electronic or postal delivery, notices to:

- a. The POTW into which the industrial user requesting the variance discharges;
- b. Adjoining states whose waters may be affected; and
- c. Designated 208 planning agencies, federal and state fish, shellfish and wildlife resource agencies; and to any other person or group who has requested individual notice, including those on appropriate mailing lists.

2. The public notice shall provide for a period not less than 30 days following the date of the public notice during which time interested persons may review the request and submit their written views on the request.

3. Following the comment period, the administrator or the director will make a determination on the request taking into consideration any comments received. Notice of this final decision shall be provided to the requester (and the industrial user for which the variance is requested if different), the POTW into which the industrial user discharges and all persons who submitted comments on the request.

K. Review of requests.

1. Where the director finds that fundamentally different factors do not exist, he may deny the request and notify the requester (and industrial user where they are not the same) and the POTW of the denial.

2. Where the director finds that fundamentally different factors do exist, he shall forward the request, with a recommendation that the request be approved, to the administrator.

Part III
Public Involvement

9VAC25-32-140. Public notice of VPA permit action and public comment period.

A. Every draft VPA permit shall be given public notice, paid for by the owner, by publication once a week for two successive weeks in a newspaper of general circulation in the area affected by the pollutant management activity.

B. Interested persons shall have a period of at least 30 days following the date of the initial newspaper public notice to submit written comments on the tentative decision and to request a public hearing.

C. The contents of the public notice of an application for a VPA permit shall include:

- 1. The name and address of the applicant. If the location of the pollutant management activity differs from the address of the applicant the notice shall also state the location of the pollutant management activity including storage and land application sites;
- 2. A brief description of the business or activity conducted at the facility;
- 3. A statement of the tentative determination to issue or deny a VPA permit;
- 4. A brief description of the final determination procedure;
- 5. The address and phone number of a specific person at the state office from whom further information may be obtained; and
- 6. A brief description of how to submit comments and request a hearing.

D. Public notice shall not be required for submission or approval of plans and specifications or conceptual engineering reports not required to be submitted as part of the application.

E. Upon receipt of an application for a permit or for a modification of a permit, the board shall:

- 1. Cause to be notified, in writing, the locality wherein the pollutant management activity does or is proposed to take place. This notification shall, at a minimum, include:
 - a. The name of the applicant;
 - b. The nature of the application and proposed pollutant management activity; and
 - c. Upon request, any other information known to, or in the possession of, the board or the department regarding the application except as restricted by 9VAC25-32-150.

2. Establish a date for a public meeting to discuss technical issues relating to proposals for land application of biosolids or land disposal of treated sewage, stabilized sewage sludge or stabilized septage. The department shall give notice of the date, time, and place of the public meeting and a description of the proposal by publication in a newspaper of general circulation in the city or county

Regulations

where the proposal is to take place. Public notice of the scheduled meeting shall occur no fewer than seven or more than 14 days prior to the meeting. The board shall not issue the permit until the public meeting has been held and comment has been received from the local governing body or until 30 days have lapsed from the date of the public meeting.

F. Before issuing any permit, if the board finds that there are localities particularly affected by the permit, the board shall:

1. Publish, or require the applicant to publish, a notice in a local paper of general circulation in the localities affected at least 30 days prior to the close of any public comment period. Such notice shall contain a statement of the estimated local impact of the proposed permit, which at a minimum shall include information on the specific pollutants involved and the total quantity of each which may be discharged; and

2. Mail, by electronic or postal delivery, the notice to the chief elected official and chief administrative officer and planning district commission for those localities.

Written comments shall be accepted by the board for at least 15 days after any public hearing on the permit, unless the board votes to shorten the period. For the purposes of this section, the term "locality particularly affected" means any locality which bears any identified disproportionate material water quality impact which would not be experienced by other localities.

G. When a site is to be added to an existing permit authorizing land application of biosolids, the department shall notify persons residing on property bordering such site, and shall receive written comments from those persons for a period not to exceed 30 days. Based upon the written comments, the department shall determine whether additional site-specific requirements should be included in the authorization for land application at the site.

9VAC25-220-50. Notice of surface water management area.

A. The board shall cause notice of the declaration of a surface water management area to be published in a newspaper of general circulation throughout the area covered by the declaration.

B. The board shall mail, by electronic or postal delivery, a copy of its decision on the proposed declaration of a surface water management area to the mayor or chairman of the governing body of each county, city or town within which any part of the area lies, or which is known by the board to make offstream use of water from the area, and to the chief administrative officer of any federal facility known by the board to be using water from within the area.

9VAC25-220-80. Conditions applicable to all permits.

A. Duty to comply. The permittee shall comply with all conditions of the permit. Nothing in this chapter shall be construed to relieve the surface water withdrawal permit

holder of the duty to comply with all applicable federal and state statutes, regulations, standards and prohibitions. Any permit noncompliance is a violation of the law, and is grounds for enforcement action, permit suspension, cancellation, revocation, modification or denial of a permit renewal application.

B. Duty to mitigate. The permittee shall take all reasonable steps to (i) avoid all adverse environmental impact which could result from the activity, (ii) where avoidance is impractical, minimize the adverse environmental impact, and (iii) where impacts cannot be avoided, provide mitigation of the adverse impact on an in-kind basis.

C. Permit action.

1. A permit may be modified, revoked, suspended, cancelled, reissued, or terminated as set forth in this chapter.

2. If a permittee files a request for permit modification, suspension or cancellation, or files a notification of planned changes, or anticipated noncompliance, the permit terms and conditions shall remain effective until the request is acted upon by the board. This provision shall not be used to extend the expiration date of the effective permit.

3. Permits may be modified, revoked and reissued or terminated upon the request of the permittee, or upon board initiative to reflect the requirements of any changes in the statutes or regulations.

D. Inspection and entry. Upon presentation of credentials, any duly authorized agent of the board may, at reasonable times and under reasonable circumstances:

1. Enter upon any permittee's property, public or private, and have access to, inspect and copy any records that must be kept as part of the permit conditions;

2. Inspect any facilities, operations or practices including monitoring and control equipment regulated or required under the permit.

E. Duty to provide information. The permittee shall furnish to the board, within a reasonable time, any information which the board may request to determine whether cause exists for modifying, reissuing, suspending and cancelling the permit, or to determine compliance with the permit. The permittee shall also furnish to the board, upon request, copies of records required to be kept by the permittee. This information shall be furnished to the board pursuant to § 62.1-244 of the Code of Virginia.

F. Monitoring and records requirements.

1. Monitoring shall be conducted according to approved methods as specified in the permit or as approved by the board;

2. Measurements taken for the purpose of monitoring shall be representative of the monitored activity;

3. The permittee shall retain records of all monitoring information, including all calibration and maintenance records and all original strip chart or electronic recordings for continuous monitoring instrumentation, copies of all reports required by the permit, and records of all data used to complete the application for the permit, for a period of at least three years from the date of the expiration of a granted permit. This period may be extended by request of the board at any time.

4. Records of monitoring information shall include:

- a. The date, exact place and time of measurements;
- b. The name of the individuals who performed the measurements;
- c. The date the measurements were compiled;
- d. The name of the individuals who compiled the measurements;
- e. The techniques or methods supporting the information such as observations, readings, calculations and bench data used; and
- f. The results of such techniques or methods.

G. Permit conditions become applicable.

1. Permit conditions become applicable in a surface water management area upon notice by the board to each permittee by mail, by electronic or postal delivery, or cause notice of that to be published in a newspaper of general circulation throughout the area.

2. The board shall notify each permittee by mail or cause notice of that to be published in a newspaper of general circulation throughout the surface water management area when the declaration of water shortage is rescinded.

9VAC25-220-190. Public notice that permit conditions are in force.

A. When permit conditions become applicable in a surface water management area, the board shall notify each permittee by mail, electronic or postal delivery, or cause notice of it to be published in a newspaper of general circulation throughout the area.

B. The board shall notify each permittee by mail, electronic or postal delivery, or cause notice of it to be published in a newspaper of general circulation throughout the surface water management area when the declaration of water shortage is rescinded.

9VAC25-230-50. Disposition of requests for public hearing.

A. The executive secretary shall review all timely requests for public hearing filed in accordance with the provisions of 9VAC25-230-40, and within 30 calendar days following the expiration of the time period for the submission of requests shall grant a public hearing if he finds the following:

1. That there is a significant public interest in the issuance, denial, modification or revocation of the permit in question; and

2. That there are substantial, disputed issues relevant to the issuance, denial, modification or revocation of the permit in questions; and

3. That the action requested is not on its face inconsistent with, or in violation of, the Water Control Law, federal law or any regulation promulgated thereunder; or

4. That a public hearing is required by statute.

B. The executive secretary shall, forthwith, notify by mail, by electronic or postal delivery, at his last known address (i) each requester and (ii) the applicant or permittee of his decision to convene or deny a public hearing.

C. If the executive secretary determines to hold a public hearing, he shall schedule the hearing at a time between 30 and 60 days after mailing of the notice required by 9VAC25-230-50 B.

D. The executive secretary shall cause notice of a public hearing under Regulation 6 to be published as required by § 6.37. The executive secretary shall cause notice of any public hearing under Rule No. 2 or Rule No. 3, (9VAC25-240-10 et seq.) to be published as follows:

1. A notice of the hearing shall be published once, in a newspaper of general circulation in the city or county where the facility or operation that is the subject of the permit or permit application is located, at least 30 days before the hearing date.

2. The notices mailed under 9VAC25-230-50B and published under 9VAC25-230-50D 1 shall contain the information specified in § 2.06 or 9VAC25-240-50, as appropriate, except that in the description of procedures for final determinations, the procedures for requesting a public hearing shall be replaced by a brief statement of the public hearing procedures and the issues upon which comment will be received.

E. In matters not related to the issuance, denial, modification, or revocation of a permit, the executive secretary may schedule public hearing upon his own motion in any location and upon any notice permitted by law.

9VAC25-230-90. Decision of the board following public hearing.

After the close of the informal hearing, the board shall make a final decision to issue, deny, modify or revoke the permit in question or take or not take any other action proposed. In making its decision the board shall consider the entire record of the proceeding, and any staff report. The decision of the board rendered after a public hearing must be reduced to writing and contain a statement of the basis upon which the decision was reached. Copies of the decision, certified by the executive secretary, shall be mailed by certified mail, in accordance with § 10.1-1183 of the Code of Virginia, to all parties to the hearing.

Regulations

9VAC25-230-130. Petition for formal hearing.

A. The applicant or permittee or any person aggrieved by any action or inaction of the board or executive secretary with respect to a permit or arising out of the public hearing procedures outlined above may petition the executive secretary for the convening of a formal hearing as described in 9VAC25-230-100 and following. If filed by an aggrieved owner under § 62.1-44.25 of the Code of Virginia, the petition must be filed within 30 days of the mailing of notice of the action appealed from to that owner by certified mail in accordance with § 10.1-1183 of the Code of Virginia; otherwise the petition must be filed within 30 calendar days of the action appealed from. The executive secretary shall acknowledge in writing the receipt of all petitions for formal hearing.

B. The petition shall contain the following:

1. The names and addresses of the petitioner, the petitioner's counsel (if any) and all persons for whom the petitioner is acting as a representative (for the purposes of this requirement, an unincorporated association is a person);
2. A statement of the action appealed from;
3. A statement setting forth the interest of the petitioner and explaining how and to what extent the action appealed from will directly and adversely affect such interest;
4. A statement setting forth the errors alleged in the Board's action and the reasons why such action is deemed contrary to law;
5. A statement by the petitioner that, should its petition be granted and a hearing held pursuant thereto, the petitioner and all persons represented by the petitioner in connection with the appeal will be available, without cost to any other party, to appear at such hearing; and
6. A statement setting forth the specific relief requested.

C. The executive secretary shall consider all petitions filed in accordance with 9VAC25-230-130, and shall authorize the convening of a formal hearing if he finds that:

1. A petition meeting the requirements of 9VAC25-230-130 B has been filed by the applicant or permittee or any owner having the right to demand a hearing under § 62.1-44.25 of the Code of Virginia; or
2. A petition meeting the requirements of 9VAC25-230-130 B has been filed by a person other than the applicant or permittee, and the petition raises genuine and substantial issues of law or fact which, if resolved adversely to the petitioner, would result in an injury to an interest of the petitioner. The executive secretary also may authorize a formal hearing on his own motion.

D. The executive secretary shall notify the applicant or permittee, all other petitioners, and all persons who presented testimony or views at the public hearing by mail, electronic or postal delivery, of his decision to authorize or deny a hearing.

Should a hearing be authorized, he shall at the same time notify the applicant or permittee and all petitioners for a formal hearing of the date and place of the hearing and advise them of the assertions of fact and law made by the petitioners. The hearing shall be scheduled to be held not less than 30, nor more than 60 days from the date of such notice. When the executive secretary authorizes a hearing on his own motion, he shall give at least 30 days' notice by certified mail to the affected applicant, permittee or proposed recipient of a special order. Except for special order hearings, the executive secretary shall further give notice by newspaper publication.

E. The executive secretary may at the request of the applicant, permittee, or any party reschedule the date for the formal hearing. The executive secretary will promptly notify all parties of any rescheduled hearing date.

9VAC25-230-140. Petition to become a party to a formal hearing.

A. Any person may, at any time after a petition for formal hearing has been filed or the executive secretary has authorized a formal hearing on his own motion, but not more than 15 days after mailing, by electronic or postal delivery, or publication of notice, whichever is later, of the executive secretary's decision to authorize a formal hearing, petition the executive secretary to become a party to the formal hearing. The executive secretary shall acknowledge in writing the receipt of all petitions to become a party. A petition for a hearing filed in accordance with 9VAC25-230-130 shall also be deemed a petition to be a party to any hearing that may be authorized in accordance with such petition.

1. The petition to become a party shall contain the following:

- a. The names and addresses of the petitioner, the petitioner's counsel (if any) and all persons for whom the petitioner is acting as a representative;
- b. A statement setting forth the interest of the petitioner in the matter;
- c. A statement by the petitioner that, should its petition be granted, the petitioner and all persons represented by the petitioner in connection with the hearing will be available, without cost to any other party, to appear at the hearing;
- d. A statement setting forth the position of the petitioner with respect to any errors alleged in the petition for hearing; and
- e. A statement setting forth any cross- errors alleged in the board's action.

2. The executive secretary shall consider all petitions filed in accordance herewith, and shall grant those petitions that both:

- a. Meet the requirements of subsection 1 above; and
- b. Raise one or more genuine and substantial issues in the petition for hearing, or cite one or more issues in the

hearing notice, which, if resolved adversely to the petitioner, would result in an injury to an interest of the petitioner.

3. The executive secretary shall notify the applicant or permittee, and all other parties by mail, electronic or postal delivery, of his decision to grant or deny a petition to become a party.

9VAC25-230-170. Record of proceedings, proposed findings and conclusions from formal hearing.

A. A verbatim record of the hearing shall be made by a court reporter. The executive secretary or his designee shall act as custodian of the record, which shall include the transcript along with all written testimony, arguments, exhibits, reports, studies, and documents or written material of any kind submitted by the staff or the parties and admitted under 9VAC25-230-150 and 9VAC25-230-160, and offers of proof placed in the record under 9VAC25-230-160 C. A copy of the record shall be maintained for public inspection at the board's headquarters in Richmond. Where a subordinate hearing officer presides over the hearing, he shall promptly certify the original record as the true and official transcript of the proceedings, including a statement that the evidence contained in it and the exhibits to it appended represent all of the testimony offered and received into evidence at the hearing.

B. When the hearing is before the board, parties to the hearing may submit proposed findings of fact, conclusions of law and a statement of reasons therefore to the board. Such proposed findings shall be in writing, shall cite relevant authority, and shall be submitted prior to or at the hearing unless the board specifically allows submission after the hearing.

C. When the hearing is not before the full board, parties to the hearing may present oral arguments to the hearing officer and may submit proposed findings of fact, conclusions of law and a statement of reasons therefore to the executive secretary. Such proposed findings, conclusions and statement shall be in writing, shall cite relevant authority, and shall be submitted at a time prescribed by the hearing officer, which shall not be later than ten days after the hearing unless otherwise authorized by the hearing officer. The hearing officer shall consider the proposed findings, conclusions and statements timely submitted by the parties. He shall prepare his own recommended findings and decision and, promptly after the close of the hearing, transmit them to the board along with the hearing record. At the time of transmittal of the record, the hearing officer shall mail, by electronic or postal delivery, copies of his recommended findings and decision to the parties. The board will receive and act upon exceptions to those recommended findings and conclusions for 21 days after their mailing, by electronic or postal delivery, to the parties. The proposed findings and conclusions submitted by any party are advisory only, and shall not be binding on the hearing officer or the board. But

they shall be included in the hearing record and the board and the hearing officer shall be required to consider them in making any decision under this.

VA.R. Doc. No. R13-3715; Filed June 26, 2013; 3:57 p.m.

Final Regulation

Titles of Regulations: **9VAC25-20. Fees for Permits and Certificates (amending 9VAC25-20-20, 9VAC25-20-60, 9VAC25-20-90, 9VAC25-20-100, 9VAC25-20-110, 9VAC25-20-120, 9VAC25-20-142, 9VAC25-20-146, 9VAC25-20-147, 9VAC25-20-148, 9VAC25-20-149).**

9VAC25-31. Virginia Pollutant Discharge Elimination System (VPDES) Permit Regulation (amending 9VAC25-31-10, 9VAC25-31-60, 9VAC25-31-100, 9VAC25-31-260, 9VAC25-31-280, 9VAC25-31-290, 9VAC25-31-390, 9VAC25-31-420, 9VAC25-31-440, 9VAC25-31-460, 9VAC25-31-475, 9VAC25-31-480, 9VAC25-31-485, 9VAC25-31-490, 9VAC25-31-500, 9VAC25-31-505, 9VAC25-31-510, 9VAC25-31-530, 9VAC25-31-540, 9VAC25-31-550, 9VAC25-31-560, 9VAC25-31-570, 9VAC25-31-580, 9VAC25-31-590, 9VAC25-31-690, 9VAC25-31-710, 9VAC25-31-720; adding 9VAC25-31-543, 9VAC25-31-545, 9VAC25-31-547).

9VAC25-32. Virginia Pollution Abatement (VPA) Permit Regulation (amending 9VAC25-32-10, 9VAC25-32-30, 9VAC25-32-40, 9VAC25-32-60, 9VAC25-32-80, 9VAC25-32-100, 9VAC25-32-140, 9VAC25-32-240, 9VAC25-32-260, 9VAC25-32-300, 9VAC25-32-320, 9VAC25-32-330, 9VAC25-32-360, 9VAC25-32-400, 9VAC25-32-410, 9VAC25-32-420, 9VAC25-32-450, 9VAC25-32-460, 9VAC25-32-480, 9VAC25-32-490, 9VAC25-32-530, 9VAC25-32-540, 9VAC25-32-550, 9VAC25-32-560, 9VAC25-32-570, 9VAC25-32-580, 9VAC25-32-690, 9VAC25-32-700, 9VAC25-32-760; adding 9VAC25-32-303, 9VAC25-32-305, 9VAC25-32-307, 9VAC25-32-313, 9VAC25-32-315, 9VAC25-32-317, 9VAC25-32-356, 9VAC25-32-357, 9VAC25-32-358, 9VAC25-32-359, 9VAC25-32-515, 9VAC25-32-545, 9VAC25-32-665, 9VAC25-32-675, 9VAC25-32-685, 9VAC25-32-770, 9VAC25-32-780, 9VAC25-32-790, 9VAC25-32-800, 9VAC25-32-810, 9VAC25-32-820, 9VAC25-32-830, 9VAC25-32-840, 9VAC25-32-850; repealing 9VAC25-32-310, 9VAC25-32-340, 9VAC25-32-355, 9VAC25-32-370, 9VAC25-32-380, 9VAC25-32-390, 9VAC25-32-440, 9VAC25-32-500, 9VAC25-32-510, 9VAC25-32-520, 9VAC25-32-590, 9VAC25-32-600, 9VAC25-32-610, 9VAC25-32-620, 9VAC25-32-630, 9VAC25-32-640, 9VAC25-32-650, 9VAC25-32-660, 9VAC25-32-670, 9VAC25-32-680).

Statutory Authority: § 62.1-44.15 of the Code of Virginia (9VAC25-31 and 9VAC25-32).

§§ 62.1-14 and 62.1-44.15:6 of the Code of Virginia (9VAC25-20).

Effective Date: September 1, 2013.

Regulations

Agency Contact: William K. Norris, Department of Environmental Quality, 629 East Main Street, P.O. Box 1105, Richmond, VA 23218, telephone (804) 698-4022, FAX (804) 698-4347, or email william.norris@deq.virginia.gov.

Summary:

The amendments address the regulation of biosolids (treated sewage sludge) in a comprehensive manner that covers land application permitted under the Virginia Pollutant Abatement Permit (VPA) Regulation as well as the Virginia Pollutant Discharge Elimination System (VPDES) Permit Regulation. The changes address various issues related to the land application of biosolids, including the following major topics: (i) storage requirements, (ii) permit fees, (iii) site access control, (iv) consistency between VPA and VPDES permit requirements, (v) public notice processes, (vi) permit modification procedures, (vii) processes to establish appropriate buffers to address health concerns, (viii) sampling requirements, (ix) nutrient management requirements, (x) animal health issues associated with grazing, (xi) financial assurance procedures, (xii) permitting procedures, (xiii) distribution and marketing of exceptional quality biosolids, (xiv) reclamation of mined and disturbed lands, and (xv) reimbursement of local monitors.

Changes since publication of the proposed regulation (i) add a requirement for a physician's note when an extended setback from an occupied dwelling or property line is requested and (ii) require that notification signs posted at land application sites not be removed for 30 days after land application concludes at permitted sites.

Summary of Public Comments and Agency's Response: A summary of comments made by the public and the agency's response may be obtained from the promulgating agency or viewed at the office of the Registrar of Regulations.

9VAC25-20-20. Purpose.

Section 62.1-44.15:6 of the Code of Virginia requires the promulgation of regulations establishing a fee assessment and collection system to recover a portion of the State Water Control Board's, Department of Game and Inland Fisheries', and the Department of Conservation and Recreation's direct and indirect costs associated with the processing of an application to issue, reissue, or modify any permit, permit authorization or certificate which the board has the authority to issue from the applicant for such permit, permit authorization or certificate. Section 62.1-44.19:3 of the Code of Virginia requires the promulgation of regulations establishing a fee to be charged to all permit holders and persons applying for permits and permit modifications associated with land application of ~~sewage sludge~~ biosolids. Section 62.1-44.19:3 of the Code of Virginia also requires the promulgation of regulations requiring the payment of a fee by persons land applying ~~sewage sludge~~ biosolids. These

regulations establish the required fee assessment and collection system.

Part II

Payment, Deposits and Use of Fees

9VAC25-20-60. Due dates.

A. Virginia Pollutant Discharge Elimination System (VPDES) and Virginia Pollution Abatement (VPA) permits.

1. Application fees for all new permit applications are due on the day an application is submitted and shall be paid in accordance with 9VAC25-20-70 A. Applications will not be processed without payment of the required fee.

2. For reissuance of permits that expire on or before December 27, 2004, the application fee for new permit applications as set forth in this regulation is due on the day the application is submitted.

3. An application fee is due on the day an application is submitted for either a major modification or a permit reissuance that occurs (and becomes effective) before the stated permit expiration date. There is no application fee for a regularly scheduled renewal of an individual permit for an existing facility, unless the permit for the facility expires on or before December 27, 2004. There is no application fee for a major modification or amendment that is made at the board's initiative.

4. Permit maintenance fees shall be paid to the board by October 1 of each year. Additional permit maintenance fees for facilities that are authorized to land apply [, distribute, or market] biosolids [;] are in a toxics management program, ~~and for facilities that [;] or~~ have more than five process wastewater discharge outfalls at a single facility (not including "internal" outfalls) shall also be paid to the board by October 1 of each year. No permit will be reissued or ~~[automatically administratively]~~ continued without payment of the required fee.

a. Existing individual permit holders with an effective permit as of July 1, 2004; (including permits that have been administratively continued) shall pay the permit maintenance fee or fees to the board by October 1, 2004, unless one of the following conditions apply:

(1) The permit is terminated prior to October 1, 2004; or

(2) The permit holder applied or reapplied for a municipal minor VPDES permit with a design flow of 10,000 gallons per day or less between July 1, 2003, and July 1, 2004, and paid the applicable permit application fee.

b. Effective April 1, 2005, any permit holder whose permit is effective as of April 1 of a given year (including permits that have been administratively continued) shall pay the permit maintenance fee or fees to the board by October 1 of that same year.

B. Surface Water Withdrawal (SWW) and [Ground Water Groundwater] Withdrawal (GWW) permits.

1. All permit application fees are due on the day an application is submitted and shall be paid in accordance with 9VAC25-20-70 A. Applications will not be processed without payment of the required fee. No permit will be ~~automatically administratively~~ continued without payment of the required fee.

2. For reissuance of GWW permits that expire on or before March 27, 2005, the application fee for new permit applications as set forth in this regulation is due on the day the application is submitted.

3. Application fees for major modifications or amendments are due on the day an application is submitted. Applications will not be processed without payment of the required fee. There is no fee for a major modification or amendment that is made at the board's initiative.

C. Virginia Water Protection (VWP) permits.

1. VWP permit application fees shall be paid in accordance with 9VAC25-20-70 A. Review of applications may be initiated before the fee is received; however, draft permits or authorizations shall not be issued prior to payment of the required fee. No permit or permit authorization shall be ~~automatically administratively~~ continued without payment of the required fee.

2. VWP application fees for major modifications shall be paid in accordance with 9VAC25-20-70 A. Review of applications may be initiated before the fee is received; however, major modifications shall not be issued prior to payment of the required fee. There is no application fee for a major modification that is made at the board's initiative.

D. ~~Sewage sludge Biosolids~~ land application fees. ~~Except as specified in this regulation, all fees are due on the day specified by the department. Payment of the fee shall be made by land appliers following notification by the department of the fee due. The department may bill the land applier for amounts due following the submission of the monthly land application report. Payments are due 30 days after receipt of a bill from the department. No permit or modification of an existing permit will be approved in the jurisdiction where payment of the established fee by the land applier has not been received by the due date; until such time that the fees are paid in full. Existing permits may be revoked or approved sources may be reclassified as unapproved unless the required fee is paid within 60 days of the notification by the department of the fee due by the due date. No permit will be reissued or administratively continued or modified without full payment of any past due fee.~~

9VAC25-20-90. Deposit and use of fees.

A. Sludge Management Fund. All ~~sewage sludge biosolids~~ land application fees collected from permit holders who land apply ~~sewage sludge biosolids~~ in the Commonwealth of Virginia, and fees collected from permit holders and persons applying for permits and permit modifications pursuant to § 62.1-44.19:3 of the Code of Virginia shall be deposited into

the Sludge Management Fund established by, and used and accounted for as specified in § 62.1-44.19:3 of the Code of Virginia. Payments to the Department of Conservation and Recreation for their costs related to implementation of the ~~sewage sludge biosolids~~ land application program and to localities with duly adopted ordinances providing for the testing and monitoring of the land application of ~~sewage sludge biosolids~~ will be made from this fund. Fees collected shall be exempt from statewide indirect costs charged and collected by the Department of Accounts and shall not supplant or reduce the general fund appropriation to the department.

B. State Water Control Board Permit Program Fund. All fees collected in response to this chapter and not deposited into the Sludge Management Fund shall be deposited into the State Water Control Board Permit Program Fund established by, and used and accounted for as specified in § 62.1-44.15:7 of the Code of Virginia. Payment to the Departments of Conservation and Recreation and Game and Inland Fisheries for permit applications they are required under state law to review will be made from this fund. Fees collected shall be exempt from statewide indirect costs charged and collected by the Department of Accounts.

Part III

Determination of Fee Amount

9VAC25-20-100. General.

Each application for a new permit, permit authorization or certificate, each application for reissuance of a permit, permit authorization or certificate, each application for major modification of a permit, permit authorization or certificate, each revocation and reissuance of a permit, permit authorization or certificate, and each application of a dry ton of ~~sewage sludge biosolids~~ is a separate action and shall be assessed a separate fee, as applicable. The fees for each type of permit, permit authorization or certificate that the board has the authority to issue, reissue or modify will be as specified in this part.

9VAC25-20-110. Fee schedules for individual VPDES and VPA new permit issuance, and individual VWP, SWW and GWW new permit issuance and existing permit reissuance.

A. Virginia Pollutant Discharge Elimination System (VPDES) permits. The following fee schedules apply to applications for issuance of a new individual VPDES permit or certificate. (Note: All flows listed in the table below are facility "design" flows.)

VPDES Industrial Major	\$24,000
VPDES Municipal Major	\$21,300
VPDES Municipal Major Stormwater/MS4	\$21,300
VPDES Industrial Minor/No Standard	\$10,200

Regulations

Limits	
VPDES Industrial Minor/Standard Limits	\$3,300
VPDES Industrial Stormwater	\$7,200
VPDES Municipal Minor/Greater Than 100,000 GPD	\$7,500
VPDES Municipal Minor/10,001 GPD-100,000 GPD	\$6,000
VPDES Municipal Minor/1,001 GPD-10,000 GPD	\$5,400
VPDES Municipal Minor/1,000 GPD or less	\$2,000
VPDES Municipal Minor/1,000 GPD or less that includes - The authorization for land application [, distribution, or marketing] of biosolids or land disposal of sewage sludge	\$5,000*
VPDES Municipal Minor Stormwater/MS4	\$2,000

*For a new VPDES permit that includes authorization for land application [, distribution, or marketing] of biosolids or land disposal of sewage sludge, ~~the \$5,000 of the fee will be deposited into the Sludge Management Fund~~ biosolids permit fee will be paid in addition to the required VPDES permit fee.

B. Virginia Pollution Abatement (VPA) permits. The following fee schedules apply to applications for issuance of a new individual VPA permit or certificate. [~~(Note: Land application rates listed in the table below are facility "design" rates.)~~]

VPA Concentrated Animal Feeding Operation	(Reserved)
VPA Intensified Animal Feeding Operation	(Reserved)
VPA Industrial Wastewater Operation/Land Application of 10 or More Inches Per Year	\$15,000
VPA Industrial Wastewater Operation/Land Application of Less Than 10 Inches Per Year	\$10,500
VPA Industrial Sludge Operation	\$7,500
[<u>VPA Combined Sludge Operation - Industrial Sludge (excluding water treatment plant residuals) and Municipal Biosolids</u>]	<u>\$7,500</u>]

VPA Municipal Wastewater Operation	\$13,500
VPA Municipal Sludge Biosolids Operation	\$5,000
All other operations not specified above	\$750

C. Virginia Water Protection (VWP) permits. The following fee schedules apply to applications for issuance of a new individual and reissuance of an existing individual VWP permit or certificate. Only one permit application fee shall be assessed per application; for a permit application involving more than one of the operations described below, the governing fee shall be based upon the primary purpose of the proposed activity. (Note: Withdrawal amounts shown in the table below are maximum daily withdrawals.)

VWP Individual/Surface Water Impacts (Wetlands, Streams and/or Open Water)	\$2,400 plus \$220 for each 4,356 sq. ft. (1/10 acre) (or portion thereof) of incremental impact over 87,120 sq. ft. (two acres) (\$60,000 maximum)
VWP Individual/Minimum Instream Flow - Withdrawals equal to or greater than 3,000,000 gallons on any day	\$25,000
VWP Individual/Minimum Instream Flow - Withdrawals between 2,000,000 and 2,999,999 gallons on any day	\$20,000
VWP Individual/Minimum Instream Flow - Withdrawals between 1,000,000 and 1,999,999 gallons on any day	\$15,000
VWP Individual/Minimum Instream Flow - Withdrawals less than 1,000,000 gallons on any day that do not otherwise qualify for a general VWP permit for water withdrawals	\$10,000
VWP Individual/Reservoir - Major	\$35,000
VWP Individual/Reservoir - Minor	\$25,000
VWP Individual/Nonmetallic Mineral Mining	\$2,400 plus \$220 for each 4,356 sq.

	ft. (1/10 acre) (or portion thereof) of incremental impact over 87,120 sq. ft. (two acres) (\$7,500 maximum)
--	--

9VAC25-20-120. Fee schedules for major modification of individual permits or certificates requested by the permit or certificate holder.

A. The following fee schedules apply to applications for major modification of an individual permit or certificate requested by the permit or certificate holder:

D. Surface Water Withdrawal (SWW) permits or certificates issued in response to Chapter 24 (§ 62.1-242 et seq.) of Title 62.1 of the Code of Virginia. The following fee schedules apply to applications for issuance of a new individual, and reissuance of an existing individual SWW permit or certificate.

Agricultural withdrawal not exceeding 150 million gallons in any single month	(Reserved)
Agricultural withdrawal greater than 150 million gallons but less than 300 million gallons in any single month	(Reserved)
Agricultural withdrawal of 300 million gallons or greater in any single month	(Reserved)
Surface Water Withdrawal	\$12,000

E. [~~Ground Water~~ Groundwater] Withdrawal (GWW) Permits issued in response to Chapter 25 (§ 62.1-254 et seq.) of Title 62.1 of the Code of Virginia. The following fee schedules apply to applications for issuance of a new individual, and reissuance of an existing individual GWW permit or certificate.

Agricultural withdrawal not exceeding 150 million gallons in any single month	(Reserved)
Agricultural withdrawal greater than 150 million gallons but less than 300 million gallons in any single month	(Reserved)
Agricultural withdrawal of 300 million gallons or greater in any single month	(Reserved)
[Ground Water <u>Groundwater</u>] Withdrawal/Initial Permit for an Existing Withdrawal Based Solely on Historic Withdrawals	\$1,200
[Ground Water <u>Groundwater</u>] Withdrawal	\$6,000

1. Virginia Pollutant Discharge Elimination System (VPDES) permits. The application fees listed in the table below apply to a major modification that occurs (and becomes effective) before the stated permit expiration date. [(Note: All flows listed in the table below are facility "design" flows.)]

VPDES Industrial Major	\$12,000
VPDES Municipal Major	\$10,650
VPDES Municipal Major Stormwater/MS4	\$5,150
VPDES Industrial Minor/No Standard Limits	\$5,100
VPDES Industrial Minor/Standard Limits	\$3,300
VPDES Industrial Stormwater	\$3,600
VPDES Municipal Minor/Greater Than 100,000 GPD	\$3,750
VPDES Municipal Minor/10,001 GPD - 100,000 GPD	\$3,000
VPDES Municipal Minor/1,001 GPD - 10,000 GPD	\$2,700
<u>VPDES Municipal - modification relating to the authorization for land application [, distribution, or marketing] of biosolids or land disposal of sewage sludge</u>	<u>\$1,000*</u>
VPDES Municipal Minor/1,000 GPD or Less	\$1,000
VPDES Municipal Minor Stormwater/MS4	\$1,000

*The fee for modification of a VPDES permit due to changes relating to authorization for land application [, distribution, or marketing] of biosolids or land disposal of sewage sludge shall be \$1,000, notwithstanding other modification fees incurred. The modification fee shall apply for [the any] addition of land application sites to a permit [when a public meeting is required as specified in 9VAC25-31-290-12].

2. Virginia Pollution Abatement (VPA) permits. The application fees listed in the table below apply to a major

Regulations

modification that occurs (and becomes effective) before the stated permit expiration date. (Note: Land application rates listed in the table below are facility "design" rates.)

VPA Concentrated Animal Feeding Operation	(Reserved)
VPA Intensified Animal Feeding Operation	(Reserved)
VPA Industrial Wastewater Operation/Land Application of 10 or More Inches Per Year	\$7,500
VPA Industrial Wastewater Operation/Land Application of Less Than 10 Inches Per Year	\$5,250
VPA Industrial Sludge Operation	\$3,750 [¹]
VPA Combined Sludge Operation - Industrial Sludges (excluding water treatment plant residuals) and Municipal Biosolids	\$3,750 ¹]
VPA Municipal Wastewater Operation	\$6,750
VPA Municipal Sludge Biosolids Operation	\$1,000 [¹ / ₂]
All other operations not specified above	\$375

[¹] The modification fee shall apply for [~~the any~~] addition of land application sites to a permit [~~when a public meeting is required as specified in 9VAC25-32-140.C.2~~].

[²When adding any industrial source (excluding water treatment plant residuals) to a permit that only authorizes the land application of municipal biosolids, the modification fee for a VPA combined sludge operation shall apply.]

3. Virginia Water Protection (VWP) permits. (Note: Only one permit application fee shall be assessed per application; for a permit application involving more than one of the operations described below, the governing fee shall be based upon the primary purpose of the proposed activity.)

VWP Individual/Surface Water Impacts (Wetlands, Streams and/or Open Water)	\$1,200 plus \$110 for each 4,356 sq. ft. (1/10 acre) (or portion thereof) of incremental impact over 87,120 sq. ft. (two acres) (\$30,000 maximum)
--	---

VWP Individual/Minimum Instream Flow	\$5,000
VWP Individual/Reservoir (Major or Minor)	\$12,500
VWP Individual/Nonmetallic Mineral Mining	\$1,200 plus \$110 for each 4,356 sq. ft. (1/10 acre) (or portion thereof) of incremental impact over 87,120 sq. ft. (two acres) (\$3,750 maximum)

4. Surface Water Withdrawal (SWW) permits or certificates issued in response to Chapter 24 (§ 62.1-242 et seq.) of Title 62.1 of the Code of Virginia.

Agricultural withdrawal not exceeding 150 million gallons in any single month	(Reserved)
Agricultural withdrawal greater than 150 million gallons but less than 300 million gallons in any single month	(Reserved)
Agricultural withdrawal of 300 million gallons or greater in any single month	(Reserved)
Surface Water Withdrawal	\$6,000

5. [~~Ground Water~~ Groundwater] Withdrawal (GWW) Permits issued in response to Chapter 25 (§ 62.1-254 et seq.) of Title 62.1 of the Code of Virginia.

Agricultural withdrawal not exceeding 150 million gallons in any single month	(Reserved)
Agricultural withdrawal greater than 150 million gallons but less than 300 million gallons in any single month	(Reserved)
Agricultural withdrawal of 300 million gallons or greater in any single month	(Reserved)
[Ground Water Groundwater] Withdrawal/Initial Permit for an Existing Withdrawal Based Solely on Historic Withdrawals	\$600
[Ground Water Groundwater] Withdrawal	\$3,000

[~~B. All rates listed in the tables provided in this section are facility "design" rates unless noted otherwise.~~]

9VAC25-20-142. Permit maintenance fees.

A. The following annual permit maintenance fees apply to each individual VPDES and VPA permit, including expired permits that have been administratively continued, except those exempted by 9VAC25-20-50 B or 9VAC25-20-60 A 4:

1. Base fee rate for Virginia Pollutant Discharge Elimination System (VPDES) permitted facilities. (Note: All flows listed in the table below are facility "design" flows.)

VPDES Industrial Major	\$7,876
VPDES Municipal Major/Greater Than 10 MGD	\$7,794
VPDES Municipal Major/2 MGD - 10 MGD	\$7,138
VPDES Municipal Major/Less Than 2 MGD	\$6,317
VPDES Municipal Major Stormwater/MS4	\$6,235
VPDES Industrial Minor/No Standard Limits	\$3,347
VPDES Industrial Minor/Standard Limits	\$1,969
VPDES Industrial Minor/Water Treatment System	\$1,969
VPDES Industrial Stormwater	\$2,363
VPDES Municipal Minor/Greater Than 100,000 GPD	\$2,461
VPDES Municipal Minor/10,001 GPD - 100,000 GPD	\$1,969
VPDES Municipal Minor/1,001 GPD - 10,000 GPD	\$1,772
VPDES Municipal Minor/1,000 GPD or Less	\$656
VPDES Municipal Major – land application of biosolids or land disposal of sewage sludge	\$1,000*
VPDES Municipal Minor Stormwater/MS4	\$656

~~*The maintenance fee for the authorization of land application of biosolids or land disposal of sewage sludge shall be \$1,000, in addition to the VPDES municipal maintenance fee, if land application of biosolids or land disposal of sewage sludge has occurred in the 12 months preceding the maintenance fee due date.~~

2. Base fee rate for Virginia Pollution Abatement (VPA) permits. [(Note: Land application rates listed in the table below are facility "design" rates.)]

VPA Industrial Wastewater Operation/Land Application of 10 or More Inches Per Year	\$2,461
VPA Industrial Wastewater Operation/Land Application of Less Than 10 Inches Per Year	\$1,723
VPA Industrial Sludge Operation	\$1,231
[VPA Combined Sludge Operation - Industrial Sludges (excluding water treatment plant residuals) and Municipal Biosolids]	<u>\$1,231</u>]
VPA Municipal Wastewater Operation	\$2,215
VPA Municipal Sludge Biosolids Operation	\$1,231 [\$500 <u>\$100</u>]
VPA Concentrated Animal Feeding Operation	(Reserved)
VPA Intensified Animal Feeding Operation	(Reserved)
All other operations not specified above	\$123

3. The amount of the annual permit maintenance fee due from the owner for VPDES and VPA permits for a specified year as required by 9VAC25-20-40 C shall be calculated according to the following formulae:

$$F = B \times C$$

$$C = \frac{1 + \Delta CPI}{215.15}$$

$$\Delta CPI = \frac{CPI - 215.15}{215.15}$$

[where Where]:

F = the permit maintenance fee amount due for the specified calendar year, expressed in dollars.

B = the base fee rate for the type of VPDES or VPA permit from ~~subdivisions~~ subdivision 1 or 2 of this subsection, expressed in dollars.

C = the Consumer Price Index adjustment factor.

ΔCPI = the difference between CPI and 215.15 (the average of the Consumer Price Index values for all-urban consumers for the 12-month period ending on April 30, 2009), expressed as a proportion of 215.15.

CPI = the average of the Consumer Price Index values for all-urban consumers for the 12-month period ending

Regulations

on April 30 of the calendar year before the specified year for which the permit maintenance fee is due. (The Consumer Price Index for all-urban consumers is published by the U.S. Department of Labor, Bureau of Labor Statistics, U.S. All items, CUUR0000SA0).

For example, if calculating the 2010 permit maintenance fee (F) for a VPDES Industrial Major source:

$CPI = 215.15$ (the average of CPI values from May 1, 2008, to April 30, 2009, inclusive would be used for the 2010 permit maintenance fee calculation).

$\Delta CPI = \text{zero}$ for the 2010 permit maintenance fee calculation (i.e., $(CPI - 215.15)/215.15 = (215.15 - 215.15)/215.15 = 0$). (Note: ΔCPI for other years would not be zero.)

$C = 1.0$ for the 2010 permit maintenance fee calculation (i.e., $1 + \Delta CPI = 1 + 0 = 1.0$).

$B = \$7,876$ (i.e. the value for a VPDES Industrial Major source, taken from subdivision 1 of this subsection).

$F = \$7,876$ for the 2010 permit maintenance fee calculation for this VPDES Industrial Major source (i.e., $\$7,876 \times 1.0 = \$7,876$).

4. Permit maintenance fees (F) calculated for each facility shall be rounded to the nearest dollar.

5. The total amount of permit fees collected by the board (permit maintenance fees plus permit application fees) shall not exceed 50% of direct costs for administration, compliance, and enforcement of VPDES and VPA permits. The director shall take whatever action is necessary to ensure that this limit is not exceeded.

B. Additional permit maintenance fees.

1. An additional permit maintenance fee of \$1,000 shall be paid annually by permittees in a toxics management program. Any facility that performs acute or chronic biological testing for compliance with a limit or special condition requiring monitoring in a VPDES permit is included in the toxics management program.

2. An additional permit maintenance fee of \$1,000 shall be paid annually by permittees that have more than five process wastewater discharge outfalls at a single facility (not including "internal" outfalls).

3. For a local government or public service authority with permits for multiple facilities in a single jurisdiction, the total permit maintenance fees for all permits held as of April 1, 2004, shall not exceed \$32,818 per year.

C. If the category of a facility (~~as described in 9VAC25-20-142 A 1 or 2~~) (as described in subdivision A 1 or A 2 of this section) changes as the result of a permit modification, the permit maintenance fee based upon the permit category as of April 1 shall be submitted by October 1.

D. Annual permit maintenance fees may be discounted for participants in the Environmental Excellence Program as described in 9VAC25-20-145.

Part IV

~~Sewage Sludge~~ Biosolids Fees and Reimbursable Costs

9VAC25-20-146. Established fees.

A. Land applicers shall remit the established fees to the department as specified in this regulation. The land applicers shall collect the required fees from the owners of the sewage treatment works and facilities that generate the biosolids. Such works and facilities shall be approved sources of biosolids in accordance with this regulation. Land application shall only include biosolids from approved sources as listed in the land application permit. The established fee shall be imposed on each dry ton of biosolids that is land applied in the Commonwealth of Virginia in accordance with 9VAC25-31 or 9VAC25-32.

B. The amount of the established fee and disbursement are as follows:

1. The fee shall be \$7.50 per dry ton of biosolids land applied in the Commonwealth of Virginia.

2. Disbursement of the established fees collected by the department shall be made to reimburse or partially reimburse those counties, cities and towns with duly adopted local ordinances that submit documentation of reimbursable expenses acceptable to the department as provided for in this regulation.

3. Disbursement of the established fees collected by the department shall be made to reimburse the Department of Conservation and Recreation's costs for implementation of the ~~sewage sludge~~ biosolids application program.

9VAC25-20-147. Records and reports.

A. Records. Permittees shall maintain complete records of the land application activities and amounts of biosolids that they land apply in the Commonwealth of Virginia. Such records shall be maintained by the permittee for five years after the date of the activity in a form that is available for inspection by the department ~~for five years after the date of the activity~~. Records of land application activities shall include ~~the following~~ at minimum information:

1. Name of permittee, DEQ permit number, and dates of activity.

2. Identification of land application site, including the ~~county where taxes are remitted and permitted site identification name, letters and numbers, as appropriate~~ DEQ control number.

3. The source of biosolids and ~~approximate~~ field area receiving those biosolids.

4. The amount of biosolids applied in dry tons and the method and calculations used to determine the reported value.

~~5. Dates and type of any interactions with local monitors and names of individuals involved in the interactions.~~

~~6.~~ 5. Name of responsible representative of permittee and a statement signed and dated by that representative

indicating that the information submitted has been verified by that representative as correctly reported in accordance with this regulation.

B. Reports and notification. The permittee shall submit a monthly report by the 15th day of [~~the~~ each] month [~~following the month that land application occurs for land application activity that occurred in the previous calendar month~~], unless another date is specified in the permit in accordance with 9VAC25-32-80 I 4, ~~following the month that land application occurs~~. ~~That~~ The report shall include (i) the recorded information listed in subsection A of this section and ~~present~~ (ii) a calculation of the total fee ~~that is required in accordance with this regulation~~. The submitted report shall include a summary list of the total amount of biosolids applied and the calculated fee based on the land-applied biosolids for each county in which land application occurred ~~in alphabetical order by county~~. [~~If no land application occurs under a permit during the calendar month, a report shall be submitted stating that no land application occurred.~~]

9VAC25-20-148. Reimbursable local monitoring costs.

~~The following describes the kinds of activities for which expenses may, if reasonable,~~ A. Reasonable expenses for the following types of activities may be submitted for reimbursement:

1. Charges for reviewing the permit to identify potential health and environmental protection issues upon notification by the permittee that operations will be initiated on permitted sites.
2. Charges and expenses, including local travel for site monitoring, inspections, collection and delivery of biosolids or soil samples to a nearby laboratory and examination of records.
3. Charges for recordkeeping.
4. Charges for complaint and incident response.
5. Charges for biosolids and soil sample testing costs.
6. Charges for the training of local monitors.

B. Charges for site monitoring not associated with determining compliance with state or federal law or regulation are ineligible for reimbursement.

9VAC25-20-149. Reimbursement of local monitoring costs.

A. Reimbursement of local monitoring costs deemed reasonable by the department will be made in order of receipt of an acceptable invoice. Such invoices will be reimbursed for reasonable costs up to \$2.50, as adjusted, per dry ton of biosolids land applied in a county during the period of time specified in the submitted invoice. If sufficient revenue exists from the fees collected monthly, then invoiced claims exceeding \$2.50, as adjusted, per dry ton of biosolids land applied in that county, during the period of time specified in the submitted invoice, may be released for reimbursement Costs of up to \$4.00 per dry ton of biosolids land applied in

~~that a county during the month period of time that the reimbursable costs were incurred, based on the order of receipt of the invoice may be reimbursed with prior approval from the department.~~

~~A. B. Application.~~ A local government must submit a reimbursement application to request reimbursement from the department. All information ~~is to~~ shall be clearly typed or printed and all required or supporting documents must be attached. The county administrator or designated local biosolids monitor shall sign and date the application where indicated. The original signed application with one copy of each of the supporting documents ~~is to~~ shall be [~~forwarded~~ submitted] to the department. Applications may not be submitted by facsimile or through electronic means. A reimbursement invoice form as described in this regulation must be completed before a reimbursement application can be submitted. The invoice form must include all expenses for which reimbursement is requested during the designated time period.

~~B. C. Application forms and submittal.~~ The application for reimbursement must be submitted within 30 days of the last day of the month in which the reimbursable activity occurred. All applications received after this time frame will be ineligible for reimbursement. The following is a description of the application forms and an explanation of their use. The application forms and detailed instructions can be obtained from the department.

1. Form 1 - Reimbursement Application. An invoice form shall be submitted with each application for reimbursement. The invoice form ~~should~~ shall list all reimbursable charges. To be reimbursed for eligible expenses, an applicant must provide documentation to demonstrate that the expenses were incurred. Invoices are acceptable proof of incurred expenses. ~~Include legible copies of invoices~~ Invoices signed by the local biosolids monitor or agent who performed or managed the monitoring activities shall be legible. All invoices are to include the following:

- a. DEQ permit number and site identification;
- b. ~~Number or site address~~ DEQ control number for application fields;
- c. Biosolids contractor's name;
- d. Date and type of activity monitored;
- e. Name of biosolids monitor;
- f. Number of hours to be reimbursed and charge per hour;
- g. List of expenses for which reimbursement is sought; [and]
- h. Type of sampling activity performed and associated laboratory expense vouchers.

2. The application requires the county administrator to certify that the responsible official has read and

Regulations

understands the requirements for reimbursement and that the application submitted is not fraudulent. The local monitor must attest to the accuracy and completeness of the information provided.

~~2.~~ 3. Form 2 - Multiple Owners Payment Assignment Form. When there are multiple local governments as claimants, a separate, signed and notarized invoice form for each claimant must be filled out and submitted with the application.

~~Submittal of the original completed reimbursement application, including the application worksheets and the appropriate supporting documentation, should be accomplished by mailing these documents to: Department of Environmental Quality, Receipts Control, P.O. Box 1105, Richmond, VA 23218.~~

~~C.~~ D. Processing applications.

1. If contacted by the department regarding an incomplete reimbursement application, an applicant will have 14 days from the date of the call or letter to submit the information requested and ~~are correct~~ any deficiencies. Extensions of the 14-day deadline will not be granted. An application that does not contain all of the required information after the 14-day time frame may be rejected ~~or processed "as is," which can result in complete denial or a partial reimbursement.~~

2. Only invoices pertaining to the monitoring activity claimed in the current application will be accepted. Costs omitted from previous claims are ineligible for reimbursement in subsequent claims. ~~Likewise, invoices~~ Invoices submitted in previous claims ~~will are~~ not be eligible documentation for reimbursement of costs in subsequent claims. To reduce the risk of disqualification of costs, costs for different monitoring activities should be invoiced separately. If possible, invoices should be structured so that costs are grouped according to task or activity.

~~D.~~ E. Reconsideration process.

1. Claimants may submit a written response indicating why they believe costs denied on the reimbursement decision should be paid.

2. If the claimant disagrees with the decision in the reimbursement payment package, a notice of intent (NOI) to object and a reconsideration claim form must be submitted to the department within the filing deadlines specified in the reconsideration procedure package

a. If filing deadlines are not met, the decision in the reimbursement payment package is final. This written objection ~~is to~~ shall be in the format specified in the reconsideration procedure package and explain the reasons for disagreement with the decisions in the reimbursement payment letter and supply any additional supporting documentation.

b. Upon receipt of this information and at the claimant's request, the department may schedule a reconsideration meeting to reevaluate the denied costs.

3. Claimants will be given an opportunity to contest the reimbursement decisions in accordance with the Administrative Process Act (§ 2.2-4000 et seq. of the Code of Virginia). Within the filing deadline, the claimant must submit a written summary of the issues that will be contested using the reconsideration claim form.

4. The reconsideration procedures provide the department the opportunity to correct certain errors. ~~The following types of errors can be corrected~~ as follows:

a. Failure of the reviewer to verify an invoice form that was received prior to completing the verification package for the reimbursement.

b. Errors the reviewer makes in verifying an invoice form.

c. Failure of the claimant to submit all invoices.

5. Errors ineligible for reconsideration. Notwithstanding the above, some types of errors cannot be corrected using the reconsideration process. It is the responsibility of the claimant or consultant, or both, to ensure that all application forms (invoice forms, and sampling and testing verification) are ~~completely and accurately filled out~~ complete and accurate. ~~Failure to exercise proper care in preparing an application~~ The following types of errors may result in a denial of costs, which cannot be corrected through the reconsideration process, including:

a. Items omitted from the invoice ~~form will not be~~ eligible for reimbursement;

b. Unverified sampling and testing results ~~will not be~~ eligible for reimbursement;

c. ~~No additions~~ Additions or revisions to the invoice forms ~~will be accepted from the claimant submitted~~ after the reviewer forwards the verification package to the department;

d. Using one invoice in multiple claims. Invoices submitted in an application cannot be used as documentation for reimbursement of costs in subsequent claims;

e. ~~The following are types of errors that cannot be corrected:~~

(1) ~~e.~~ Failure to claim performed work on the invoice form;

(2) ~~f.~~ Failure to claim sampling and testing costs as authorized; or

(3) ~~Failure to claim all costs in a submitted invoice.~~

(4) ~~Failure to submit to the reviewer all supporting documentation to demonstrate the necessity of work performed that exceeds expected activities. Such documentation must be submitted before the reviewer forwards the verification package to the department.~~

g. Failure to obtain prior approval from the department for costs that exceed \$2.50 per dry ton of biosolids land applied.

NOTICE: The following forms used in administering the regulation were filed by the agency. The forms are not being published; however, online users of this issue of the Virginia Register of Regulations may click on the name to access a form. The forms are also available from the agency contact or may be viewed at the Office of the Registrar of Regulations, General Assembly Building, 2nd Floor, Richmond, Virginia 23219.

FORMS (9VAC25-20)

~~[DEQ Water Division Permit Application Fee Form Effective January 1, 2008 (rev. 1/10).~~

~~Form 1 Biosolids Land Application Local Monitoring Expenses Reimbursement Invoice (rev. 5/10).~~

~~Form 2 Biosolids Land Application Fee Reimbursement Multiple Owners Payment Assignment (2007).~~

~~Form 3 Biosolids Land Application Fee Reimbursement Notice of Intent to Seek Reconsideration (rev. 8/07).~~

~~Form 4 Biosolids Land Application Fee Reimbursement Reconsideration Claim Form (rev. 8/07).~~

[Department of Environmental Quality Water Division Permit Application Fee Form Effective January 1, 2008 \(rev. 5/13\).](#)

[Biosolids Land Application Local Monitoring Expenses Reimbursement Invoice, Form 1 \(rev. 6/13\).](#)

[Biosolids Land Application Local Monitoring Expenses Multiple Owners Payment Assignment, Form 2 \(rev. 6/13\).](#)

[Biosolids Land Application Fee Reimbursement Notice of Intent to Seek Reconsideration, Form 3 \(rev. 8/07\).](#)

[Biosolids Land Application Fee Reimbursement Reconsideration Claim Form, Form 4 \(rev. 8/07\). \]](#)

Part I

Definitions and General Program Requirements

9VAC25-31-10. Definitions.

"Act" means Federal Water Pollution Control Act, also known as the Clean Water Act [CWA], as amended, 33 USC § 1251 et seq.

"Administrator" means the Administrator of the United States Environmental Protection Agency, or an authorized representative.

"Animal feeding operation" or "AFO" means a lot or facility (other than an aquatic animal production facility) where the following conditions are met: (i) animals (other than aquatic animals) have been, are, or will be stabled or confined and fed or maintained for a total of 45 days or more in any 12-month period, and (ii) crops, vegetation forage growth, or post-harvest residues are not sustained in the normal growing season over any portion of the lot or facility.

"Applicable standards and limitations" means all state, interstate, and federal standards and limitations to which a discharge, a sewage sludge use or disposal practice, or a related activity is subject under the [Clean Water Act (CWA) CWA] (33 USC § 1251 et seq.) and the law, including effluent limitations, water quality standards, standards of performance, toxic effluent standards or prohibitions, best management practices, pretreatment standards, and standards for [biosolids use or] sewage sludge [use or] disposal under §§ 301, 302, 303, 304, 306, 307, 308, 403 and 405 of CWA.

"Approval authority" means the Director of the Department of Environmental Quality.

"Approved POTW Pretreatment Program" or "Program" or "POTW Pretreatment Program" means a program administered by a POTW that meets the criteria established in Part VII (9VAC25-31-730 et seq.) of this chapter and which has been approved by the director or by the administrator in accordance with 9VAC25-31-830.

"Approved program" or "approved state" means a state or interstate program which has been approved or authorized by EPA under 40 CFR Part 123.

"Aquaculture project" means a defined managed water area which uses discharges of pollutants into that designated area for the maintenance or production of harvestable freshwater, estuarine, or marine plants or animals.

"Average monthly discharge limitation" means the highest allowable average of daily discharges over a calendar month, calculated as the sum of all daily discharges measured during a calendar month divided by the number of daily discharges measured during that month.

"Average weekly discharge limitation" means the highest allowable average of daily discharges over a calendar week, calculated as the sum of all daily discharges measured during a calendar week divided by the number of daily discharges measured during that week.

"Best management practices (BMPs)" means schedules of activities, prohibitions of practices, maintenance procedures, and other management practices to implement the prohibitions listed in 9VAC25-31-770 and to prevent or reduce the pollution of surface waters. BMPs also include treatment requirements, operating procedures, and practices to control plant site run-off, spillage or leaks, sludge or waste disposal, or drainage from raw material storage.

["Biosolids" means a sewage sludge that has received an established treatment and is managed in a manner to meet the required pathogen control and vector attraction reduction, and contains concentrations of regulated pollutants below the ceiling limits established in 40 CFR Part 503 and 9VAC25-31-540, such that it meets the standards established for use of biosolids for land application, marketing, or distribution in accordance with this chapter. Liquid biosolids contains less than 15% dry residue by weight. Dewatered biosolids contains 15% or more dry residue by weight.]

Regulations

"Board" means the Virginia State Water Control Board or State Water Control Board.

"Bypass" means the intentional diversion of waste streams from any portion of a treatment facility.

"Class I sludge management facility" means any POTW identified under Part VII (9VAC25-31-730 et seq.) of this chapter as being required to have an approved pretreatment program and any other treatment works treating domestic sewage classified as a Class I sludge management facility by the regional administrator, in conjunction with the director, because of the potential for its sludge use or disposal practices to adversely affect public health and the environment.

"Concentrated animal feeding operation" or "CAFO" means an AFO that is defined as a Large CAFO or as a Medium CAFO, or that is designated as a Medium CAFO or a Small CAFO. Any AFO may be designated as a CAFO by the director in accordance with the provisions of 9VAC25-31-130 B.

1. "Large CAFO." An AFO is defined as a Large CAFO if it stables or confines as many or more than the numbers of animals specified in any of the following categories:

- a. 700 mature dairy cows, whether milked or dry;
- b. 1,000 veal calves;
- c. 1,000 cattle other than mature dairy cows or veal calves. Cattle includes but is not limited to heifers, steers, bulls and cow/calf pairs;
- d. 2,500 swine each weighing 55 pounds or more;
- e. 10,000 swine each weighing less than 55 pounds;
- f. 500 horses;
- g. 10,000 sheep or lambs;
- h. 55,000 turkeys;
- i. 30,000 laying hens or broilers, if the AFO uses a liquid manure handling system;
- j. 125,000 chickens (other than laying hens), if the AFO uses other than a liquid manure handling system;
- k. 82,000 laying hens, if the AFO uses other than a liquid manure handling system;
- l. 30,000 ducks, if the AFO uses other than a liquid manure handling system; or
- m. 5,000 ducks if the AFO uses a liquid manure handling system.

2. "Medium CAFO." The term Medium CAFO includes any AFO with the type and number of animals that fall within any of the ranges below that has been defined or designated as a CAFO. An AFO is defined as a Medium CAFO if:

- a. The type and number of animals that it stables or confines falls within any of the following ranges:

- (1) 200 to 699 mature dairy cattle, whether milked or dry;
- (2) 300 to 999 veal calves;
- (3) 300 to 999 cattle other than mature dairy cows or veal calves. Cattle includes but is not limited to heifers, steers, bulls and cow/calf pairs;
- (4) 750 to 2,499 swine each weighing 55 pounds or more;
- (5) 3,000 to 9,999 swine each weighing less than 55 pounds;
- (6) 150 to 499 horses;
- (7) 3,000 to 9,999 sheep or lambs;
- (8) 16,500 to 29,999 laying hens or broilers, if the AFO uses a liquid manure handling system;
- (9) 37,500 to 124,999 chickens (other than laying hens), if the AFO uses other than a liquid manure handling system;
- (10) 25,000 to 81,999 laying hens, if the AFO uses other than a liquid manure handling system;
- (11) 10,000 to 29,999 ducks, if the AFO uses other than a liquid manure handling system;
- (12) 1,500 to 4,999 ducks, if the AFO uses a liquid manure handling system; and

b. Either one of the following conditions are met:

- (1) Pollutants are discharged into surface waters of the state through a manmade ditch, flushing system, or other similar manmade device; or
- (2) Pollutants are discharged directly into surface waters of the state that originate outside of and pass over, across, or through the facility or otherwise come into direct contact with the animals confined in the operation.

3. "Small CAFO." An AFO that is designated as a CAFO and is not a Medium CAFO.

"Concentrated aquatic animal production facility" means a hatchery, fish farm, or other facility which meets the criteria of this definition, or which the board designates under 9VAC25-31-140. A hatchery, fish farm, or other facility is a concentrated aquatic animal production facility if it contains, grows, or holds aquatic animals in either of the following categories:

1. Cold water fish species or other cold water aquatic animals in ponds, raceways, or other similar structures which discharge at least 30 days per year but does not include:
 - a. Facilities which produce less than 9,090 harvest weight kilograms (approximately 20,000 pounds) of aquatic animals per year; and
 - b. Facilities which feed less than 2,272 kilograms (approximately 5,000 pounds) of food during the calendar month of maximum feeding; or

2. Warm water fish species or other warm water aquatic animals in ponds, raceways, or other similar structures which discharge at least 30 days per year, but does not include:

- a. Closed ponds which discharge only during periods of excess run-off; or
- b. Facilities which produce less than 45,454 harvest weight kilograms (approximately 100,000 pounds) of aquatic animals per year.

Cold water aquatic animals include, but are not limited to, the Salmonidae family of fish (e.g., trout and salmon).

Warm water aquatic animals include, but are not limited to, the Ictaluridae, Centrarchidae and Cyprinidae families of fish (e.g., respectively, catfish, sunfish and minnows).

"Contiguous zone" means the entire zone established by the United States under Article 24 of the Convention on the Territorial Sea and the Contiguous Zone (37 FR 11906).

"Continuous discharge" means a discharge which occurs without interruption throughout the operating hours of the facility, except for infrequent shutdowns for maintenance, process changes, or other similar activities.

"Control authority" refers to the POTW if the POTW's pretreatment program submission has been approved in accordance with the requirements of 9VAC25-31-830 or the approval authority if the submission has not been approved.

"Co-permittee" means a permittee to a VPDES permit that is only responsible for permit conditions relating to the discharge for which it is the operator.

"CWA" means the Clean Water Act (33 USC § 1251 et seq.) (formerly referred to as the Federal Water Pollution Control Act or Federal Water Pollution Control Act Amendments of 1972) Public Law 92-500, as amended by Public Law 95-217, Public Law 95-576, Public Law 96-483, [~~and~~] Public Law 97-117 [, and Public Law 100-4].

"CWA and regulations" means the Clean Water Act (CWA) and applicable regulations promulgated thereunder. For the purposes of this chapter, it includes state program requirements.

"Daily discharge" means the discharge of a pollutant measured during a calendar day or any 24-hour period that reasonably represents the calendar day for purposes of sampling. For pollutants with limitations expressed in units of mass, the daily discharge is calculated as the total mass of the pollutant discharged over the day. For pollutants with limitations expressed in other units of measurement, the daily discharge is calculated as the average measurement of the pollutant over the day.

"Department" means the Virginia Department of Environmental Quality.

"Designated project area" means the portions of surface within which the permittee or permit applicant plans to confine the cultivated species, using a method or plan or

operation (including, but not limited to, physical confinement) which, on the basis of reliable scientific evidence, is expected to ensure that specific individual organisms comprising an aquaculture crop will enjoy increased growth attributable to the discharge of pollutants, and be harvested within a defined geographic area.

"Direct discharge" means the discharge of a pollutant.

"Director" means the Director of the Department of Environmental Quality or an authorized representative.

"Discharge," when used without qualification, means the discharge of a pollutant.

"Discharge," when used in Part VII (9VAC25-31-730 et seq.) of this chapter, means "indirect discharge" as defined in this section.

"Discharge of a pollutant" means:

1. Any addition of any pollutant or combination of pollutants to surface waters from any point source; or
2. Any addition of any pollutant or combination of pollutants to the waters of the contiguous zone or the ocean from any point source other than a vessel or other floating craft which is being used as a means of transportation.

This definition includes additions of pollutants into surface waters from: surface run-off which is collected or channeled by man; discharges through pipes, sewers, or other conveyances owned by a state, municipality, or other person which do not lead to a treatment works; and discharges through pipes, sewers, or other conveyances, leading into privately owned treatment works. This term does not include an addition of pollutants by any indirect discharger.

"Discharge Monitoring Report (DMR)" means the form supplied by the department or an equivalent form developed by the permittee and approved by the board, for the reporting of self-monitoring results by permittees.

"Draft permit" means a document indicating the board's tentative decision to issue or deny, modify, revoke and reissue, terminate, or reissue a permit. A notice of intent to terminate a permit, and a notice of intent to deny a permit are types of draft permits. A denial of a request for modification, revocation and reissuance, or termination is not a draft permit. A proposed permit is not a draft permit.

"Effluent limitation" means any restriction imposed by the board on quantities, discharge rates, and concentrations of pollutants which are discharged from point sources into surface waters, the waters of the contiguous zone, or the ocean.

"Effluent limitations guidelines" means a regulation published by the administrator under § 304(b) of the CWA to adopt or revise effluent limitations.

"Environmental Protection Agency (EPA)" means the United States Environmental Protection Agency.

"Existing source" means any source which is not a new source or a new discharger.

Regulations

"Facilities or equipment" means buildings, structures, process or production equipment or machinery which form a permanent part of a new source and which will be used in its operation, if these facilities or equipment are of such value as to represent a substantial commitment to construct. It excludes facilities or equipment used in connection with feasibility, engineering, and design studies regarding the new source or water pollution treatment for the new source.

"Facility or activity" means any VPDES point source or treatment works treating domestic sewage or any other facility or activity (including land or appurtenances thereto) that is subject to regulation under the VPDES program.

"General permit" means a VPDES permit authorizing a category of discharges under the CWA and the law within a geographical area.

"Hazardous substance" means any substance designated under the Code of Virginia and 40 CFR Part 116 pursuant to § 311 of the CWA.

"Incorporated place" means a city, town, township, or village that is incorporated under the Code of Virginia.

"Indian country" means (i) all land within the limits of any Indian reservation under the jurisdiction of the United States government, notwithstanding the issuance of any patent, and including rights-of-way running through the reservation; (ii) all dependent Indian communities with the borders of the United States whether within the originally or subsequently acquired territory thereof, and whether within or without the limits of a state; and (iii) all Indian allotments, the Indian titles to which have not been extinguished, including rights-of-way running through the same.

"Indirect discharge" means the introduction of pollutants into a POTW from any nondomestic source regulated under § 307(b), (c) or (d) of the CWA and the law.

"Indirect discharger" means a nondomestic discharger introducing pollutants to a POTW.

"Individual control strategy" means a final VPDES permit with supporting documentation showing that effluent limits are consistent with an approved wasteload allocation or other documentation that shows that applicable water quality standards will be met not later than three years after the individual control strategy is established.

"Industrial user" or "user" means a source of indirect discharge.

"Interference" means an indirect discharge which, alone or in conjunction with an indirect discharge or discharges from other sources, both: (i) inhibits or disrupts the POTW, its treatment processes or operations, or its sludge processes, use or disposal; and therefore (ii) is a cause of a violation of any requirement of the POTW's VPDES permit (including an increase in the magnitude or duration of a violation) or of the prevention of biosolids use or sewage sludge use or disposal in compliance with the following statutory provisions and regulations or permits issued thereunder (or more stringent

state or local regulations): Section 405 of the Clean Water Act, the Solid Waste Disposal Act (SWDA) (including Title II, more commonly referred to as the Resource Conservation and Recovery Act (RCRA) (42 USC § 6901 et seq.), and including state regulations contained in any state sludge management plan prepared pursuant to Subtitle D of the SWDA) the Clean Air Act (42 USC § 701 et seq.), the Toxic Substances Control Act (15 USC § 2601 et seq.), and the Marine Protection, Research and Sanctuaries Act (33 USC § 1401 et seq.).

"Interstate agency" means an agency of two or more states established by or under an agreement or compact approved by Congress, or any other agency of two or more states having substantial powers or duties pertaining to the control of pollution as determined and approved by the administrator under the CWA and regulations.

"Land application area" means [, in regard to an AFO,] land under the control of an AFO owner or operator, that is owned, rented, or leased to which manure, litter or process wastewater from the production area may be applied.

["Land application area" means, in regard to biosolids, the area in the permitted field, excluding the setback area, where biosolids may be applied.]

"Log sorting" and "log storage facilities" means facilities whose discharges result from the holding of unprocessed wood, for example, logs or roundwood with bark or after removal of bark held in self-contained bodies of water (mill ponds or log ponds) or stored on land where water is applied intentionally on the logs (wet decking).

"Major facility" means any VPDES facility or activity classified as such by the regional administrator in conjunction with the board.

["Malodor" means an unusually strong or offensive odor associated with biosolids or sewage sludge as distinguished from odors normally associated with biosolids or sewage sludge.]

"Manmade" means constructed by man and used for the purpose of transporting wastes.

"Manure" means manure, bedding, compost and raw materials or other materials commingled with manure or set aside for disposal.

"Maximum daily discharge limitation" means the highest allowable daily discharge.

"Municipality" means a city, town, county, district, association, or other public body created by or under state law and having jurisdiction over disposal of sewage, industrial wastes, or other wastes, or an Indian tribe or an authorized Indian tribal organization, or a designated and approved management agency under § 208 of the CWA.

"National Pollutant Discharge Elimination ~~System~~ (NPDES)" System" or "NPDES" means the national program for issuing, modifying, revoking and reissuing, terminating, monitoring and enforcing permits, and imposing and

enforcing pretreatment requirements under §§ 307, 402, 318, and 405 of the CWA. The term includes an approved program.

"National pretreatment standard," "pretreatment standard," or "standard," when used in Part VII (9VAC25-31-730 et seq.) of this chapter, means any regulation containing pollutant discharge limits promulgated by the EPA in accordance with § 307(b) and (c) of the CWA, which applies to industrial users. This term includes prohibitive discharge limits established pursuant to 9VAC25-31-770.

"New discharger" means any building, structure, facility, or installation:

1. From which there is or may be a discharge of pollutants;
2. That did not commence the discharge of pollutants at a particular site prior to August 13, 1979;
3. Which is not a new source; and
4. Which has never received a finally effective VPDES permit for discharges at that site.

This definition includes an indirect discharger which commences discharging into surface waters after August 13, 1979. It also includes any existing mobile point source (other than an offshore or coastal oil and gas exploratory drilling rig or a coastal oil and gas developmental drilling rig) such as a seafood processing rig, seafood processing vessel, or aggregate plant, that begins discharging at a site for which it does not have a permit; and any offshore or coastal mobile oil and gas exploratory drilling rig or coastal mobile oil and gas developmental drilling rig that commences the discharge of pollutants after August 13, 1979.

"New source," except when used in Part VII of this chapter, means any building, structure, facility, or installation from which there is or may be a discharge of pollutants, the construction of which commenced:

- (a) After promulgation of standards of performance under § 306 of the CWA which are applicable to such source; or
- (b) After proposal of standards of performance in accordance with § 306 of the CWA which are applicable to such source, but only if the standards are promulgated in accordance with § 306 of the CWA within 120 days of their proposal.

"New source," when used in Part VII of this chapter, means any building, structure, facility, or installation from which there is or may be a discharge of pollutants, the construction of which commenced after the publication of proposed pretreatment standards under § 307(c) of the CWA which will be applicable to such source if such standards are thereafter promulgated in accordance with that section, provided that:

1. a. The building, structure, facility or installation is constructed at a site at which no other source is located;

b. The building, structure, facility, or installation totally replaces the process or production equipment that causes the discharge of pollutants at an existing source; or

c. The production of wastewater generating processes of the building, structure, facility, or installation are substantially independent of an existing source at the same site. In determining whether these are substantially independent, factors such as the extent to which the new facility is integrated with the existing plant, and the extent to which the new facility is engaged in the same general type of activity as the existing source should be considered.

2. Construction on a site at which an existing source is located results in a modification rather than a new source if the construction does not create a new building, structure, facility, or installation meeting the criteria of subdivision 1 b or c of this definition but otherwise alters, replaces, or adds to existing process or production equipment.

3. Construction of a new source as defined under this subdivision has commenced if the owner or operator has:

a. Begun, or caused to begin, as part of a continuous on-site construction program:

- (1) Any placement, assembly, or installation of facilities or equipment; or
- (2) Significant site preparation work including clearing, excavation, or removal of existing buildings, structures, or facilities which is necessary for the placement, assembly, or installation of new source facilities or equipment; or

b. Entered into a binding contractual obligation for the purchase of facilities or equipment which are intended to be used in its operation within a reasonable time. Options to purchase or contracts which can be terminated or modified without substantial loss, and contracts for feasibility, engineering, and design studies do not constitute a contractual obligation under this subdivision.

"Overburden" means any material of any nature, consolidated or unconsolidated, that overlies a mineral deposit, excluding topsoil or similar naturally occurring surface materials that are not disturbed by mining operations.

"Owner" means the Commonwealth or any of its political subdivisions including, but not limited to, sanitation district commissions and authorities, and any public or private institution, corporation, association, firm or company organized or existing under the laws of this or any other state or country, or any officer or agency of the United States, or any person or group of persons acting individually or as a group that owns, operates, charters, rents, or otherwise exercises control over or is responsible for any actual or potential discharge of sewage, industrial wastes, or other wastes to state waters, or any facility or operation that has the capability to alter the physical, chemical, or biological

Regulations

properties of state waters in contravention of § 62.1-44.5 of the Code of Virginia.

"Owner" or "operator" means the owner or operator of any facility or activity subject to regulation under the VPDES program.

"Pass through" means a discharge which exits the POTW into state waters in quantities or concentrations which, alone or in conjunction with a discharge or discharges from other sources, is a cause of a violation of any requirement of the POTW's VPDES permit (including an increase in the magnitude or duration of a violation).

"Permit" means an authorization, certificate, license, or equivalent control document issued by the board to implement the requirements of this chapter. Permit includes a VPDES general permit. Permit does not include any permit which has not yet been the subject of final agency action, such as a draft permit or a proposed permit.

"Person" means an individual, corporation, partnership, association, a governmental body, a municipal corporation, or any other legal entity.

"Point source" means any discernible, confined, and discrete conveyance including, but not limited to, any pipe, ditch, channel, tunnel, conduit, well, discrete fissure, container, rolling stock, concentrated animal feeding operation, landfill leachate collection system, vessel, or other floating craft from which pollutants are or may be discharged. This term does not include return flows from irrigated agriculture or agricultural storm water run-off.

"Pollutant" means dredged spoil, solid waste, incinerator residue, filter backwash, sewage, garbage, sewage sludge, munitions, chemical wastes, biological materials, radioactive materials (except those regulated under the Atomic Energy Act of 1954, as amended (42 USC § 2011 et seq.)), heat, wrecked or discarded equipment, rock, sand, cellar dirt and industrial, municipal, and agricultural waste discharged into water. It does not mean:

1. Sewage from vessels; or
2. Water, gas, or other material which is injected into a well to facilitate production of oil or gas, or water derived in association with oil and gas production and disposed of in a well if the well used either to facilitate production or for disposal purposes is approved by the board, and if the board determines that the injection or disposal will not result in the degradation of ground or surface water resources.

~~["Publicly owned treatment works" or "POTW" means a treatment works as defined by § 212 of the Act, which is owned by a state or municipality (as defined by § 502(4) of the Act). This definition includes any devices and systems used in the storage, treatment, recycling and reclamation of municipal sewage or industrial wastes of a liquid nature. It also includes sewers, pipes and other conveyances only if they convey wastewater to a POTW treatment plant. The term~~

~~also means the municipality as defined in § 502(4) of the Act, which has jurisdiction over the indirect discharges to and the discharges from such a treatment works.]~~

"POTW treatment plant" means that portion of the POTW which is designed to provide treatment (including recycling and reclamation) of municipal sewage and industrial waste.

"Pretreatment" means the reduction of the amount of pollutants, the elimination of pollutants, or the alteration of the nature of pollutant properties in wastewater prior to or in lieu of discharging or otherwise introducing such pollutants into a POTW. The reduction or alteration may be obtained by physical, chemical or biological processes, process changes or by other means, except as prohibited in Part VII of this chapter. Appropriate pretreatment technology includes control equipment, such as equalization tanks or facilities, for protection against surges or slug loadings that might interfere with or otherwise be incompatible with the POTW. However, where wastewater from a regulated process is mixed in an equalization facility with unregulated wastewater or with wastewater from another regulated process, the effluent from the equalization facility must meet an adjusted pretreatment limit calculated in accordance with Part VII of this chapter.

"Pretreatment requirements" means any requirements arising under Part VII of this chapter including the duty to allow or carry out inspections, entry or monitoring activities; any rules, regulations, or orders issued by the owner of a publicly owned treatment works; or any reporting requirements imposed by the owner of a publicly owned treatment works or by the regulations of the board. Pretreatment requirements do not include the requirements of a national pretreatment standard.

"Primary industry category" means any industry category listed in the NRDC settlement agreement (Natural Resources Defense Council et al. v. Train, 8 E.R.C. 2120 (D.D.C. 1976), modified 12 E.R.C. 1833 (D.D.C. 1979)); also listed in 40 CFR Part 122 Appendix A.

"Privately owned treatment works (PVOTW)" means any device or system which is (i) used to treat wastes from any facility whose operator is not the operator of the treatment works and (ii) not a POTW.

"Process wastewater" means any water which, during manufacturing or processing, comes into direct contact with or results from the production or use of any raw material, intermediate product, finished product, byproduct, or waste product. Process wastewater from an AFO means water directly or indirectly used in the operation of the AFO for any of the following: spillage or overflow from animal or poultry watering systems; washing, cleaning, or flushing pens, barns, manure pits, or other AFO facilities; direct contact swimming, washing, or spray cooling of the animals; or dust control. Process wastewater from an AFO also includes any water that comes into contact with any raw materials, products, or byproducts including manure, litter, feed, milk, eggs or bedding.

"Production area" means that part of an AFO that includes the animal confinement area, the manure storage area, the raw materials storage area, and the waste containment areas. The animal confinement area includes but is not limited to open lots, housed lots, feedlots, confinement houses, stall barns, free stall barns, milkrooms, milking centers, cowyards, barnyards, medication pens, walkers, animal walkways, and stables. The manure storage area includes but is not limited to lagoons, runoff ponds, storage sheds, stockpiles, under house or pit storages, liquid impoundments, static piles, and composting piles. The raw materials storage areas includes but is not limited to feed silos, silage bunkers, and bedding materials. The waste containment area includes but is not limited to settling basins, and areas within berms and diversions that separate uncontaminated storm water. Also included in the definition of production area is any egg washing or egg processing facility, and any area used in the storage, handling, treatment, or disposal of mortalities.

"Proposed permit" means a VPDES permit prepared after the close of the public comment period (and, when applicable, any public hearing and administrative appeals) which is sent to EPA for review before final issuance. A proposed permit is not a draft permit.

"Publicly owned treatment works (POTW)" means a treatment works as defined by § 212 of the CWA, which is owned by a state or municipality (as defined by § 502(4) of the CWA). This definition includes any devices and systems used in the storage, treatment, recycling, and reclamation of municipal sewage or industrial wastes of a liquid nature. It also includes sewers, pipes, and other conveyances only if they convey wastewater to a POTW treatment plant. The term also means the municipality as defined in § 502(4) of the CWA, which has jurisdiction over the indirect discharges to and the discharges from such a treatment works.

"Recommencing discharger" means a source which recommences discharge after terminating operations.

"Regional administrator" means the Regional Administrator of Region III of the Environmental Protection Agency or the authorized representative of the regional administrator.

"Rock crushing and gravel washing facilities" means facilities which process crushed and broken stone, gravel, and riprap.

"Schedule of compliance" means a schedule of remedial measures included in a permit, including an enforceable sequence of interim requirements (for example, actions, operations, or milestone events) leading to compliance with the law, the CWA and regulations.

"Secondary industry category" means any industry category which is not a primary industry category.

"Secretary" means the Secretary of the Army, acting through the Chief of Engineers.

"Septage" means the liquid and solid material pumped from a septic tank, cesspool, or similar domestic sewage treatment

system, or a holding tank when the system is cleaned or maintained.

["Setback area" means the area of land between the boundary of the land application area and adjacent features where biosolids or other managed pollutants may not be land applied.]

"Severe property damage" means substantial physical damage to property, damage to the treatment facilities which causes them to become inoperable, or substantial and permanent loss of natural resources which can reasonably be expected to occur in the absence of a bypass. Severe property damage does not mean economic loss caused by delays in production.

"Sewage from vessels" means human body wastes and the wastes from toilets and other receptacles intended to receive or retain body wastes that are discharged from vessels and regulated under § 312 of CWA.

"Sewage sludge" means any solid, semisolid, or liquid residue removed during the treatment of municipal waste water or domestic sewage. Sewage sludge includes, but is not limited to, solids removed during primary, secondary, or advanced waste water treatment, scum, domestic septage, portable toilet pumpings, type III marine sanitation device pumpings, and sewage sludge products. Sewage sludge does not include grit or screenings, or ash generated during the incineration of sewage sludge.

"Sewage sludge use" or "disposal practice" means the collection, storage, treatment, transportation, processing, monitoring, use of biosolids, or disposal of sewage sludge.

"Significant industrial user" or "SIU" means:

1. Except as provided in subdivisions 2 and 3 of this definition:

a. All industrial users subject to categorical pretreatment standards under 9VAC25-31-780 and incorporated by reference in 9VAC25-31-30; and

b. Any other industrial user that: discharges an average of 25,000 gallons per day or more of process wastewater to the POTW (excluding sanitary, noncontact cooling and boiler blowdown wastewater); contributes a process wastestream which makes up 5.0% or more of the average dry weather hydraulic or organic capacity of the POTW treatment plant; or is designated as such by the Control Authority, on the basis that the industrial user has a reasonable potential for adversely affecting the POTW's operation or for violating any pretreatment standard or requirement.

2. The control authority may determine that an industrial user subject to categorical pretreatment standards under 9VAC25-31-780 and 40 CFR chapter I, subchapter N is a nonsignificant categorical industrial user rather than a significant industrial user on a finding that the industrial user never discharges more than 100 gallons per day (gpd) of total categorical wastewater (excluding sanitary,

Regulations

noncontact cooling and boiler blowdown wastewater, unless specifically included in the pretreatment standard) and the following conditions are met:

- a. The industrial user, prior to control authority's finding, has consistently complied with all applicable categorical pretreatment standards and requirements;
- b. The industrial user annually submits the certification statement required in 9VAC25-31-840 together with any additional information necessary to support the certification statement; and
- c. The industrial user never discharges any untreated concentrated wastewater.

3. Upon a finding that an industrial user meeting the criteria in subdivision 1 b of this definition has no reasonable potential for adversely affecting the POTW's operation or for violating any pretreatment standard or requirement, the control authority may at any time, on its own initiative or in response to a petition received from an industrial user or POTW, and in accordance with Part VII (9VAC25-31-730 et seq.) of this chapter, determine that such industrial user is not a significant industrial user.

"Significant materials" means, but is not limited to: raw materials; fuels; materials such as solvents, detergents, and plastic pellets; finished materials such as metallic products; raw materials used in food processing or production; hazardous substances designated under § 101(14) of CERCLA (42 USC § 9601(14)); any chemical the facility is required to report pursuant to § 313 of Title III of SARA (42 USC § 11023); fertilizers; pesticides; and waste products such as ashes, slag and sludge that have the potential to be released with storm water discharges.

"Silvicultural point source" means any discernible, confined and discrete conveyance related to rock crushing, gravel washing, log sorting, or log storage facilities which are operated in connection with silvicultural activities and from which pollutants are discharged into surface waters. The term does not include nonpoint source silvicultural activities such as nursery operations, site preparation, reforestation and subsequent cultural treatment, thinning, prescribed burning, pest and fire control, harvesting operations, surface drainage, or road construction and maintenance from which there is natural run-off. However, some of these activities (such as stream crossing for roads) may involve point source discharges of dredged or fill material which may require a CWA § 404 permit.

"Site" means the land or water area where any facility or activity is physically located or conducted, including adjacent land used in connection with the facility or activity.

"Sludge-only facility" means any treatment works treating domestic sewage whose methods of biosolids use or sewage sludge use or disposal are subject to regulations promulgated pursuant to the law and § 405(d) of the CWA, and is required to obtain a VPDES permit.

"Source" means any building, structure, facility, or installation from which there is or may be a discharge of pollutants.

"Standards for biosolids use or sewage sludge use or disposal" means the regulations promulgated pursuant to the law and § 405(d) of the CWA which govern minimum requirements for sludge quality, management practices, and monitoring and reporting applicable to sewage sludge or the use of biosolids or disposal of sewage sludge by any person.

"State" means the Commonwealth of Virginia.

"State/EPA agreement" means an agreement between the regional administrator and the state which coordinates EPA and state activities, responsibilities and programs including those under the CWA and the law.

"State Water Control Law" or "Law" means Chapter 3.1 (§ 62.1-44.2 et seq.) of Title 62.1 of the Code of Virginia.

"Storm water" means storm water run-off, snow melt run-off, and surface run-off and drainage.

"Storm water discharge associated with industrial activity" means the discharge from any conveyance which is used for collecting and conveying storm water and which is directly related to manufacturing, processing or raw materials storage areas at an industrial plant. The term does not include discharges from facilities or activities excluded from the VPDES program. For the categories of industries identified in this definition, the term includes, but is not limited to, storm water discharges from industrial plant yards; immediate access roads and rail lines used or traveled by carriers of raw materials, manufactured products, waste material, or by-products used or created by the facility; material handling sites; refuse sites; sites used for the application or disposal of process waste waters; sites used for the storage and maintenance of material handling equipment; sites used for residual treatment, storage, or disposal; shipping and receiving areas; manufacturing buildings; storage areas (including tank farms) for raw materials, and intermediate and final products; and areas where industrial activity has taken place in the past and significant materials remain and are exposed to storm water. For the purposes of this definition, material handling activities include the storage, loading and unloading, transportation, or conveyance of any raw material, intermediate product, final product, by-product, or waste product. The term excludes areas located on plant lands separate from the plant's industrial activities, such as office buildings and accompanying parking lots as long as the drainage from the excluded areas is not mixed with storm water drained from the above described areas. Industrial facilities (including industrial facilities that are federally, state, or municipally owned or operated that meet the description of the facilities listed in subdivisions 1 through 10 of this definition) include those facilities designated under the provisions of 9VAC25-31-120 A 1 c. The following categories of facilities are considered to be engaging in industrial activity for purposes of this subsection:

1. Facilities subject to storm water effluent limitations guidelines, new source performance standards, or toxic pollutant effluent standards (except facilities with toxic pollutant effluent standards which are exempted under category 10);

2. Facilities classified as Standard Industrial Classifications 24 (except 2434), 26 (except 265 and 267), 28 (except 283), 29, 311, 32 (except 323), 33, 3441, 373;

3. Facilities classified as Standard Industrial Classifications 10 through 14 (mineral industry) including active or inactive mining operations (except for areas of coal mining operations no longer meeting the definition of a reclamation area under 40 CFR 434.11(l) because the performance bond issued to the facility by the appropriate SMCRA authority has been released, or except for areas of non-coal mining operations which have been released from applicable state or federal reclamation requirements after December 17, 1990) and oil and gas exploration, production, processing, or treatment operations, or transmission facilities that discharge storm water contaminated by contact with or that has come into contact with, any overburden, raw material, intermediate products, finished products, by-products, or waste products located on the site of such operations; (inactive mining operations are mining sites that are not being actively mined, but which have an identifiable owner/operator; inactive mining sites do not include sites where mining claims are being maintained prior to disturbances associated with the extraction, beneficiation, or processing of mined materials, nor sites where minimal activities are undertaken for the sole purpose of maintaining a mining claim);

4. Hazardous waste treatment, storage, or disposal facilities, including those that are operating under interim status or a permit under Subtitle C of RCRA (42 USC § 6901 et seq.);

5. Landfills, land application sites, and open dumps that receive or have received any industrial wastes (waste that is received from any of the facilities described under this subsection) including those that are subject to regulation under Subtitle D of RCRA (42 USC § 6901 et seq.);

6. Facilities involved in the recycling of materials, including metal scrapyards, battery reclaimers, salvage yards, and automobile junkyards, including but limited to those classified as Standard Industrial Classification 5015 and 5093;

7. Steam electric power generating facilities, including coal handling sites;

8. Transportation facilities classified as Standard Industrial Classifications 40, 41, 42 (except 4221-25), 43, 44, 45, and 5171 which have vehicle maintenance shops, equipment cleaning operations, or airport deicing operations. Only those portions of the facility that are either involved in vehicle maintenance (including vehicle rehabilitation, mechanical repairs, painting, fueling, and lubrication),

equipment cleaning operations, airport deicing operations, or which are otherwise identified under subdivisions 1 through 7 or 9 and 10 of this definition are associated with industrial activity;

9. Treatment works treating domestic sewage or any other sewage sludge or wastewater treatment device or system, used in the storage treatment, recycling, and reclamation of municipal or domestic sewage, including land dedicated to the disposal of sewage sludge that are located within the confines of the facility, with a design flow of 1.0 mgd or more, or required to have an approved pretreatment program. Not included are farm lands, domestic gardens or lands used for sludge management where sludge is beneficially reused and which are not physically located in the confines of the facility, or areas that are in compliance with § 405 of the CWA; and

10. Facilities under Standard Industrial Classifications 20, 21, 22, 23, 2434, 25, 265, 267, 27, 283, 30, 31 (except 311), 323, 34 (except 3441), 35, 36, 37 (except 373), 38, 39, and 4221-25.

"Submission" means: (i) a request by a POTW for approval of a pretreatment program to the regional administrator or the director; (ii) a request by POTW to the regional administrator or the director for authority to revise the discharge limits in categorical pretreatment standards to reflect POTW pollutant removals; or (iii) a request to the EPA by the director for approval of the Virginia pretreatment program.

"Surface waters" means:

1. All waters which are currently used, were used in the past, or may be susceptible to use in interstate or foreign commerce, including all waters which are subject to the ebb and flow of the tide;

2. All interstate waters, including interstate wetlands;

3. All other waters such as intrastate lakes, rivers, streams (including intermittent streams), mudflats, sandflats, wetlands, sloughs, prairie potholes, wet meadows, playa lakes, or natural ponds the use, degradation, or destruction of which would affect or could affect interstate or foreign commerce including any such waters:

a. Which are or could be used by interstate or foreign travelers for recreational or other purposes;

b. From which fish or shellfish are or could be taken and sold in interstate or foreign commerce; or

c. Which are used or could be used for industrial purposes by industries in interstate commerce.

4. All impoundments of waters otherwise defined as surface waters under this definition;

5. Tributaries of waters identified in subdivisions 1 through 4 of this definition;

6. The territorial sea; and

Regulations

7. Wetlands adjacent to waters (other than waters that are themselves wetlands) identified in subdivisions 1 through 6 of this definition.

Waste treatment systems, including treatment ponds or lagoons designed to meet the requirements of the CWA and the law, are not surface waters. Surface waters do not include prior converted cropland. Notwithstanding the determination of an area's status as prior converted cropland by any other agency, for the purposes of the Clean Water Act, the final authority regarding the Clean Water Act jurisdiction remains with the EPA.

"Total dissolved solids" means the total dissolved (filterable) solids as determined by use of the method specified in 40 CFR Part 136.

"Toxic pollutant" means any pollutant listed as toxic under § 307(a)(1) of the CWA or, in the case of sludge use or disposal practices, any pollutant identified in regulations implementing § 405(d) of the CWA.

"Treatment facility" means only those mechanical power driven devices necessary for the transmission and treatment of pollutants (e.g., pump stations, unit treatment processes).

"Treatment works" means any devices and systems used for the storage, treatment, recycling or reclamation of sewage or liquid industrial waste, or other waste or necessary to recycle or reuse water, including intercepting sewers, outfall sewers, sewage collection systems, individual systems, pumping, power and other equipment and their appurtenances; extensions, improvements, remodeling, additions, or alterations thereof; and any works, including land that will be an integral part of the treatment process or is used for ultimate disposal of residues resulting from such treatment; or any other method or system used for preventing, abating, reducing, storing, treating, separating, or disposing of municipal waste or industrial waste, including waste in combined sewer water and sanitary sewer systems.

"Treatment works treating domestic sewage" means a POTW or any other sewage sludge or waste water treatment devices or systems, regardless of ownership (including federal facilities), used in the storage, treatment, recycling, and reclamation of municipal or domestic sewage, including land dedicated for the disposal of sewage sludge. This definition does not include septic tanks or similar devices. For purposes of this definition, domestic sewage includes waste and waste water from humans or household operations that are discharged to or otherwise enter a treatment works.

"TWTDS" means treatment works treating domestic sewage.

"Uncontrolled sanitary landfill" means a landfill or open dump, whether in operation or closed, that does not meet the requirements for run-on or run-off controls established pursuant to subtitle D of the Solid Waste Disposal Act (42 USC § 6901 et seq.).

"Upset," except when used in Part VII of this chapter, means an exceptional incident in which there is unintentional and

temporary noncompliance with technology based permit effluent limitations because of factors beyond the reasonable control of the permittee. An upset does not include noncompliance to the extent caused by operational error, improperly designed treatment facilities, inadequate treatment facilities, lack of preventive maintenance, or careless or improper operation.

"Variance" means any mechanism or provision under § 301 or § 316 of the CWA or under 40 CFR Part 125, or in the applicable effluent limitations guidelines which allows modification to or waiver of the generally applicable effluent limitation requirements or time deadlines of the CWA. This includes provisions which allow the establishment of alternative limitations based on fundamentally different factors or on §§ 301(c), 301(g), 301(h), 301(i), or 316(a) of the CWA.

["Vegetated buffer" means a permanent strip of dense perennial vegetation established parallel to the contours of and perpendicular to the dominant slope of the field for the purposes of slowing water runoff, enhancing water infiltration, and minimizing the risk of any potential nutrients or pollutants from leaving the field and reaching surface waters.]

"Virginia Pollutant Discharge Elimination System (VPDES) permit" means a document issued by the board pursuant to this chapter authorizing, under prescribed conditions, the potential or actual discharge of pollutants from a point source to surface waters and the use of biosolids or disposal of sewage sludge. Under the approved state program, a VPDES permit is equivalent to an NPDES permit.

"VPDES application" or "application" means the standard form or forms, including any additions, revisions or modifications to the forms, approved by the administrator and the board for applying for a VPDES permit.

"Wastewater," when used in Part VII of this chapter, means liquid and water carried industrial wastes and domestic sewage from residential dwellings, commercial buildings, industrial and manufacturing facilities and institutions, whether treated or untreated, which are contributed to the POTW.

"Wastewater works operator" means any individual employed or appointed by any owner, and who is designated by such owner to be the person in responsible charge, such as a supervisor, a shift operator, or a substitute in charge, and whose duties include testing or evaluation to control wastewater works operations. Not included in this definition are superintendents or directors of public works, city engineers, or other municipal or industrial officials whose duties do not include the actual operation or direct supervision of wastewater works.

"Water Management Division Director" means the director of the Region III Water Management Division of the Environmental Protection Agency or this person's delegated representative.

"Wetlands" means those areas that are inundated or saturated by surface or [groundwater ~~ground water~~] at a frequency and duration sufficient to support, and that under normal circumstances do support, a prevalence of vegetation typically adapted for life in saturated soil conditions. Wetlands generally include swamps, marshes, bogs, and similar areas.

"Whole effluent toxicity" means the aggregate toxic effect of an effluent measured directly by a toxicity test.

9VAC25-31-60. Effect of a permit.

A. Compliance with a permit.

1. Except for any toxic effluent standards and prohibitions imposed under § 307 of the CWA and standards for biosolids use or sewage sludge use or disposal under § 405(d) of the CWA, compliance with a permit during its term constitutes compliance, for purposes of enforcement, with the law and with §§ 301, 302, 306, 307, 318, 403, and 405 (a) through (b) of the CWA. However, a permit may be modified, revoked and reissued, or terminated during its term for cause as set forth in this chapter.

2. Compliance with a permit condition which implements a particular standard for biosolids use or sewage sludge use or disposal shall be an affirmative defense in any enforcement action brought for a violation of that standard for biosolids use or sewage sludge use or disposal pursuant to the law and §§ 309 and 405(e) of the CWA.

B. The issuance of a permit does not convey any property rights of any sort, or any exclusive privilege.

C. The issuance of a permit does not authorize any injury to persons or property or invasion of other private rights, or any infringement of state or local law or regulations.

Part II

Permit Applications and Special VPDES Permit Programs

9VAC25-31-100. Application for a permit.

A. Duty to apply. ~~Any person who discharges or proposes to discharge pollutants or who owns or operates a sludge-only facility whose sewage sludge use or disposal practice is regulated by 9VAC25-31-420 through 9VAC25-31-720 and who does not have an effective permit, except persons covered by general permits, excluded from the requirement for a permit by this chapter, or a user of a privately owned treatment works unless the board requires otherwise, The following shall submit a complete application to the department in accordance with this section [. The requirements for concentrated animal feeding operations are described in subdivisions C 1 and 3 of 9VAC25-31-130.]~~

1. Any person who discharges or proposes to discharge pollutants; and
2. Any person who owns or operates a sludge-only facility whose biosolids use or sewage sludge disposal practice is regulated by 9VAC25-31-420 through 9VAC25-31-720 and who does not have an effective permit.

~~[All concentrated animal feeding operations have a duty to seek coverage under a VPDES permit.]~~

B. Exceptions: The following are not required to submit a complete application to the department in accordance with this section unless the board requires otherwise:

1. Persons covered by general permits;
2. Persons excluded from the requirement for a permit by this chapter; or
3. A user of a privately owned treatment works.

~~B. C. Who applies. When a facility or activity is owned by one person but is operated by another person, it is the operator's duty to obtain a permit.~~

1. The owner of the facility or operation.
2. When a facility or activity is owned by one person but is operated by another person, it is the operator's duty to obtain a permit.
3. Notwithstanding the requirements of subdivision 2 of this subsection, biosolids land application by the operator may be authorized by the owner's permit.

~~C. D. Time to apply.~~

1. Any person proposing a new discharge, shall submit an application at least 180 days before the date on which the discharge is to commence, unless permission for a later date has been granted by the board. Facilities proposing a new discharge of storm water associated with industrial activity shall submit an application 180 days before that facility commences industrial activity which may result in a discharge of storm water associated with that industrial activity. Different submittal dates may be required under the terms of applicable general permits. Persons proposing a new discharge are encouraged to submit their applications well in advance of the 90 or 180 day requirements to avoid delay. New discharges composed entirely of storm water, other than those dischargers identified in 9VAC25-31-120 A 1, shall apply for and obtain a permit according to the application requirements in 9VAC25-31-120 B.

2. All TWTDS whose ~~sewage sludge~~ biosolids use or sewage sludge disposal practices are regulated by 9VAC25-31-420 through 9VAC25-31-720 must submit permit applications according to the applicable schedule in subdivision 2 a or b of this subsection.

a. A TWTDS with a currently effective VPDES permit must submit a permit application at the time of its next VPDES permit renewal application. Such information must be submitted in accordance with subsection D of this section.

b. Any other TWTDS not addressed under subdivision 2 a of this subsection must submit the information listed in subdivisions 2 b (1) through (5) of this subsection to the department within one year after publication of a standard applicable to its ~~sewage sludge~~ biosolids use or

Regulations

~~sewage sludge disposal practice(s)~~ practice or practices, using a form provided by the department. The board will determine when such TWTDS must submit a full permit application.

(1) The TWTDS's name, mailing address, location, and status as federal, state, private, public or other entity;

(2) The applicant's name, address, telephone number, and ownership status;

(3) A description of the ~~sewage sludge biosolids~~ sewage sludge disposal practices. Unless the ~~sewage sludge biosolids~~ sewage sludge meets the requirements of subdivision ~~P 8-d Q 9 d~~ of this section, the description must include the name and address of any facility where biosolids or sewage sludge is sent for treatment or disposal and the location of any land application sites;

(4) Annual amount of sewage sludge generated, treated, used or disposed (estimated dry weight basis); and

(5) The most recent data the TWTDS may have on the quality of the biosolids or sewage sludge.

c. Notwithstanding subdivision 2 a or b of this subsection, the board may require permit applications from any TWTDS at any time if the board determines that a permit is necessary to protect public health and the environment from any potential adverse effects that may occur from toxic pollutants in sewage sludge.

d. Any TWTDS that commences operations after promulgation of an applicable standard for ~~sewage sludge biosolids~~ sewage sludge use or sewage sludge disposal shall submit an application to the department at least 180 days prior to the date proposed for commencing operations.

~~D.~~ E. Duty to reapply. All permittees with a currently effective permit shall submit a new application at least 180 days before the expiration date of the existing permit, unless permission for a later date has been granted by the board. The board shall not grant permission for applications to be submitted later than the expiration date of the existing permit.

~~E.~~ F. Completeness.

1. The board shall not issue a permit before receiving a complete application for a permit except for VPDES general permits. An application for a permit is complete when the board receives an application form and any supplemental information which are completed to its satisfaction. The completeness of any application for a permit shall be judged independently of the status of any other permit application or permit for the same facility or activity.

2. No application for a VPDES permit to discharge sewage into or adjacent to state waters from a privately owned treatment works serving, or designed to serve, 50 or more residences shall be considered complete unless the applicant has provided the department with notification from the State Corporation Commission that the applicant is incorporated in the Commonwealth and is in compliance

with all regulations and relevant orders of the State Corporation Commission.

3. No application for a new individual VPDES permit authorizing a new discharge of sewage, industrial wastes, or other wastes shall be considered complete unless it contains notification from the county, city, or town in which the discharge is to take place that the location and operation of the discharging facility are consistent with applicable ordinances adopted pursuant to Chapter 22 (§ 15.2-2200 et seq.) of Title 15.2 of the Code of Virginia. The county, city or town shall inform in writing the applicant and the board of the discharging facility's compliance or noncompliance not more than 30 days from receipt by the chief administrative officer, or his agent, of a request from the applicant. Should the county, city or town fail to provide such written notification within 30 days, the requirement for such notification is waived. The provisions of this subsection shall not apply to any discharge for which a valid VPDES permit had been issued prior to March 10, 2000.

4. A permit application shall not be considered complete if the board has waived application requirements under subsection J or P of this section and the EPA has disapproved the waiver application. If a waiver request has been submitted to the EPA more than 210 days prior to permit expiration and the EPA has not disapproved the waiver application 181 days prior to permit expiration, the permit application lacking the information subject to the waiver application shall be considered complete.

5. In accordance with § 62.1-44.19:3 A of the Code of Virginia, no application for a permit or variance to authorize the storage of ~~sewage sludge biosolids~~ sewage sludge shall be complete unless it contains certification from the governing body of the locality in which the ~~sewage sludge biosolids~~ sewage sludge is to be stored that the storage site is consistent with all applicable ordinances. The governing body shall confirm or deny consistency within 30 days of receiving a request for certification. If the governing body does not respond, the site shall be deemed consistent.

6. No application for a permit to land apply biosolids in accordance with Part VI (9VAC25-31-420 et seq.) of this chapter shall be complete unless it includes the written consent of the landowner to apply biosolids on his property.

~~F.~~ G. Information requirements. All applicants for VPDES permits, other than POTWs and other TWTDS, shall provide the following information to the department, using the application form provided by the department (additional information required of applicants is set forth in subsections ~~G~~ H through ~~K~~ L of this section).

1. The activities conducted by the applicant which require it to obtain a VPDES permit;

2. Name, mailing address, and location of the facility for which the application is submitted;

3. Up to four SIC codes which best reflect the principal products or services provided by the facility;
4. The operator's name, address, telephone number, ownership status, and status as federal, state, private, public, or other entity;
5. Whether the facility is located on Indian lands;
6. A listing of all permits or construction approvals received or applied for under any of the following programs:
 - a. Hazardous Waste Management program under RCRA (42 USC § 6921);
 - b. UIC program under SDWA (42 USC § 300h);
 - c. VPDES program under the CWA and the law;
 - d. Prevention of Significant Deterioration (PSD) program under the Clean Air Act (42 USC § 4701 et seq.);
 - e. Nonattainment program under the Clean Air Act (42 USC § 4701 et seq.);
 - f. National Emission Standards for Hazardous Pollutants (NESHAPS) preconstruction approval under the Clean Air Act (42 USC § 4701 et seq.);
 - g. Ocean dumping permits under the Marine Protection Research and Sanctuaries Act (33 USC § 14 et seq.);
 - h. Dredge or fill permits under § 404 of the CWA; and
 - i. Other relevant environmental permits, including state permits.
7. A topographic map (or other map if a topographic map is unavailable) extending one mile beyond the property boundaries of the source, depicting the facility and each of its intake and discharge structures; each of its hazardous waste treatment, storage, or disposal facilities; each well where fluids from the facility are injected underground; and those wells, springs, other surface water bodies, and drinking water wells listed in public records or otherwise known to the applicant in the map area; and
8. A brief description of the nature of the business.

~~G. H.~~ Application requirements for existing manufacturing, commercial, mining, and silvicultural dischargers. Existing manufacturing, commercial mining, and silvicultural dischargers applying for VPDES permits, except for those facilities subject to the requirements of ~~9VAC25-31-100-H~~ subsection I of this section, shall provide the following information to the department, using application forms provided by the department.

1. The latitude and longitude of each outfall to the nearest 15 seconds and the name of the receiving water.
2. A line drawing of the water flow through the facility with a water balance, showing operations contributing wastewater to the effluent and treatment units. Similar processes, operations, or production areas may be indicated as a single unit, labeled to correspond to the more detailed identification under subdivision 3 of this subsection. The

water balance must show approximate average flows at intake and discharge points and between units, including treatment units. If a water balance cannot be determined (for example, for certain mining activities), the applicant may provide instead a pictorial description of the nature and amount of any sources of water and any collection and treatment measures.

3. A narrative identification of each type of process, operation, or production area which contributes wastewater to the effluent for each outfall, including process wastewater, cooling water, and storm water run-off; the average flow which each process contributes; and a description of the treatment the wastewater receives, including the ultimate disposal of any solid or fluid wastes other than by discharge. Processes, operations, or production areas may be described in general terms (for example, dye-making reactor, distillation tower). For a privately owned treatment works, this information shall include the identity of each user of the treatment works. The average flow of point sources composed of storm water may be estimated. The basis for the rainfall event and the method of estimation must be indicated.

4. If any of the discharges described in subdivision 3 of this subsection are intermittent or seasonal, a description of the frequency, duration and flow rate of each discharge occurrence (except for storm water run-off, spillage or leaks).

5. If an effluent guideline promulgated under § 304 of the CWA applies to the applicant and is expressed in terms of production (or other measure of operation), a reasonable measure of the applicant's actual production reported in the units used in the applicable effluent guideline. The reported measure must reflect the actual production of the facility.

6. If the applicant is subject to any present requirements or compliance schedules for construction, upgrading or operation of waste treatment equipment, an identification of the abatement requirement, a description of the abatement project, and a listing of the required and projected final compliance dates.

7. ~~a.~~ Information on the discharge of pollutants specified in this subdivision (except information on storm water discharges which is to be provided as specified in 9VAC25-31-120).

a. When quantitative data for a pollutant are required, the applicant must collect a sample of effluent and analyze it for the pollutant in accordance with analytical methods approved under 40 CFR Part 136. When no analytical method is approved, the applicant may use any suitable method but must provide a description of the method. When an applicant has two or more outfalls with substantially identical effluents, the board may allow the applicant to test only one outfall and report that the quantitative data also apply to the substantially identical

Regulations

outfalls. The requirements in ~~e and f of this subdivision 7 e and f of this subsection~~ that an applicant must provide quantitative data for certain pollutants known or believed to be present do not apply to pollutants present in a discharge solely as the result of their presence in intake water; however, an applicant must report such pollutants as present. Grab samples must be used for pH, temperature, cyanide, total phenols, residual chlorine, oil and grease, fecal coliform, and fecal streptococcus. For all other pollutants, 24-hour composite samples must be used. However, a minimum of one grab sample may be taken for effluents from holding ponds or other impoundments with a retention period greater than 24 hours. In addition, for discharges other than storm water discharges, the board may waive composite sampling for any outfall for which the applicant demonstrates that the use of an automatic sampler is infeasible and that the minimum of four grab samples will be a representative sample of the effluent being discharged.

b. For storm water discharges, all samples shall be collected from the discharge resulting from a storm event that is greater than 0.1 inch and at least 72 hours from the previously measurable (greater than 0.1 inch rainfall) storm event. Where feasible, the variance in the duration of the event and the total rainfall of the event should not exceed 50% from the average or median rainfall event in that area. For all applicants, a flow-weighted composite shall be taken for either the entire discharge or for the first three hours of the discharge. The flow-weighted composite sample for a storm water discharge may be taken with a continuous sampler or as a combination of a minimum of three sample aliquots taken in each hour of discharge for the entire discharge or for the first three hours of the discharge, with each aliquot being separated by a minimum period of 15 minutes (applicants submitting permit applications for storm water discharges under 9VAC25-31-120 C may collect flow-weighted composite samples using different protocols with respect to the time duration between the collection of sample aliquots, subject to the approval of the board). However, a minimum of one grab sample may be taken for storm water discharges from holding ponds or other impoundments with a retention period greater than 24 hours. For a flow-weighted composite sample, only one analysis of the composite of aliquots is required. For storm water discharge samples taken from discharges associated with industrial activities, quantitative data must be reported for the grab sample taken during the first 30 minutes (or as soon thereafter as practicable) of the discharge for all pollutants specified in 9VAC25-31-120 B 1. For all storm water permit applicants taking flow-weighted composites, quantitative data must be reported for all pollutants specified in 9VAC25-31-120 except pH, temperature, cyanide, total phenols, residual chlorine, oil and grease, fecal coliform, and fecal

streptococcus. The board may allow or establish appropriate site-specific sampling procedures or requirements, including sampling locations, the season in which the sampling takes place, the minimum duration between the previous measurable storm event and the storm event sampled, the minimum or maximum level of precipitation required for an appropriate storm event, the form of precipitation sampled (snow melt or rain fall), protocols for collecting samples under 40 CFR Part 136, and additional time for submitting data on a case-by-case basis. An applicant is expected to know or have reason to believe that a pollutant is present in an effluent based on an evaluation of the expected use, production, or storage of the pollutant, or on any previous analyses for the pollutant. (For example, any pesticide manufactured by a facility may be expected to be present in contaminated storm water run-off from the facility.)

c. Every applicant must report quantitative data for every outfall for the following pollutants:

- (1) Biochemical oxygen demand (BOD₅) [;]
- (2) Chemical oxygen demand [;]
- (3) Total organic carbon [;]
- (4) Total suspended solids [;]
- (5) Ammonia (as N) [;]
- (6) Temperature (both winter and summer) [; and]
- (7) pH [;]

d. The board may waive the reporting requirements for individual point sources or for a particular industry category for one or more of the pollutants listed in subdivision 7 c of this subsection if the applicant has demonstrated that such a waiver is appropriate because information adequate to support issuance of a permit can be obtained with less stringent requirements.

e. Each applicant with processes in one or more primary industry category (see 40 CFR Part 122 Appendix A) contributing to a discharge must report quantitative data for the following pollutants in each outfall containing process wastewater, except as indicated in subdivisions 7 c (3), (4), and (5) of this subsection:

- (1) The organic toxic pollutants in the fractions designated in Table I of 40 CFR Part 122 Appendix D for the applicant's industrial category or categories unless the applicant qualifies as a small business under subdivision 8 of this subsection. Table II of 40 CFR Part 122 Appendix D lists the organic toxic pollutants in each fraction. The fractions result from the sample preparation required by the analytical procedure which uses gas chromatography/mass spectrometry. A determination that an applicant falls within a particular industrial category for the purposes of selecting fractions for testing is not conclusive as to the applicant's inclusion in that category for any other purposes; ~~and~~.

(2) The pollutants listed in Table III of 40 CFR Part 122 Appendix D (the toxic metals, cyanide, and total phenols).

(3) Subdivision H 7 e (1) of this section and the corresponding portions of the VPDES application Form 2C are suspended as they apply to coal mines.

(4) Subdivision H 7 e (1) of this section and the corresponding portions of Item V-C of the VPDES application Form 2C are suspended as they apply to:

(a) Testing and reporting for all four organic fractions in the Greige Mills Subcategory of the Textile Mills industry (subpart C-Low water use processing of 40 CFR Part 410), and testing and reporting for the pesticide fraction in all other subcategories of this industrial category.

(b) Testing and reporting for the volatile, base/neutral and pesticide fractions in the Base and Precious Metals Subcategory of the Ore Mining and Dressing industry (subpart B of 40 CFR Part 440), and testing and reporting for all four fractions in all other subcategories of this industrial category.

(c) Testing and reporting for all four GC/MS fractions in the Porcelain Enameling industry.

(5) Subdivision H 7 e (1) of this section and the corresponding portions of Item V-C of the VPDES application Form 2C are suspended as they apply to:

(a) Testing and reporting for the pesticide fraction in the Tall Oil Rosin Subcategory (subpart D) and Rosin-Based Derivatives Subcategory (subpart F) of the Gum and Wood Chemicals industry (40 CFR Part 454), and testing and reporting for the pesticide and base-neutral fractions in all other subcategories of this industrial category.

(b) Testing and reporting for the pesticide fraction in the leather tanning and finishing, paint and ink formulation, and photographic supplies industrial categories.

(c) Testing and reporting for the acid, base/neutral, and pesticide fractions in the petroleum refining industrial category.

(d) Testing and reporting for the pesticide fraction in the Papergrade Sulfite Subcategories (subparts J and U) of the Pulp and Paper industry (40 CFR Part 430); testing and reporting for the base/neutral and pesticide fractions in the following subcategories: Deink (subpart Q), Dissolving Kraft (subpart F), and Paperboard from Waste Paper (subpart E); testing and reporting for the volatile, base/neutral, and pesticide fractions in the following subcategories: BCT Bleached Kraft (subpart H), Semi-Chemical (subparts B and C), and Nonintegrated-Fine Papers (subpart R); and testing and reporting for the acid, base/neutral, and pesticide fractions in the following subcategories: Fine Bleached Kraft (subpart I), Dissolving Sulfite Pulp (subpart K), Groundwood-Fine Papers (subpart O), Market Bleached Kraft (subpart G),

Tissue from Wastepaper (subpart T), and Nonintegrated-Tissue Papers (subpart S).

(e) Testing and reporting for the base/neutral fraction in the Once-Through Cooling Water, Fly Ash and Bottom Ash Transport Water process waste streams of the Steam Electric Power Plant industrial category.

f. ~~(4)~~ Each applicant must indicate whether it knows or has reason to believe that any of the pollutants in Table IV of 40 CFR Part 122 Appendix D (certain conventional and nonconventional pollutants) is discharged from each outfall. If an applicable effluent limitations guideline either directly limits the pollutant or, by its express terms, indirectly limits the pollutant through limitations on an indicator, the applicant must report quantitative data. For every pollutant discharged which is not so limited in an effluent limitations guideline, the applicant must either report quantitative data or briefly describe the reasons the pollutant is expected to be discharged.

~~(2)~~ g. Each applicant must indicate whether it knows or has reason to believe that any of the pollutants listed in Table II or Table III of 40 CFR Part 122 Appendix D (the toxic pollutants and total phenols) for which quantitative data are not otherwise required under subdivision 7 e of this subsection, is discharged from each outfall. For every pollutant expected to be discharged in concentrations of 10 ppb or greater the applicant must report quantitative data. For acrolein, acrylonitrile, 2,4 dinitrophenol, and 2-methyl-4,6 dinitrophenol, where any of these four pollutants are expected to be discharged in concentrations of 100 ppb or greater the applicant must report quantitative data. For every pollutant expected to be discharged in concentrations less than 10 ppb, or in the case of acrolein, acrylonitrile, 2,4 dinitrophenol, and 2-methyl-4,6 dinitrophenol, in concentrations less than 100 ppb, the applicant must either submit quantitative data or briefly describe the reasons the pollutant is expected to be discharged. An applicant qualifying as a small business under subdivision 8 of this subsection is not required to analyze for pollutants listed in Table II of 40 CFR Part 122 Appendix D (the organic toxic pollutants).

~~g.~~ h. Each applicant must indicate whether it knows or has reason to believe that any of the pollutants in Table V of 40 CFR Part 122 Appendix D (certain hazardous substances and asbestos) are discharged from each outfall. For every pollutant expected to be discharged, the applicant must briefly describe the reasons the pollutant is expected to be discharged, and report any quantitative data it has for any pollutant.

~~h.~~ i. Each applicant must report qualitative data, generated using a screening procedure not calibrated with analytical standards, for 2,3,7,8-tetrachlorodibenzo-p-dioxin (TCDD) if it:

Regulations

(1) Uses or manufactures 2,4,5-trichlorophenoxy acetic acid (2,4,5,-T); 2-(2,4,5-trichlorophenoxy) propanoic acid (Silvex, 2,4,5,-TP); 2-(2,4,5-trichlorophenoxy) ethyl, 2,2-dichloropropionate (Erbon); O,O-dimethyl O-(2,4,5-trichlorophenyl) phosphorothioate (Ronnel); 2,4,5-trichlorophenol (TCP); or hexachlorophene (HCP); or

(2) Knows or has reason to believe that TCDD is or may be present in an effluent.

8. An applicant which qualifies as a small business under one of the following criteria is exempt from the requirements in subdivision 7 e (1) or 7 f (4) of this subsection to submit quantitative data for the pollutants listed in Table II of 40 CFR Part 122 Appendix D (the organic toxic pollutants):

a. For coal mines, a probable total annual production of less than 100,000 tons per year; or

b. For all other applicants, gross total annual sales averaging less than \$100,000 per year (in second quarter 1980 dollars).

9. A listing of any toxic pollutant which the applicant currently uses or manufactures as an intermediate or final product or byproduct. The board may waive or modify this requirement for any applicant if the applicant demonstrates that it would be unduly burdensome to identify each toxic pollutant and the board has adequate information to issue the permit.

10. Reserved.

11. An identification of any biological toxicity tests which the applicant knows or has reason to believe have been made within the last three years on any of the applicant's discharges or on a receiving water in relation to a discharge.

12. If a contract laboratory or consulting firm performed any of the analyses required by subdivision 7 of this subsection, the identity of each laboratory or firm and the analyses performed.

13. In addition to the information reported on the application form, applicants shall provide to the board, at its request, such other information, including pertinent plans, specifications, maps and such other relevant information as may be required, in scope and details satisfactory to the board, as the board may reasonably require to assess the discharges of the facility and to determine whether to issue a VPDES permit. The additional information may include additional quantitative data and bioassays to assess the relative toxicity of discharges to aquatic life and requirements to determine the cause of the toxicity.

H. I. Application requirements for manufacturing, commercial, mining and silvicultural facilities which discharge only nonprocess wastewater. Except for storm water discharges, all manufacturing, commercial, mining and silvicultural dischargers applying for VPDES permits which

discharge only nonprocess wastewater not regulated by an effluent limitations guideline or new source performance standard shall provide the following information to the department using application forms provided by the department:

1. Outfall number, latitude and longitude to the nearest 15 seconds, and the name of the receiving water;

2. Date of expected commencement of discharge;

3. An identification of the general type of waste discharged, or expected to be discharged upon commencement of operations, including sanitary wastes, restaurant or cafeteria wastes, or noncontact cooling water. An identification of cooling water additives (if any) that are used or expected to be used upon commencement of operations, along with their composition if existing composition is available;

4. a. Quantitative data for the pollutants or parameters listed below, unless testing is waived by the board. The quantitative data may be data collected over the past 365 days, if they remain representative of current operations, and must include maximum daily value, average daily value, and number of measurements taken. The applicant must collect and analyze samples in accordance with 40 CFR Part 136. Grab samples must be used for pH, temperature, oil and grease, total residual chlorine, and fecal coliform. For all other pollutants, 24-hour composite samples must be used. New dischargers must include estimates for the pollutants or parameters listed below instead of actual sampling data, along with the source of each estimate. All levels must be reported or estimated as concentration and as total mass, except for flow, pH, and temperature.

(1) Biochemical oxygen demand (BOD₅).

(2) Total suspended solids (TSS).

(3) Fecal coliform (if believed present or if sanitary waste is or will be discharged).

(4) Total residual chlorine (if chlorine is used).

(5) Oil and grease.

(6) Chemical oxygen demand (COD) (if noncontact cooling water is or will be discharged).

(7) Total organic carbon (TOC) (if noncontact cooling water is or will be discharged).

(8) Ammonia (as N).

(9) Discharge flow.

(10) pH.

(11) Temperature (winter and summer).

b. The board may waive the testing and reporting requirements for any of the pollutants or flow listed in subdivision 4 a of this subsection if the applicant submits a request for such a waiver before or with his application which demonstrates that information adequate to support

issuance of a permit can be obtained through less stringent requirements.

c. If the applicant is a new discharger, he must submit the information required in subdivision 4 a of this subsection by providing quantitative data in accordance with that section no later than two years after commencement of discharge. However, the applicant need not submit testing results which he has already performed and reported under the discharge monitoring requirements of his VPDES permit.

d. The requirements of subdivisions 4 a and 4 c of this subsection that an applicant must provide quantitative data or estimates of certain pollutants do not apply to pollutants present in a discharge solely as a result of their presence in intake water. However, an applicant must report such pollutants as present. Net credit may be provided for the presence of pollutants in intake water if the requirements of 9VAC25-31-230 G are met;

5. A description of the frequency of flow and duration of any seasonal or intermittent discharge (except for storm water run-off, leaks, or spills);

6. A brief description of any treatment system used or to be used;

7. Any additional information the applicant wishes to be considered, such as influent data for the purpose of obtaining net credits pursuant to 9VAC25-31-230 G;

8. Signature of certifying official under 9VAC25-31-110; and

9. Pertinent plans, specifications, maps and such other relevant information as may be required, in scope and details satisfactory to the board.

J. Application requirements for new and existing concentrated animal feeding operations and aquatic animal production facilities. New and existing concentrated animal feeding operations and concentrated aquatic animal production facilities shall provide the following information to the department, using the application form provided by the department:

1. For concentrated animal feeding operations:

a. The name of the owner or operator;

b. The facility location and mailing address;

c. Latitude and longitude of the production area (entrance to the production area);

d. A topographic map of the geographic area in which the CAFO is located showing the specific location of the production area, in lieu of the requirements of subdivision F 7 of this section;

e. Specific information about the number and type of animals, whether in open confinement or housed under roof (beef cattle, broilers, layers, swine weighing 55 pounds or more, swine weighing less than 55 pounds,

mature dairy cows, dairy heifers, veal calves, sheep and lambs, horses, ducks, turkeys, other);

f. The type of containment and storage (anaerobic lagoon, roofed storage shed, storage ponds, underfloor pits, above ground storage tanks, below ground storage tanks, concrete pad, impervious soil pad, other) and total capacity for manure, litter, and process wastewater storage (tons/gallons);

g. The total number of acres under control of the applicant available for land application of manure, litter, or process wastewater;

h. Estimated amounts of manure, litter, and process wastewater generated per year (tons/gallons); and

i. For CAFOs required to seek coverage under a permit after December 31, 2009, a nutrient management plan that at a minimum satisfies the requirements specified in subsection E of 9VAC25-31-200 and subdivision C 9 of 9VAC25-31-130, including, for all CAFOs subject to 40 CFR Part 412 Subpart C or Subpart D, the requirements of 40 CFR 412.4(c), as applicable.

2. For concentrated aquatic animal production facilities:

a. The maximum daily and average monthly flow from each outfall;

b. The number of ponds, raceways, and similar structures;

c. The name of the receiving water and the source of intake water;

d. For each species of aquatic animals, the total yearly and maximum harvestable weight;

e. The calendar month of maximum feeding and the total mass of food fed during that month; and

f. Pertinent plans, specifications, maps and such other relevant information as may be required, in scope and details satisfactory to the board.

K. Application requirements for new and existing POTWs and treatment works treating domestic sewage. Unless otherwise indicated, all POTWs and other dischargers designated by the board must provide to the department, at a minimum, the information in this subsection using an application form provided by the department. Permit applicants must submit all information available at the time of permit application. The information may be provided by referencing information previously submitted to the department. The board may waive any requirement of this subsection if it has access to substantially identical information. The board may also waive any requirement of this subsection that is not of material concern for a specific permit, if approved by the regional administrator. The waiver request to the regional administrator must include the board's justification for the waiver. A regional administrator's disapproval of the board's proposed waiver does not constitute final agency action but does provide notice to the

Regulations

board and permit applicant(s) that the EPA may object to any board-issued permit issued in the absence of the required information.

1. All applicants must provide the following information:
 - a. Name, mailing address, and location of the facility for which the application is submitted;
 - b. Name, mailing address, and telephone number of the applicant and indication as to whether the applicant is the facility's owner, operator, or both;
 - c. Identification of all environmental permits or construction approvals received or applied for (including dates) under any of the following programs:
 - (1) Hazardous Waste Management program under the Resource Conservation and Recovery Act (RCRA), Subpart C;
 - (2) Underground Injection Control program under the Safe Drinking Water Act (SDWA);
 - (3) NPDES program under the Clean Water Act (CWA);
 - (4) Prevention of Significant Deterioration (PSD) program under the Clean Air Act;
 - (5) Nonattainment program under the Clean Air Act;
 - (6) National Emission Standards for Hazardous Air Pollutants (NESHAPS) preconstruction approval under the Clean Air Act;
 - (7) Ocean dumping permits under the Marine Protection Research and Sanctuaries Act;
 - (8) Dredge or fill permits under § 404 of the CWA; and
 - (9) Other relevant environmental permits, including state permits;
 - d. The name and population of each municipal entity served by the facility, including unincorporated connector districts. Indicate whether each municipal entity owns or maintains the collection system and whether the collection system is separate sanitary or combined storm and sanitary, if known;
 - e. Information concerning whether the facility is located in Indian country and whether the facility discharges to a receiving stream that flows through Indian country;
 - f. The facility's design flow rate (the wastewater flow rate the plant was built to handle), annual average daily flow rate, and maximum daily flow rate for each of the previous three years;
 - g. Identification of type(s) of collection system(s) used by the treatment works (i.e., separate sanitary sewers or combined storm and sanitary sewers) and an estimate of the percent of sewer line that each type comprises; and
 - h. The following information for outfalls to surface waters and other discharge or disposal methods:
 - (1) For effluent discharges to surface waters, the total number and types of outfalls (e.g., treated effluent,

combined sewer overflows, bypasses, constructed emergency overflows);

- (2) For wastewater discharged to surface impoundments:
 - (a) The location of each surface impoundment;
 - (b) The average daily volume discharged to each surface impoundment; and
 - (c) Whether the discharge is continuous or intermittent;
 - (3) For wastewater applied to the land:
 - (a) The location of each land application site;
 - (b) The size of each land application site, in acres;
 - (c) The average daily volume applied to each land application site, in gallons per day; and
 - (d) Whether land application is continuous or intermittent;
 - (4) For effluent sent to another facility for treatment prior to discharge:
 - (a) The means by which the effluent is transported;
 - (b) The name, mailing address, contact person, and phone number of the organization transporting the discharge, if the transport is provided by a party other than the applicant;
 - (c) The name, mailing address, contact person, phone number, and VPDES permit number (if any) of the receiving facility; and
 - (d) The average daily flow rate from this facility into the receiving facility, in millions of gallons per day; and
 - (5) For wastewater disposed of in a manner not included in subdivisions 1 h (1) through (4) of this subsection (e.g., underground percolation, underground injection):
 - (a) A description of the disposal method, including the location and size of each disposal site, if applicable;
 - (b) The annual average daily volume disposed of by this method, in gallons per day; and
 - (c) Whether disposal through this method is continuous or intermittent;
2. All applicants with a design flow greater than or equal to 0.1 mgd must provide the following information:
 - a. The current average daily volume of inflow and infiltration, in gallons per day, and steps the facility is taking to minimize inflow and infiltration;
 - b. A topographic map (or other map if a topographic map is unavailable) extending at least one mile beyond property boundaries of the treatment plant, including all unit processes, and showing:
 - (1) Treatment plant area and unit processes;
 - (2) The major pipes or other structures through which wastewater enters the treatment plant and the pipes or other structures through which treated wastewater is discharged from the treatment plant. Include outfalls from bypass piping, if applicable;

- (3) Each well where fluids from the treatment plant are injected underground;
 - (4) Wells, springs, and other surface water bodies listed in public records or otherwise known to the applicant within 1/4 mile of the treatment works' property boundaries;
 - (5) Sewage sludge management facilities (including on-site treatment, storage, and disposal sites); and
 - (6) Location at which waste classified as hazardous under RCRA enters the treatment plant by truck, rail, or dedicated pipe;
- c. Process flow diagram or schematic.
- (1) A diagram showing the processes of the treatment plant, including all bypass piping and all backup power sources or redundancy in the system. This includes a water balance showing all treatment units, including disinfection, and showing daily average flow rates at influent and discharge points, and approximate daily flow rates between treatment units; and
 - (2) A narrative description of the diagram; and
- d. The following information regarding scheduled improvements:
- (1) The outfall number of each outfall affected;
 - (2) A narrative description of each required improvement;
 - (3) Scheduled or actual dates of completion for the following:
 - (a) Commencement of construction;
 - (b) Completion of construction;
 - (c) Commencement of discharge; and
 - (d) Attainment of operational level; and
 - (4) A description of permits and clearances concerning other federal or state requirements;
3. Each applicant must provide the following information for each outfall, including bypass points, through which effluent is discharged, as applicable:
- a. The following information about each outfall:
 - (1) Outfall number;
 - (2) State, county, and city or town in which outfall is located;
 - (3) Latitude and longitude, to the nearest second;
 - (4) Distance from shore and depth below surface;
 - (5) Average daily flow rate, in million gallons per day;
 - (6) The following information for each outfall with a seasonal or periodic discharge:
 - (a) Number of times per year the discharge occurs;
 - (b) Duration of each discharge;
 - (c) Flow of each discharge; and
 - (d) Months in which discharge occurs; and
 - (7) Whether the outfall is equipped with a diffuser and the type (e.g., high-rate) of diffuser used.
 - b. The following information, if known, for each outfall through which effluent is discharged to surface waters:
 - (1) Name of receiving water;
 - (2) Name of watershed/river/stream system and United States Soil Conservation Service 14-digit watershed code;
 - (3) Name of State Management/River Basin and United States Geological Survey 8-digit hydrologic cataloging unit code; and
 - (4) Critical flow of receiving stream and total hardness of receiving stream at critical low flow (if applicable).
 - c. The following information describing the treatment provided for discharges from each outfall to surface waters:
 - (1) The highest level of treatment (e.g., primary, equivalent to secondary, secondary, advanced, other) that is provided for the discharge for each outfall and:
 - (a) Design biochemical oxygen demand (BOD₅ or CBOD₅) removal (percent);
 - (b) Design suspended solids (SS) removal (percent); and, where applicable;
 - (c) Design phosphorus (P) removal (percent);
 - (d) Design nitrogen (N) removal (percent); and
 - (e) Any other removals that an advanced treatment system is designed to achieve.
 - (2) A description of the type of disinfection used, and whether the treatment plant dechlorinates (if disinfection is accomplished through chlorination).
4. Effluent monitoring for specific parameters.
- a. As provided in subdivisions 4 b through j 4 k of this subsection, all applicants must submit to the department effluent monitoring information for samples taken from each outfall through which effluent is discharged to surface waters, except for CSOs. The board may allow applicants to submit sampling data for only one outfall on a case-by-case basis, where the applicant has two or more outfalls with substantially identical effluent. The board may also allow applicants to composite samples from one or more outfalls that discharge into the same mixing zone.
 - b. All applicants must sample and analyze for the following pollutants:
 - (1) Biochemical oxygen demand (BOD₅ or CBOD₅);
 - (2) Fecal coliform;
 - (3) Design flow rate;
 - (4) pH;
 - (5) Temperature; and

Regulations

(6) Total suspended solids.

c. All applicants with a design flow greater than or equal to 0.1 mgd must sample and analyze for the following pollutants:

- (1) Ammonia (as N);
- (2) Chlorine (total residual, TRC);
- (3) Dissolved oxygen;
- (4) Nitrate/Nitrite;
- (5) Kjeldahl nitrogen;
- (6) Oil and grease;
- (7) Phosphorus; and
- (8) Total dissolved solids.

d. Facilities that do not use chlorine for disinfection, do not use chlorine elsewhere in the treatment process, and have no reasonable potential to discharge chlorine in their effluent may delete chlorine.

e. All POTWs with a design flow rate equal to or greater than one million gallons per day, all POTWs with approved pretreatment programs or POTWs required to develop a pretreatment program, and other POTWs, as required by the board must sample and analyze for the pollutants listed in Table 2 of 40 CFR Part 122 Appendix J, and for any other pollutants for which the board or EPA have established water quality standards applicable to the receiving waters.

f. The board may require sampling for additional pollutants, as appropriate, on a case-by-case basis.

g. Applicants must provide data from a minimum of three samples taken within 4-1/2 years prior to the date of the permit application. Samples must be representative of the seasonal variation in the discharge from each outfall. Existing data may be used, if available, in lieu of sampling done solely for the purpose of this application. The board may require additional samples, as appropriate, on a case-by-case basis.

h. All existing data for pollutants specified in subdivisions 4 b through 4 f of this subsection that is collected within 4-1/2 years of the application must be included in the pollutant data summary submitted by the applicant. If, however, the applicant samples for a specific pollutant on a monthly or more frequent basis, it is only necessary, for such pollutant, to summarize all data collected within one year of the application.

i. Applicants must collect samples of effluent and analyze such samples for pollutants in accordance with analytical methods approved under 40 CFR Part 136 unless an alternative is specified in the existing VPDES permit. Grab samples must be used for pH, temperature, cyanide, total phenols, residual chlorine, oil and grease, and fecal coliform. For all other pollutants, 24-hour composite samples must be used. For a composite

sample, only one analysis of the composite of aliquots is required.

j. The effluent monitoring data provided must include at least the following information for each parameter:

- (1) Maximum daily discharge, expressed as concentration or mass, based upon actual sample values;
- (2) Average daily discharge for all samples, expressed as concentration or mass, and the number of samples used to obtain this value;
- (3) The analytical method used; and
- (4) The threshold level (i.e., method detection limit, minimum level, or other designated method endpoints) for the analytical method used.

k. Unless otherwise required by the board, metals must be reported as total recoverable.

5. Effluent monitoring for whole effluent toxicity.

a. All applicants must provide an identification of any whole effluent toxicity tests conducted during the 4-1/2 years prior to the date of the application on any of the applicant's discharges or on any receiving water near the discharge.

b. As provided in subdivisions 5 c through i of this subsection, the following applicants must submit to the department the results of valid whole effluent toxicity tests for acute or chronic toxicity for samples taken from each outfall through which effluent is discharged to surface waters, except for combined sewer overflows:

- (1) All POTWs with design flow rates greater than or equal to one million gallons per day;
- (2) All POTWs with approved pretreatment programs or POTWs required to develop a pretreatment program;
- (3) Other POTWs, as required by the board, based on consideration of the following factors:
 - (a) The variability of the pollutants or pollutant parameters in the POTW effluent (based on chemical-specific information, the type of treatment plant, and types of industrial contributors);
 - (b) The ratio of effluent flow to receiving stream flow;
 - (c) Existing controls on point or nonpoint sources, including total maximum daily load calculations for the receiving stream segment and the relative contribution of the POTW;
 - (d) Receiving stream characteristics, including possible or known water quality impairment, and whether the POTW discharges to a coastal water, or a water designated as an outstanding natural resource water; or
 - (e) Other considerations (including, but not limited to, the history of toxic impacts and compliance problems at the POTW) that the board determines could cause or contribute to adverse water quality impacts.

c. Where the POTW has two or more outfalls with substantially identical effluent discharging to the same receiving stream segment, the board may allow applicants to submit whole effluent toxicity data for only one outfall on a case-by-case basis. The board may also allow applicants to composite samples from one or more outfalls that discharge into the same mixing zone.

d. Each applicant required to perform whole effluent toxicity testing pursuant to subdivision 5 b of this subsection must provide:

- (1) Results of a minimum of four quarterly tests for a year, from the year preceding the permit application; or
- (2) Results from four tests performed at least annually in the 4-1/2 year period prior to the application, provided the results show no appreciable toxicity using a safety factor determined by the board.

e. Applicants must conduct tests with multiple species (no less than two species, e.g., fish, invertebrate, plant) and test for acute or chronic toxicity, depending on the range of receiving water dilution. The board recommends that applicants conduct acute or chronic testing based on the following dilutions: (i) acute toxicity testing if the dilution of the effluent is greater than 100:1 at the edge of the mixing zone or (ii) chronic toxicity testing if the dilution of the effluent is less than or equal to 100:1 at the edge of the mixing zone.

f. Each applicant required to perform whole effluent toxicity testing pursuant to subdivision 5 b of this subsection must provide the number of chronic or acute whole effluent toxicity tests that have been conducted since the last permit reissuance.

g. Applicants must provide the results using the form provided by the department, or test summaries if available and comprehensive, for each whole effluent toxicity test conducted pursuant to subdivision 5 b of this subsection for which such information has not been reported previously to the department.

h. Whole effluent toxicity testing conducted pursuant to subdivision 5 b of this subsection must be conducted using methods approved under 40 CFR Part 136, as directed by the board.

i. For whole effluent toxicity data submitted to the department within 4-1/2 years prior to the date of the application, applicants must provide the dates on which the data were submitted and a summary of the results.

j. Each POTW required to perform whole effluent toxicity testing pursuant to subdivision 5 b of this subsection must provide any information on the cause of toxicity and written details of any toxicity reduction evaluation conducted, if any whole effluent toxicity test conducted within the past 4-1/2 years revealed toxicity.

6. Applicants must submit the following information about industrial discharges to the POTW:

a. Number of significant industrial users (SIUs) and categorical industrial users (CIUs) discharging to the POTW; and

b. POTWs with one or more SIUs shall provide the following information for each SIU, as defined in 9VAC25-31-10, that discharges to the POTW:

- (1) Name and mailing address;
- (2) Description of all industrial processes that affect or contribute to the SIU's discharge;
- (3) Principal products and raw materials of the SIU that affect or contribute to the SIU's discharge;
- (4) Average daily volume of wastewater discharged, indicating the amount attributable to process flow and nonprocess flow;
- (5) Whether the SIU is subject to local limits;
- (6) Whether the SIU is subject to categorical standards and, if so, under which category and subcategory; and
- (7) Whether any problems at the POTW (e.g., upsets, pass through, interference) have been attributed to the SIU in the past 4-1/2 years.

c. The information required in subdivisions 6 a and b of this subsection may be waived by the board for POTWs with pretreatment programs if the applicant has submitted either of the following that contain information substantially identical to that required in subdivisions 6 a and b of this subsection:

- (1) An annual report submitted within one year of the application; or
- (2) A pretreatment program.

7. Discharges from hazardous waste generators and from waste cleanup or remediation sites. POTWs receiving Resource Conservation and Recovery Act (RCRA), Comprehensive Environmental Response, Compensation, and Liability Act (CERCLA), or RCRA Corrective Action wastes or wastes generated at another type of cleanup or remediation site must provide the following information:

a. If the POTW receives, or has been notified that it will receive, by truck, rail, or dedicated pipe any wastes that are regulated as RCRA hazardous wastes pursuant to 40 CFR Part 261, the applicant must report the following:

- (1) The method by which the waste is received (i.e., whether by truck, rail, or dedicated pipe); and
- (2) The hazardous waste number and amount received annually of each hazardous waste.

b. If the POTW receives, or has been notified that it will receive, wastewaters that originate from remedial activities, including those undertaken pursuant to CERCLA and § 3004(u) or 3008(h) of RCRA, the applicant must report the following:

- (1) The identity and description of the site or facility at which the wastewater originates;

Regulations

(2) The identities of the wastewater's hazardous constituents, as listed in Appendix VIII of 40 CFR Part 261, if known; and

(3) The extent of treatment, if any, the wastewater receives or will receive before entering the POTW.

c. Applicants are exempt from the requirements of subdivision 7 b of this subsection if they receive no more than 15 kilograms per month of hazardous wastes, unless the wastes are acute hazardous wastes as specified in 40 CFR 261.30(d) and 261.33(e).

8. Each applicant with combined sewer systems must provide the following information:

a. The following information regarding the combined sewer system:

(1) A map indicating the location of the following:

(a) All CSO discharge points;

(b) Sensitive use areas potentially affected by CSOs (e.g., beaches, drinking water supplies, shellfish beds, sensitive aquatic ecosystems, and outstanding national resource waters); and

(c) Waters supporting threatened and endangered species potentially affected by CSOs; and

(2) A diagram of the combined sewer collection system that includes the following information:

(a) The location of major sewer trunk lines, both combined and separate sanitary;

(b) The locations of points where separate sanitary sewers feed into the combined sewer system;

(c) In-line and off-line storage structures;

(d) The locations of flow-regulating devices; and

(e) The locations of pump stations.

b. The following information for each CSO discharge point covered by the permit application:

(1) The following information on each outfall:

(a) Outfall number;

(b) State, county, and city or town in which outfall is located;

(c) Latitude and longitude, to the nearest second;

(d) Distance from shore and depth below surface;

(e) Whether the applicant monitored any of the following in the past year for this CSO: (i) rainfall, (ii) CSO flow volume, (iii) CSO pollutant concentrations, (iv) receiving water quality, or (v) CSO frequency; and

(f) The number of storm events monitored in the past year;

(2) The following information about CSO overflows from each outfall:

(a) The number of events in the past year;

(b) The average duration per event, if available;

(c) The average volume per CSO event, if available; and
(d) The minimum rainfall that caused a CSO event, if available, in the last year;

(3) The following information about receiving waters:

(a) Name of receiving water;

(b) Name of watershed/stream system and the United States Soil Conservation Service watershed (14-digit) code, if known; and

(c) Name of State Management/River Basin and the United States Geological Survey hydrologic cataloging unit (8-digit) code, if known; and

(4) A description of any known water quality impacts on the receiving water caused by the CSO (e.g., permanent or intermittent beach closings, permanent or intermittent shellfish bed closings, fish kills, fish advisories, other recreational loss, or exceedance of any applicable state water quality standard).

9. All applicants must provide the name, mailing address, telephone number, and responsibilities of all contractors responsible for any operational or maintenance aspects of the facility.

10. All applications must be signed by a certifying official in compliance with 9VAC25-31-110.

11. Pertinent plans, specifications, maps and such other relevant information as may be required, in scope and details satisfactory to the board.

~~K~~. L. Application requirements for new sources and new discharges. New manufacturing, commercial, mining and silvicultural dischargers applying for VPDES permits (except for new discharges of facilities subject to the requirements of subsection H of this section or new discharges of storm water associated with industrial activity which are subject to the requirements of 9VAC25-31-120 B 1 and this subsection) shall provide the following information to the department, using the application forms provided by the department:

1. The expected outfall location in latitude and longitude to the nearest 15 seconds and the name of the receiving water;

2. The expected date of commencement of discharge;

3. a. Description of the treatment that the wastewater will receive, along with all operations contributing wastewater to the effluent, average flow contributed by each operation, and the ultimate disposal of any solid or liquid wastes not discharged;

b. A line drawing of the water flow through the facility with a water balance as described in subdivision G 2;

c. If any of the expected discharges will be intermittent or seasonal, a description of the frequency, duration and maximum daily flow rate of each discharge occurrence (except for storm water run-off, spillage, or leaks); and

4. If a new source performance standard promulgated under § 306 of the CWA or an effluent limitation guideline

applies to the applicant and is expressed in terms of production (or other measure of operation), a reasonable measure of the applicant's expected actual production reported in the units used in the applicable effluent guideline or new source performance standard for each of the first three years. Alternative estimates may also be submitted if production is likely to vary;

5. The requirements in subdivisions H 4 a, b, and c of this section that an applicant must provide estimates of certain pollutants expected to be present do not apply to pollutants present in a discharge solely as a result of their presence in intake water; however, an applicant must report such pollutants as present. Net credits may be provided for the presence of pollutants in intake water if the requirements of 9VAC25-31-230 G are met. All levels (except for discharge flow, temperature, and pH) must be estimated as concentration and as total mass.

a. Each applicant must report estimated daily maximum, daily average, and source of information for each outfall for the following pollutants or parameters. The board may waive the reporting requirements for any of these pollutants and parameters if the applicant submits a request for such a waiver before or with his application which demonstrates that information adequate to support issuance of the permit can be obtained through less stringent reporting requirements.

- (1) Biochemical oxygen demand (BOD).
- (2) Chemical oxygen demand (COD).
- (3) Total organic carbon (TOC).
- (4) Total suspended solids (TSS).
- (5) Flow.
- (6) Ammonia (as N).
- (7) Temperature (winter and summer).
- (8) pH.

b. Each applicant must report estimated daily maximum, daily average, and source of information for each outfall for the following pollutants, if the applicant knows or has reason to believe they will be present or if they are limited by an effluent limitation guideline or new source performance standard either directly or indirectly through limitations on an indicator pollutant: all pollutants in Table IV of 40 CFR Part 122 Appendix D (certain conventional and nonconventional pollutants).

c. Each applicant must report estimated daily maximum, daily average and source of information for the following pollutants if he knows or has reason to believe that they will be present in the discharges from any outfall:

- (1) The pollutants listed in Table III of 40 CFR Part 122 Appendix D (the toxic metals, in the discharge from any outfall, Total cyanide, and total phenols);
- (2) The organic toxic pollutants in Table II of 40 CFR Part 122 Appendix D (except bis (chloromethyl) ether,

dichlorofluoromethane and trichlorofluoromethane). This requirement is waived for applicants with expected gross sales of less than \$100,000 per year for the next three years, and for coal mines with expected average production of less than 100,000 tons of coal per year.

d. The applicant is required to report that 2,3,7,8 Tetrachlorodibenzo-P-Dioxin (TCDD) may be discharged if he uses or manufactures one of the following compounds, or if he knows or has reason to believe that TCDD will or may be present in an effluent:

- (1) 2,4,5-trichlorophenoxy acetic acid (2,4,5-T) (CAS #93-76-5);
- (2) 2-(2,4,5-trichlorophenoxy) propanoic acid (Silvex, 2,4,5-TP) (CAS #93-72-1);
- (3) 2-(2,4,5-trichlorophenoxy) ethyl 2,2-dichloropropionate (Erbon) (CAS #136-25-4);
- (4) 0,0-dimethyl 0-(2,4,5-trichlorophenyl) phosphorothioate (Ronnel) (CAS #299-84-3);
- (5) 2,4,5-trichlorophenol (TCP) (CAS #95-95-4); or
- (6) Hexachlorophene (HCP) (CAS #70-30-4);

e. Each applicant must report any pollutants listed in Table V of 40 CFR Part 122 Appendix D (certain hazardous substances) if he believes they will be present in any outfall (no quantitative estimates are required unless they are already available).

f. No later than two years after the commencement of discharge from the proposed facility, the applicant is required to submit the information required in subsection G of this section. However, the applicant need not complete those portions of subsection G of this section requiring tests which he has already performed and reported under the discharge monitoring requirements of his VPDES permit;

6. Each applicant must report the existence of any technical evaluation concerning his wastewater treatment, along with the name and location of similar plants of which he has knowledge;

7. Any optional information the permittee wishes to have considered;

8. Signature of certifying official under 9VAC25-31-110; and

9. Pertinent plans, specifications, maps and such other relevant information as may be required, in scope and details satisfactory to the board.

M. Variance requests by non-POTWs. A discharger which is not a publicly owned treatment works (POTW) may request a variance from otherwise applicable effluent limitations under any of the following statutory or regulatory provisions within the times specified in this subsection:

1. Fundamentally different factors.

Regulations

a. A request for a variance based on the presence of fundamentally different factors from those on which the effluent limitations guideline was based shall be filed as follows:

(1) For a request from best practicable control technology currently available (BPT), by the close of the public comment period for the draft permit; or

(2) For a request from best available technology economically achievable (BAT) and/or best conventional pollutant control technology (BCT), by no later than:

(a) July 3, 1989, for a request based on an effluent limitation guideline promulgated before February 4, 1987, to the extent July 3, 1989, is not later than that provided under previously promulgated regulations; or

(b) 180 days after the date on which an effluent limitation guideline is published in the Federal Register for a request based on an effluent limitation guideline promulgated on or after February 4, 1987.

b. The request shall explain how the requirements of the applicable regulatory or statutory criteria have been met.

2. A request for a variance from the BAT requirements for CWA § 301(b)(2)(F) pollutants (commonly called nonconventional pollutants) pursuant to § 301(c) of the CWA because of the economic capability of the owner or operator, or pursuant to § 301(g) of the CWA (provided however that a § 301(g) variance may only be requested for ammonia; chlorine; color; iron; total phenols (when determined by the Administrator to be a pollutant covered by § 301(b)(2)(F) of the CWA) and any other pollutant which the administrator lists under § 301(g)(4) of the CWA) must be made as follows:

a. For those requests for a variance from an effluent limitation based upon an effluent limitation guideline by:

(1) Submitting an initial request to the regional administrator, as well as to the department, stating the name of the discharger, the permit number, the outfall number(s), the applicable effluent guideline, and whether the discharger is requesting a §§ 301(c) or 301(g) of the CWA modification, or both. This request must have been filed not later than 270 days after promulgation of an applicable effluent limitation guideline; and

(2) Submitting a completed request no later than the close of the public comment period for the draft permit demonstrating that: (i) all reasonable ascertainable issues have been raised and all reasonably available arguments and materials supporting their position have been submitted; and (ii) that the applicable requirements of 40 CFR Part 125 have been met. Notwithstanding this provision, the complete application for a request under § 301(g) of the CWA shall be filed 180 days before EPA must make a decision (unless the Regional Division Director establishes a shorter or longer period); or

b. For those requests for a variance from effluent limitations not based on effluent limitation guidelines, the request need only comply with subdivision 2 a (2) of this subsection and need not be preceded by an initial request under subdivision 2 a (1) of this subsection.

3. A modification under § 302(b)(2) of the CWA of requirements under § 302(a) of the CWA for achieving water quality related effluent limitations may be requested no later than the close of the public comment period for the draft permit on the permit from which the modification is sought.

4. A variance for alternate effluent limitations for the thermal component of any discharge must be filed with a timely application for a permit under this section, except that if thermal effluent limitations are established on a case-by-case basis or are based on water quality standards the request for a variance may be filed by the close of the public comment period for the draft permit. A copy of the request shall be sent simultaneously to the department.

~~M. N.~~ Variance requests by POTWs. A discharger which is a publicly owned treatment works (POTW) may request a variance from otherwise applicable effluent limitations under any of the following statutory provisions as specified in this paragraph:

1. A request for a modification under § 301(h) of the CWA of requirements of § 301(b)(1)(B) of the CWA for discharges into marine waters must be filed in accordance with the requirements of 40 CFR Part 125, Subpart G.

2. A modification under § 302(b)(2) of the CWA of the requirements under § 302(a) of the CWA for achieving water quality based effluent limitations shall be requested no later than the close of the public comment period for the draft permit on the permit from which the modification is sought.

~~N. O.~~ Expedited variance procedures and time extensions.

1. Notwithstanding the time requirements in subsections ~~L M~~ and ~~M N~~ of this section, the board may notify a permit applicant before a draft permit is issued that the draft permit will likely contain limitations which are eligible for variances. In the notice the board may require the applicant as a condition of consideration of any potential variance request to submit a request explaining how the requirements of 40 CFR Part 125 applicable to the variance have been met and may require its submission within a specified reasonable time after receipt of the notice. The notice may be sent before the permit application has been submitted. The draft or final permit may contain the alternative limitations which may become effective upon final grant of the variance.

2. A discharger who cannot file a timely complete request required under subdivisions ~~L 2 a (2) or L 2 b~~ M 2 a (2) or M 2 b of this section may request an extension. The extension may be granted or denied at the discretion of the

board. Extensions shall be no more than six months in duration.

~~Θ.~~ P. Recordkeeping. Except for information required by subdivision ~~Θ-2~~ D 2 of this section, which shall be retained for a period of at least five years from the date the application is signed (or longer as required by Part VI (9VAC25-31-420 et seq.) of this chapter), applicants shall keep records of all data used to complete permit applications and any supplemental information submitted under this section for a period of at least three years from the date the application is signed.

~~P.~~ Q. Sewage sludge management. All TWTDS subject to subdivision ~~Θ-2-a~~ D 2 a of this section must provide the information in this subsection to the department using an application form approved by the department. New applicants must submit all information available at the time of permit application. The information may be provided by referencing information previously submitted to the department. The board may waive any requirement of this subsection if it has access to substantially identical information. The board may also waive any requirement of this subsection that is not of material concern for a specific permit, if approved by the regional administrator. The waiver request to the regional administrator must include the board's justification for the waiver. A regional administrator's disapproval of the board's proposed waiver does not constitute final agency action, but does provide notice to the board and the permit applicant that the EPA may object to any board issued permit issued in the absence of the required information.

1. All applicants must submit the following information:
 - a. The name, mailing address, and location of the TWTDS for which the application is submitted;
 - b. Whether the facility is a Class I Sludge Management Facility;
 - c. The design flow rate (in million gallons per day);
 - d. The total population served;
 - e. The TWTDS's status as federal, state, private, public, or other entity;
 - f. The name, mailing address, and telephone number of the applicant; and
 - g. Indication whether the applicant is the owner, operator, or both.
2. All applicants must submit the facility's VPDES permit number, if applicable, and a listing of all other federal, state, and local permits or construction approvals received or applied for under any of the following programs:
 - a. Hazardous Waste Management program under the Resource Conservation and Recovery Act (RCRA);
 - b. UIC program under the Safe Drinking Water Act (SDWA);
 - c. NPDES program under the Clean Water Act (CWA);

- d. Prevention of Significant Deterioration (PSD) program under the Clean Air Act;
- e. Nonattainment program under the Clean Air Act;
- f. National Emission Standards for Hazardous Air Pollutants (NESHAPS) preconstruction approval under the Clean Air Act;
- g. Dredge or fill permits under § 404 of the CWA;
- h. Other relevant environmental permits, including state or local permits.

3. All applicants must identify any generation, treatment, storage, land application of biosolids, or disposal of sewage sludge that occurs in Indian country.

4. All applicants must submit a topographic map (or other map if a topographic map is unavailable) extending one mile beyond property boundaries of the facility and showing the following information:

- a. All sewage sludge management facilities, including on-site treatment, storage, and disposal sites; and
- b. Wells, springs, and other surface water bodies that are within 1/4 mile of the property boundaries and listed in public records or otherwise known to the applicant.

5. All applicants must submit a line drawing and/or a narrative description that identifies all sewage sludge management practices employed during the term of the permit, including all units used for collecting, dewatering, storing, or treating sewage sludge; the destination(s) of all liquids and solids leaving each such unit; and all processes used for pathogen reduction and vector attraction reduction.

6. All applicants must submit an odor control plan that contains at minimum:

- a. Methods used to minimize odor in producing biosolids;
- b. Methods used to identify malodorous biosolids before land application (at the generating facility);
- c. Methods used to identify and abate malodorous biosolids that have been delivered to the field, prior to land application; and
- d. Methods used to abate malodor from biosolids if land applied.

~~6-7.~~ 7. The applicant must submit ~~sewage sludge biosolids~~ monitoring data for the pollutants for which limits in ~~sewage sludge biosolids~~ have been established in Part VI (9VAC25-31-420 et seq.) of this chapter for the applicant's use or disposal practices on the date of permit application with the following conditions:

- a. When applying for authorization to land apply a biosolids source not previously included in a VPDES or Virginia Pollution Abatement Permit, the biosolids shall be sampled and analyzed for PCBs. The sample results

Regulations

shall be submitted with the permit application or request to add the source.

~~a.~~ b. The board may require sampling for additional pollutants, as appropriate, on a case-by-case basis.

~~b.~~ c. Applicants must provide data from a minimum of three samples taken within 4-1/2 years prior to the date of the permit application. Samples must be representative of the ~~sewage sludge~~ biosolids and should be taken at least one month apart. Existing data may be used in lieu of sampling done solely for the purpose of this application.

~~e.~~ d. Applicants must collect and analyze samples in accordance with analytical methods specified in 9VAC25-31-490 [~~unless an alternative has been specified in an existing~~] ~~sewage sludge~~ [biosolids use permit. Samples for PCB analysis shall be collected and analyzed in accordance with EPA Method 1668 B., 40 CFR Part 503 (March 26, 2007) and 40 CFR Part 136 (March 26, 2007).]

~~d.~~ e. The monitoring data provided must include at least the following information for each parameter:

- (1) Average monthly concentration for all samples (mg/kg dry weight), based upon actual sample values;
- (2) The analytical method used; and
- (3) The method detection level.

~~7.~~ 8. If the applicant is a person who prepares biosolids or sewage sludge, as defined in 9VAC25-31-500, the applicant must provide the following information:

a. If the applicant's facility generates biosolids or sewage sludge, the total dry metric tons per 365-day period generated at the facility.

b. If the applicant's facility receives biosolids or sewage sludge from another facility, the following information for each facility from which biosolids or sewage sludge is received:

- (1) The name, mailing address, and location of the other facility;
- (2) The total dry metric tons per 365-day period received from the other facility; and
- (3) A description of any treatment processes occurring at the other facility, including blending activities and treatment to reduce pathogens or vector attraction characteristics.

c. If the applicant's facility changes the quality of biosolids or sewage sludge through blending, treatment, or other activities, the following information:

- (1) Whether the Class A pathogen reduction requirements in 9VAC25-31-710 A or the Class B pathogen reduction requirements in 9VAC25-31-710 B are met, and a description of any treatment processes used to reduce pathogens in sewage sludge;

(2) Whether any of the vector attraction reduction options of 9VAC25-31-720 B 1 through 8 are met, and a description of any treatment processes used to reduce vector attraction properties in sewage sludge; and

(3) A description of any other blending, treatment, or other activities that change the quality of sewage sludge.

d. If ~~sewage sludge~~ biosolids from the applicant's facility meets the ceiling concentrations in 9VAC25-31-540 B [Table] 1, the pollutant concentrations in 9VAC25-31-540 B [Table] 3, the Class A pathogen requirements in 9VAC25-31-710 A, and one of the vector attraction reduction requirements in 9VAC25-31-720 B 1 through 8, and if the ~~sewage sludge~~ biosolids is applied to the land, the applicant must provide the total dry metric tons per 365-day period of sewage sludge subject to this subsection that is applied to the land.

e. If ~~sewage sludge~~ biosolids from the applicant's facility is sold or given away in a bag or other container for application to the land, and the ~~sewage sludge~~ biosolids is not subject to subdivision ~~7~~ 8 d of this subsection, the applicant must provide the following information:

(1) The total dry metric tons per 365-day period of ~~sewage sludge~~ biosolids subject to this subsection that is sold or given away in a bag or other container for application to the land; and

(2) A copy of all labels or notices that accompany the ~~sewage sludge~~ biosolids being sold or given away.

f. If biosolids or sewage sludge from the applicant's facility is provided to another person who prepares ~~sewage sludge, biosolids,~~ as defined in 9VAC25-31-500, and the ~~sewage sludge~~ biosolids is not subject to subdivision ~~7~~ 8 d of this subsection, the applicant must provide the following information for each facility receiving the biosolids or sewage sludge:

(1) The name and mailing address of the receiving facility;

(2) The total dry metric tons per 365-day period of biosolids or sewage sludge subject to this subsection that the applicant provides to the receiving facility;

(3) A description of any treatment processes occurring at the receiving facility, including blending activities and treatment to reduce pathogens or vector attraction characteristic;

(4) A copy of the notice and necessary information that the applicant is required to provide the receiving facility under 9VAC25-31-530 G; and

(5) If the receiving facility places ~~sewage sludge~~ biosolids in bags or containers for sale or give-away ~~to~~ for application to the land, a copy of any labels or notices that accompany the ~~sewage sludge~~ biosolids.

~~8.~~ 9. If ~~sewage sludge~~ biosolids from the applicant's facility is applied to the land in bulk form and is not subject to

subdivision 7 8 d, e, or f of this subsection, the applicant must provide the following information:

a. [Written permission of landowners on the most current form approved by the board.

b.] The total dry metric tons per 365-day period of ~~sewage sludge biosolids~~ subject to this subsection that is applied to the land.

~~[b. c.]~~ If any land application sites are located in states other than the state where the ~~sewage sludge biosolids~~ is prepared, a description of how the applicant will notify the permitting authority for the state(s) where the land application sites are located.

~~[e. d.]~~ The following information for each land application site that has been identified at the time of permit application:

(1) The ~~name (if any),~~ DEQ control number, if previously assigned, identifying the land application field or site [. If a DEQ control number has not been assigned, provide the site identification code used by the permit applicant to report activities] and the site's location for the land application site;

(2) The site's latitude and longitude ~~[to the nearest second, in decimal degrees to three decimal places]~~ and method of determination;

(3) ~~A topographic map (or other map if a topographic map is unavailable) that shows the site's location; A legible topographic map [and aerial photograph, including legend,] of proposed application areas to scale as needed to depict the following features:~~

~~(a) Property boundaries;~~

~~(b) Surface water courses;~~

~~(c) Water supply wells and springs;~~

~~(d) Roadways;~~

~~(e) Rock outcrops;~~

~~(f) Slopes;~~

~~(g) Frequently flooded areas (National Resources Conservation Service (NRCS) designation); [and~~

~~(h) Occupied dwellings within 400 feet of the property boundaries and all existing extended dwelling and property line setback distances;~~

~~(i) Publicly accessible properties and occupied buildings within 400 feet of the property boundaries and the associated extended setback distances; and~~

~~(j)] The gross acreage of the fields where biosolids will be applied;~~

(4) County map or other map of sufficient detail to show general location of the site and proposed transport vehicle haul routes to be utilized from the treatment plant;

(5) County tax maps [labeled with Tax Parcel ID or IDs] for each farm to be included in the permit, which

may include multiple fields [, to depict properties within 400 feet of the field boundaries];

(6) A USDA soil survey map, if available, of proposed sites for land application of biosolids;

~~(4) (7) The name, mailing address, and telephone number of [the each] site owner, if different from the applicant;~~

~~(5) (8) The name, mailing address, and telephone number of the person who applies ~~sewage sludge biosolids~~ to the site, if different from the applicant;~~

~~(6) (9) Whether the site is agricultural land, forest, a public contact site, or a reclamation site, as such site types are defined in 9VAC25-31-500;~~

~~(7) (10) The type of vegetation grown on the site, if known, and the nitrogen requirement for this vegetation~~
Description of agricultural practices including a list of proposed crops to be grown;

~~(8) (11) Whether either of the vector attraction reduction options of 9VAC25-31-720 B 9 or 10 is met at the site, and a description of any procedures employed at the time of use to reduce vector attraction properties in ~~sewage sludge biosolids; and~~~~

(12) Pertinent calculations justifying storage and land area requirements for biosolids application including an annual biosolids balance incorporating such factors as precipitation, evapotranspiration, soil percolation rates, wastewater loading, and monthly storage (input and drawdown); and

~~(9) (13) Other information that describes how the site will be managed, as specified by the board.~~

~~[d. For permit applications proposing frequent application of biosolids, the following additional site information will be necessary:~~

~~(1) Information specified (subdivisions 2 a and 4 of this subsection);~~

~~(2) Representative soil borings and test pits to a depth of five feet or to bedrock if shallower are to be coordinated for each major soil type and the following tests performed and data collected:~~

~~(a) Soil type;~~

~~(b) Soil texture for each horizon (USDA classification);~~

~~(c) Soil color for each horizon;~~

~~(d) Depth from surface to mottling and bedrock if less than two feet;~~

~~(e) Depth from surface to subsoil restrictive layer;~~

~~(f) Indicated infiltration rate (surface soil); and~~

~~(g) Indicated permeability of subsoil restrictive layer.~~

~~(3) Additional soil testing in accordance with Table 6 (9VAC25-32-460); and~~

Regulations

~~(4) Ground water monitoring plans for the land treatment area including pertinent geohydrologic data to justify upgradient and downgradient well location and depth.]~~

~~d. e.~~ The following information for each land application site that has been identified at the time of permit application, if the applicant intends to apply bulk ~~sewage sludge~~ biosolids subject to the cumulative pollutant loading rates in 9VAC25-31-540 B [Table] 2 to the site:

(1) Whether the applicant has contacted the permitting authority in the state where the bulk ~~sewage sludge~~ biosolids subject to 9VAC25-31-540 B [Table] 2 will be applied, to ascertain whether bulk ~~sewage sludge~~ biosolids subject to 9VAC25-31-540 B [Table] 2 has been applied to the site on or since July 20, 1993, and if so, the name of the permitting authority and the name and phone number of a contact person at the permitting authority; [and]

(2) Identification of facilities other than the applicant's facility that have sent, or are sending, ~~sewage sludge~~ biosolids subject to the cumulative pollutant loading rates in 9VAC25-31-540 B [Table] 2 to the site since July 20, 1993, if, based on the inquiry in subdivision ~~8-d~~ 9-e (1) of this subsection, bulk ~~sewage sludge~~ biosolids subject to cumulative pollutant loading rates in 9VAC25-31-540 B [Table] 2 has been applied to the site since July 20, 1993.

~~e. [f. If not all land application sites have been identified at the time of permit application, the applicant must submit a land application plan that, at a minimum:~~

- ~~(1) Describes the geographical area covered by the plan;~~
- ~~(2) Identifies the site selection criteria;~~
- ~~(3) Describes how the site(s) will be managed;~~

~~(4) Provides for advance notice to the board department of specific land application sites] and reasonable time for the board to object prior to land application of the sewage sludge and to notify persons residing on property bordering such sites for the purpose of receiving written comments from those persons for a period not to exceed 30 days. The department shall, based upon these comments, determine whether additional site specific requirements should be included in the authorization for land application at the site [in a manner prescribed by 9VAC25-31-485 D; and~~

~~(5) Provides for advance notice of land application sites in a manner prescribed by 9VAC25-31-290.]~~

~~(5) Provides for advance public notice of land application sites in a newspaper of general circulation in the area of the land application site.~~

~~A request to increase the acreage authorized by the initial permit by 50% or more shall be treated as a new application for purposes of public notice and public hearings.~~

10. Biosolids storage facilities not located at the site of the wastewater treatment plant. Plans and specifications for biosolids storage facilities not located at the site of the wastewater treatment plant generating the biosolids, including routine and on-site storage, shall be submitted for issuance of a certificate to construct and a certificate to operate in accordance with the Sewage Collection and Treatment Regulations (9VAC25-790) and shall depict the following information:

a. Site layout on a recent 7.5 minute topographic quadrangle or other appropriate scaled map;

b. Location of any required soil, geologic, and hydrologic test holes or borings;

c. Location of the following field features within 0.25 miles of the site boundary (indicate on map) with the approximate distances from the site boundary:

(1) Water wells (operating or abandoned);

(2) Surface waters;

(3) Springs;

(4) Public water supplies;

(5) Sinkholes;

(6) Underground and surface mines;

(7) Mine pool (or other) surface water discharge points;

(8) Mining spoil piles and mine dumps;

(9) Quarries;

(10) Sand and gravel pits;

(11) Gas and oil wells;

(12) Diversion ditches;

(13) Occupied dwellings, including industrial and commercial establishments;

(14) Landfills and dumps;

(15) Other unlined impoundments;

(16) Septic tanks and drainfields; and

(17) Injection wells;

d. Topographic map (10-foot contour preferred) of sufficient detail to clearly show the following information:

(1) Maximum and minimum percent slopes;

(2) Depressions on the site that may collect water;

(3) Drainage ways that may attribute to rainfall run-on to or run-off from this site; and

(4) Portions of the site, if any, that are located within the 100-year floodplain;

e. Data and specifications for the liner proposed for seepage control;

f. Scaled plan view and cross-sectional view of the facilities showing inside and outside slopes of all embankments and details of all appurtenances;

g. Calculations justifying impoundment capacity; and
 h. ~~[Ground water~~ Groundwater] monitoring plans for the facilities ~~[including if required by the department. The groundwater monitoring plan shall include]~~ pertinent geohydrological data to justify upgradient and downgradient well location and depth.

11. Staging. Generic plans are required for staging of biosolids.

12. A biosolids ~~[operations]~~ management plan shall be provided that includes the following minimum site specific information at the time of permit application:

a. A comprehensive, general description of the operation shall be provided, including biosolids source or sources, quantities, flow diagram illustrating treatment works biosolids flows and solids handling units, site description, methodology of biosolids handling for application periods, including storage and nonapplication period storage, and alternative management methods when storage is not provided.

b. A nutrient management plan approved by the Department of Conservation and Recreation ~~[shall be as]~~ required for application sites prior to board authorization under the following conditions:

(1) Sites operated by an owner or lessee of a confined animal feeding operation, as defined in subsection A of § 62.1-44.17:1 of the Code of Virginia, or confined poultry feeding operation, as defined in subsection A of § 62.1-44.17:1.1 of the Code of Virginia;

(2) Sites where land application is proposed more frequently than once every three years at greater than 50% of the annual agronomic rate; ~~[and]~~

(3) Mined ~~[or disturbed]~~ land sites where land application is proposed at greater than agronomic rates ~~[; or]~~

(4) Other sites based on site-specific conditions that increase the risk that land application may adversely impact state waters.]

13. Biosolids transport.

a. ~~[Description and specifications on the bed or the tank vehicle]~~ General description of transport vehicles to be used];

b. ~~[Haul routes to be used from the biosolids generator to the storage unit and land application sites;]~~

~~e.]~~ Procedures for biosolids offloading at the biosolids facilities and the land application site together with spill prevention, cleanup (including vehicle cleaning), field reclamation, and emergency spill notification and cleanup measures; and

~~[d. c.]~~ Voucher system used for documentation and recordkeeping.

14. Field operations.

a. Storage.

(1) Routine storage ~~[at facilities not located at the site of the wastewater treatment plant]~~ – supernatant handling and disposal, biosolids handling, and loading of transport vehicles, equipment cleaning, freeboard maintenance, and inspections for structural integrity;

(2) On-site storage – procedures for department/board approval and implementation;

(3) Staging – procedures to be followed including either designated site locations provided in the "Design Information" or the specific site criteria for such locations including the liner/cover requirements and the time limit assigned to such use; and

(4) Field ~~[reclamation~~ reestablishment] of offloading (staging) areas.

b. Application methodology.

(1) Description and specifications on spreader vehicles;

(2) Procedures for calibrating equipment for various biosolids contents to ensure uniform distribution and appropriate loading rates on a day-to-day basis; and

(3) Procedures used to ensure that operations address the following constraints: application of biosolids to frozen ground, pasture/hay fields, crops for direct human consumption and ~~[saturate saturated]~~ or ice-covered or snow-covered ground; ~~[maintenance~~ buffer zones establishment of setback distances], slopes, prohibited access for beef and dairy animals, and soil pH requirements; and proper site specific biosolids loading rates on a field-by-field basis.

9. ~~15.~~ An applicant for a permit authorizing the land application of ~~sewage sludge~~ biosolids shall provide to the department, and to each locality in which the applicant proposes to land apply sewage sludge, biosolids, written evidence of financial responsibility, ~~including both current liability and pollution insurance, or such other evidence of financial responsibility as the board may establish by regulation in an amount not less than \$1 million per occurrence, which shall be available to pay claims for cleanup costs, personal injury, bodily injury and property damage resulting from the transport, storage and land application of sewage sludge in Virginia. The aggregate amount of financial liability to be maintained by the applicant shall be \$1 million for companies with less than \$5 million in annual gross revenue and shall be \$2 million for companies with \$5 million or more in annual gross revenue. Evidence of financial responsibility shall be provided in accordance with requirements specified in Article 6 (9VAC25-32-770 et seq.) of Part IX [(9VAC25-32-303 et seq.)] of the Virginia Pollution Abatement (VPA) Permit Regulation [.]~~

~~10.~~ 16. If sewage sludge from the applicant's facility is placed on a surface disposal site, the applicant must provide the following information:

Regulations

a. The total dry metric tons of sewage sludge from the applicant's facility that is placed on surface disposal sites per 365-day period.

b. The following information for each surface disposal site receiving sewage sludge from the applicant's facility that the applicant does not own or operate:

(1) The site name or number, contact person, mailing address, and telephone number for the surface disposal site; and

(2) The total dry metric tons from the applicant's facility per 365-day period placed on the surface disposal site.

c. The following information for each active sewage sludge unit at each surface disposal site that the applicant owns or operates:

(1) The name or number and the location of the active sewage sludge unit;

(2) The unit's latitude and longitude to the nearest second, and method of determination;

(3) If not already provided, a topographic map (or other map if a topographic map is unavailable) that shows the unit's location;

(4) The total dry metric tons placed on the active sewage sludge unit per 365-day period;

(5) The total dry metric tons placed on the active sewage sludge unit over the life of the unit;

(6) A description of any liner for the active sewage sludge unit, including whether it has a maximum permeability of 1×10^{-7} cm/sec;

(7) A description of any leachate collection system for the active sewage sludge unit, including the method used for leachate disposal, and any federal, state, and local permit number(s) for leachate disposal;

(8) If the active sewage sludge unit is less than 150 meters from the property line of the surface disposal site, the actual distance from the unit boundary to the site property line;

(9) The remaining capacity (dry metric tons) for the active sewage sludge unit;

(10) The date on which the active sewage sludge unit is expected to close, if such a date has been identified;

(11) The following information for any other facility that sends sewage sludge to the active sewage sludge unit:

(a) The name, contact person, and mailing address of the facility; and

(b) Available information regarding the quality of the sewage sludge received from the facility, including any treatment at the facility to reduce pathogens or vector attraction characteristics;

(12) Whether any of the vector attraction reduction options of 9VAC25-31-720 B 9 through 11 is met at the active sewage sludge unit, and a description of any

procedures employed at the time of disposal to reduce vector attraction properties in sewage sludge;

(13) The following information, as applicable to any [groundwater ~~ground-water~~] monitoring occurring at the active sewage sludge unit:

(a) A description of any [groundwater ~~ground-water~~] monitoring occurring at the active sewage sludge unit;

(b) Any available [groundwater ~~ground-water~~] monitoring data, with a description of the well locations and approximate depth to [groundwater ~~ground-water~~];

(c) A copy of any [groundwater ~~ground-water~~] monitoring plan that has been prepared for the active sewage sludge unit;

(d) A copy of any certification that has been obtained from a qualified [groundwater ~~ground-water~~] scientist that the aquifer has not been contaminated; and

(14) If site-specific pollutant limits are being sought for the sewage sludge placed on this active sewage sludge unit, information to support such a request.

~~17.~~ 17. If sewage sludge from the applicant's facility is fired in a sewage sludge incinerator, the applicant must provide the following information:

a. The total dry metric tons of sewage sludge from the applicant's facility that is fired in sewage sludge incinerators per 365-day period.

b. The following information for each sewage sludge incinerator firing the applicant's sewage sludge that the applicant does not own or operate:

(1) The name and/or number, contact person, mailing address, and telephone number of the sewage sludge incinerator; and

(2) The total dry metric tons from the applicant's facility per 365-day period fired in the sewage sludge incinerator.

~~18.~~ 18. If sewage sludge from the applicant's facility is sent to a municipal solid waste landfill (MSWLF), the applicant must provide the following information for each MSWLF to which sewage sludge is sent:

a. The name, contact person, mailing address, location, and all applicable permit numbers of the MSWLF;

b. The total dry metric tons per 365-day period sent from this facility to the MSWLF;

c. A determination of whether the sewage sludge meets applicable requirements for disposal of sewage sludge in a MSWLF, including the results of the paint filter liquids test and any additional requirements that apply on a site-specific basis; and

d. Information, if known, indicating whether the MSWLF complies with criteria set forth in the Solid Waste Management Regulations, 9VAC20-81.

~~13.~~ 19. All applicants must provide the name, mailing address, telephone number, and responsibilities of all contractors responsible for any operational or maintenance aspects of the facility related to biosolids or sewage sludge generation, treatment, use, or disposal.

~~14.~~ 20. At the request of the board, the applicant must provide any other information necessary to determine the appropriate standards for permitting under Part VI (9VAC25-31-420 et seq.) of this chapter, and must provide any other information necessary to assess the ~~sewage sludge~~ biosolids use and sewage sludge disposal practices, determine whether to issue a permit, or identify appropriate permit requirements; and pertinent plans, specifications, maps and such other relevant information as may be required, in scope and details satisfactory to the board.

~~15.~~ 21. All applications must be signed by a certifying official in compliance with 9VAC25-31-110.

Q. R. Applications for facilities with cooling water intake structures.

1. Application requirements. New facilities with new or modified cooling water intake structures. New facilities with cooling water intake structures as defined in 9VAC25-31-165 must report the information required under subdivisions 2, 3, and 4 of this subsection and under 9VAC25-31-165. Requests for alternative requirements under 9VAC25-31-165 must be submitted with the permit application.

2. Source water physical data. These include:

a. A narrative description and scaled drawings showing the physical configuration of all source water bodies used by the facility, including area dimensions, depths, salinity and temperature regimes, and other documentation that supports the determination of the water body type where each cooling water intake structure is located;

b. Identification and characterization of the source water body's hydrological and geomorphologic features, as well as the methods used to conduct any physical studies to determine the intake's area of influence within the water body and the results of such studies; and

c. Location maps.

3. Cooling water intake structure data. These include:

a. A narrative description of the configuration of each cooling water intake structure and where it is located in the water body and in the water column;

b. Latitude and longitude in degrees, minutes, and seconds for each cooling water intake structure;

c. A narrative description of the operation of each cooling water intake structure, including design intake flow, daily hours of operation, number of days of the year in operation and seasonal changes, if applicable;

d. A flow distribution and water balance diagram that includes all sources of water to the facility, recirculation flows and discharges; and

e. Engineering drawings of the cooling water intake structure.

4. Source water baseline biological characterization data. This information is required to characterize the biological community in the vicinity of the cooling water intake structure and to characterize the operation of the cooling water intake structures. The department may also use this information in subsequent permit renewal proceedings to determine if the design and construction technology plan as required in 9VAC25-31-165 should be revised. This supporting information must include existing data if available. Existing data may be supplemented with data from newly conducted field studies. The information must include:

a. A list of the data in subdivisions 4 b through 4 f of this subsection that is not available and efforts made to identify sources of the data;

b. A list of species (or relevant taxa) for all life stages and their relative abundance in the vicinity of the cooling water intake structure;

c. Identification of the species and life stages that would be most susceptible to impingement and entrainment. Species evaluated should include the forage base as well as those most important in terms of significance to commercial and recreational fisheries;

d. Identification and evaluation of the primary period of reproduction, larval recruitment, and period of peak abundance for relevant taxa;

e. Data representative of the seasonal and daily activities (e.g., feeding and water column migration) of biological organisms in the vicinity of the cooling water intake structure;

f. Identification of all threatened, endangered, and other protected species that might be susceptible to impingement and entrainment at the cooling water intake structures;

g. Documentation of any public participation or consultation with federal or state agencies undertaken in development of the plan; and

h. If information requested in subdivision 4 of this subsection is supplemented with data collected using field studies, supporting documentation for the source water baseline biological characterization must include a description of all methods and quality assurance procedures for sampling, and data analysis including a description of the study area; taxonomic identification of sampled and evaluated biological assemblages (including all life stages of fish and shellfish); and sampling and data analysis methods. The sampling and/or data analysis methods used must be appropriate for a quantitative

Regulations

survey and based on consideration of methods used in other biological studies performed within the same source water body. The study area should include, at a minimum, the area of influence of the cooling water intake structure.

~~Note 1: Until further notice subdivision G 7 e (1) of this section and the corresponding portions of the VPDES application Form 2C are suspended as they apply to coal mines.~~

~~Note 2: Until further notice subdivision G 7 e (1) of this section and the corresponding portions of Item V C of the VPDES application Form 2C are suspended as they apply to:~~

~~a. Testing and reporting for all four organic fractions in the Greige Mills Subcategory of the Textile Mills industry (subpart C Low water use processing of 40 CFR Part 410), and testing and reporting for the pesticide fraction in all other subcategories of this industrial category.~~

~~b. Testing and reporting for the volatile, base/neutral and pesticide fractions in the Base and Precious Metals Subcategory of the Ore Mining and Dressing industry (subpart B of 40 CFR Part 440), and testing and reporting for all four fractions in all other subcategories of this industrial category.~~

~~c. Testing and reporting for all four GC/MS fractions in the Porcelain Enameling industry.~~

~~Note 3: Until further notice subdivision G 7 e (1) of this section and the corresponding portions of Item V C of the VPDES application Form 2C are suspended as they apply to:~~

~~a. Testing and reporting for the pesticide fraction in the Tall Oil Rosin Subcategory (subpart D) and Rosin-Based Derivatives Subcategory (subpart F) of the Gum and Wood Chemicals industry (40 CFR Part 454), and testing and reporting for the pesticide and base neutral fractions in all other subcategories of this industrial category.~~

~~b. Testing and reporting for the pesticide fraction in the leather tanning and finishing, paint and ink formulation, and photographic supplies industrial categories.~~

~~c. Testing and reporting for the acid, base/neutral and pesticide fractions in the petroleum refining industrial category.~~

~~d. Testing and reporting for the pesticide fraction in the Papergrade Sulfite Subcategories (subparts J and U) of the Pulp and Paper industry (40 CFR Part 430); testing and reporting for the base/neutral and pesticide fractions in the following subcategories: Deink (subpart Q), Dissolving Kraft (subpart F), and Paperboard from Waste Paper (subpart E); testing and reporting for the volatile, base/neutral and pesticide fractions in the following subcategories: BCT Bleached Kraft (subpart H), Semi-Chemical (subparts B and C), and Nonintegrated Fine Papers (subpart R); and testing and reporting for the acid, base/neutral, and pesticide fractions in the following subcategories: Fine Bleached Kraft (subpart I), Dissolving~~

~~Sulfite Pulp (subpart K), Groundwood Fine Papers (subpart O), Market Bleached Kraft (subpart G), Tissue from Wastepaper (subpart T), and Nonintegrated Tissue Papers (subpart S).~~

~~e. Testing and reporting for the base/neutral fraction in the Once Through Cooling Water, Fly Ash and Bottom Ash Transport Water process wastestreams of the Steam Electric Power Plant industrial category.~~

Part IV Public Involvement

9VAC25-31-260. Draft permits.

A. Once an application is complete, the board shall tentatively decide whether to prepare a draft permit or to deny the application.

B. If the board tentatively decides to deny the permit application, the owner shall be advised of that decision and of the changes necessary to obtain approval. The owner may withdraw the application prior to board action. If the application is not withdrawn or modified to obtain the tentative approval to issue, the board shall provide public notice and opportunity for a public hearing prior to board action on the application.

C. If the board tentatively decides to issue a VPDES general permit, a draft general permit shall be prepared under subsection D of this section.

D. If the board decides to prepare a draft permit, the draft permit shall contain the following information:

1. All conditions under 9VAC25-31-190 and 9VAC25-31-210;
2. All compliance schedules under 9VAC25-31-250;
3. All monitoring requirements under 9VAC25-31-220; and
4. Effluent limitations, standards, prohibitions, standards for biosolids use or sewage sludge ~~use or~~ disposal, and conditions under 9VAC25-31-190, 9VAC25-31-200, 9VAC25-31-220, and Part VI (9VAC25-31-370 et seq.), and all variances that are to be included.

9VAC25-31-280. Fact sheet.

A. A fact sheet shall be prepared for every draft permit for a major VPDES facility or activity, for every Class I sludge management facility, for every VPDES general permit, for every VPDES draft permit that incorporates a variance or requires an explanation under subsection B 8 of this section, for every draft permit that includes a sewage sludge biosolids land application [plan] under [~~9VAC25-31-100 C 2~~ 9VAC25-31-100 D 2], and for every draft permit which the board finds is the subject of wide-spread public interest or raises major issues. The fact sheet shall briefly set forth the principal facts and the significant factual, legal, methodological and policy questions considered in preparing the draft permit. The board shall send this fact sheet to the applicant and, on request, to any other person.

B. The fact sheet shall include, when applicable:

1. A brief description of the type of facility or activity which is the subject of the draft permit;
2. The type and quantity of wastes, fluids, or pollutants which are proposed to be or are being treated, stored, disposed of, injected, emitted, or discharged;
3. A brief summary of the basis for the draft permit conditions including references to applicable statutory or regulatory provisions;
4. Reasons why any requested variances or alternatives to required standards do or do not appear justified;
5. A description of the procedures for reaching a final decision on the draft permit including:
 - a. The beginning and ending dates of the comment period for the draft permit and the address where comments will be received;
 - b. Procedures for requesting a public hearing and the nature of that hearing; and
 - c. Any other procedures by which the public may participate in the final decision;
6. Name and telephone number of a person to contact for additional information;
7. Any calculations or other necessary explanation of the derivation of specific effluent limitations and conditions or standards for biosolids use or sewage sludge use or disposal, including a citation to the applicable effluent limitation guideline, performance standard, or standard for biosolids use or sewage sludge use or disposal and reasons why they are applicable or an explanation of how the alternate effluent limitations were developed;
8. When the draft permit contains any of the following conditions, an explanation of the reasons why such conditions are applicable:
 - a. Limitations to control toxic pollutants;
 - b. Limitations on internal waste streams;
 - c. Limitations on indicator pollutants;
 - d. Technology-based or sewage sludge disposal limitations set on a case-by-case basis;
 - e. Limitations to meet the criteria for permit issuance under 9VAC25-31-50; or
 - f. Waivers from monitoring requirements granted under 9VAC25-31-220 A;
9. For every permit to be issued to a treatment works owned by a person other than a state or municipality, an explanation of the [~~board's~~ board's] decision on regulation of users;
10. When appropriate, a sketch or detailed description of the location of the discharge or regulated activity described in the application; [and]

[~~11. For permits that include a sewage sludge biosolids land application plan under 9VAC25-31-100 P 8 e, a brief description of how each of the required elements of the land application plan are addressed in the permit; and~~

~~12. 11.]~~ Justification of waiver of any application requirements under 9VAC25-31-100 J or P.

9VAC25-31-290. Public notice of permit actions and public comment period.

A. Scope.

1. The ~~board~~ department shall give public notice that the following actions have occurred:
 - a. A draft permit has been prepared under 9VAC25-31-260 D;
 - b. A public hearing has been scheduled under 9VAC25-31-310; or
 - c. A VPDES new source determination has been made under 9VAC25-31-180.
2. No public notice is required when a request for permit modification, revocation and reissuance, or termination is denied under 9VAC25-31-370 B. Written notice of that denial shall be given to the requester and to the permittee.
- ~~3.~~ 3. Public notice shall not be required for submission or approval of plans and specifications or conceptual engineering reports not required to be submitted as part of the application.
- ~~3.~~ 4. Public notices may describe more than one permit or permit actions.

B. Timing.

1. Public notice of the preparation of a draft permit required under subsection A of this section shall allow at least 30 days for public comment.
2. Public notice of a public hearing shall be given at least 30 days before the hearing. (Public notice of the hearing may be given at the same time as public notice of the draft permit and the two notices may be combined.)

C. Methods. Public notice of activities described in subdivision A 1 of this section shall be given by the following methods:

1. By mailing a copy of a notice to the following persons (any person otherwise entitled to receive notice under this subdivision may waive his or her rights to receive notice for any classes and categories of permits):
 - a. The applicant (except for VPDES general permits when there is no applicant);
 - b. Any other agency which the ~~board~~ department knows has issued or is required to issue a VPDES, ~~sludge biosolids~~ sludge biosolids management permit;
 - c. Federal and state agencies with jurisdiction over fish, shellfish, and wildlife resources and over coastal zone management plans, the Advisory Council on Historic

Regulations

Preservation, State Historic Preservation Officers, including any affected states (Indian Tribes);

d. Any state agency responsible for plan development under § 208(b)(2), [§] 208(b)(4) or § 303(e) of the CWA and the U.S. Army Corps of Engineers, the U.S. Fish and Wildlife Service and the National Marine Fisheries Service;

e. Any user identified in the permit application of a privately owned treatment works;

f. Persons on a mailing list developed by:

(1) Including those who request in writing to be on the list;

(2) Soliciting persons for area lists from participants in past permit proceedings in that area; and

(3) Notifying the public of the opportunity to be put on the mailing list through periodic publication in the public press and in such publications as EPA regional and state funded newsletters, environmental bulletins, or state law journals. (The ~~board~~ department may update the mailing list from time to time by requesting written indication of continued interest from those listed. The ~~board~~ department may delete from the list the name of any person who fails to respond to such a request.);

g. (H) Any unit of local government having jurisdiction over the area where the facility is proposed to be located; and

(Z) h. Each state agency having any authority under state law with respect to the construction or operation of such facility;

2. Except for permits for concentrated animal feeding operations as defined in 9VAC25-31-10 or designated in accordance with 9VAC25-31-130 B, by publication once a week for two successive weeks in a newspaper of general circulation in the area affected by the discharge. The cost of public notice shall be paid by the owner; and

3. Any other method reasonably calculated to give actual notice of the action in question to the persons potentially affected by it, including press releases or any other forum or medium to elicit public participation.

D. Contents.

1. All public notices issued under this part shall contain the following minimum information:

a. Name and address of the office processing the permit action for which notice is being given;

b. Name and address of the permittee or permit applicant and, if different, of the facility or activity regulated by the permit, except in the case of VPDES draft general permits;

c. A brief description of the business conducted at the facility or activity described in the permit application or the draft permit, for VPDES general permits when there is no application;

d. Name, address and telephone number of a person from whom interested persons may obtain further information, including copies of the draft permit or draft general permit, as the case may be, statement of basis or fact sheet, and the application;

e. A brief description of the procedures for submitting comments and the time and place of any public hearing that will be held, including a statement of procedures to request a public hearing (unless a hearing has already been scheduled) and other procedures by which the public may participate in the final permit decision;

f. A general description of the location of each existing or proposed discharge point and the name of the receiving water and the [~~sludge biosolids~~] use and [~~sewage sludge~~] disposal practice or practices and the location of each sludge treatment works treating domestic sewage and use or disposal sites known at the time of permit application. For draft general permits, this requirement will be satisfied by a map or description of the permit area;

g. Requirements applicable to cooling water intake structures under § 316 of the CWA, in accordance with 9VAC25-31-165; and

h. Any additional information considered necessary or proper.

2. In addition to the general public notice described in subdivision 1 of this subsection, the public notice of a public hearing under 9VAC25-31-310 shall contain the following information:

a. Reference to the date of previous public notices relating to the permit;

b. Date, time, and place of the public hearing;

c. A brief description of the nature and purpose of the public hearing, including the applicable rules and procedures; and

d. A concise statement of the issues raised by the persons requesting the public hearing.

3. Public notice of a VPDES draft permit for a discharge where a request for alternate thermal effluent limitations has been filed shall include:

a. A statement that the thermal component of the discharge is subject to effluent limitations incorporated in 9VAC25-31-30 and a brief description, including a quantitative statement, of the thermal effluent limitations proposed under § 301 or § 306 of the CWA;

b. A statement that an alternate thermal effluent limitation request has been filed and that alternative less stringent effluent limitations may be imposed on the thermal component of the discharge under the law and § 316(a) of the CWA and a brief description, including a quantitative statement, of the alternative effluent limitations, if any, included in the request; and

c. If the applicant has filed an early screening request for a CWA § 316(a) variance, a statement that the applicant has submitted such a plan.

E. In addition to the general public notice described in subdivision D 1 of this section, all persons identified in subdivisions C 1 a, b, c, and d of this section shall be mailed a copy of the fact sheet or statement of basis, the permit application (if any) and the draft permit (if any).

F. Upon receipt of an application for the issuance of a new or modified permit other than those for agricultural production or aquacultural production activities, the ~~board~~ department shall:

1. Notify, in writing, the locality wherein the discharge or, as applicable, the associated land application of ~~sewage sludge~~ biosolids, or land disposal of treated sewage, stabilized sewage sludge or stabilized septage does or is proposed to take place of, at a minimum:

- a. The name of the applicant;
- b. The nature of the application and proposed discharge;
- c. The availability and timing of any comment period; and
- d. Upon request, any other information known to, or in the possession of, the board or the department regarding the applicant not required to be held confidential by this chapter.

~~2. Establish a date for a public meeting to discuss technical issues relating to proposals for land application of sewage sludge, or land disposal of treated sewage, stabilized sewage sludge or stabilized septage. The department shall give notice of the date, time, and place of the public meeting and a description of the proposal by publication in a newspaper of general circulation in the city or county where the proposal is to take place. Public notice of the scheduled meeting shall occur no fewer than seven or more than 14 days prior to the meeting. The board shall not issue the permit until the public meeting has been held and comment has been received from the local governing body, or until 30 days have lapsed from the date of the public meeting.~~

~~3.~~ 2. Except for land application of ~~sewage sludge~~ biosolids or land disposal of treated sewage, stabilized sewage sludge or stabilized septage, make a good faith effort to provide this same notice and information to (i) each locality and riparian property owner to a distance one-quarter mile downstream and one-quarter mile upstream or to the fall line whichever is closer on tidal waters and (ii) each locality and riparian property owner to a distance one-half mile downstream on nontidal waters. Distances shall be measured from the point, or proposed point, of discharge. If the receiving river at the point or proposed point of discharge is two miles wide or greater, the riparian property owners on the opposite shore need not be notified. Notice to property owners shall be based on names and

addresses taken from local tax rolls. Such names and addresses shall be provided by the commissioners of the revenue or the tax assessor's office of the affected jurisdictions upon request by the board.

~~4. For a site that is to be added to an existing permit authorizing land application of sewage sludge, notify persons residing on property bordering such site and receive written comments from those persons for a period not to exceed 30 days. Based upon the written comments, the department shall determine whether additional site-specific requirements should be included in the authorization for land application at the site.~~

G. Whenever the department receives an application for a new permit for land application of biosolids or land disposal of treated sewage, stabilized sewage sludge, or stabilized septage, or an application to reissue with the addition of sites increasing acreage by 50% or more of that authorized by the initial permit, the department shall establish a date for a public meeting to discuss technical issues relating to proposals for land application of biosolids or land disposal of treated sewage, stabilized sewage sludge, or stabilized septage. The department shall give notice of the date, time, and place of the public meeting and a description of the proposal by publication in a newspaper of general circulation in the city or county where the proposal is to take place. Public notice of the scheduled meeting shall occur no fewer than seven or more than 14 days prior to the meeting. The department shall not issue the permit until the public meeting has been held and comment has been received from the local governing body or until 30 days have lapsed from the date of the public meeting.

H. Following the submission of an application for a new permit for land application of biosolids or land disposal of treated sewage, stabilized sewage sludge, or stabilized septage, [~~DEQ~~ the department] shall [make a good faith effort to] notify or cause to be notified persons residing on property bordering the sites that contain the proposed land application fields. This notification shall be in a manner selected by the department. For the purposes of this subsection, "site" means all contiguous land under common ownership, but which may contain more than one tax parcel.

I. Following the submission of an application to add a site that is not contiguous to sites included in an existing permit authorizing the land application of biosolids:

1. The department shall notify persons residing on property bordering such site and shall receive written comments from those persons for a period of 30 days. Based upon written comments, the department shall determine whether additional site-specific requirements should be included in the authorization for land application at the site.

2. An application for any permit amendment to increase the acreage authorized by the initial permit by 50% or more shall be considered a major modification and shall be treated as a new application for purposes of public notice

Regulations

and public hearings. The increase in acreage for the purpose of determining the need for the public meeting is the sum of all acreage that has been added to the permit since the last public meeting, plus that proposed to be added.

~~G. J.~~ Before issuing any permit, if the [board ~~department~~] finds that there are localities particularly affected by the permit, the [board ~~department~~] shall:

1. Publish, or require the applicant to publish, a notice in a local paper of general circulation in the localities affected at least 30 days prior to the close of any public comment period. Such notice shall contain a statement of the estimated local impact of the proposed permit, which at a minimum shall include information on the specific pollutants involved and the total quantity of each which may be discharged; ~~and.~~

2. Mail the notice to the chief elected official and chief administrative officer and planning district commission for those localities.

~~Written~~ 3. ~~Accept written comments shall be accepted by the board for [at least up to] 15 days after any public hearing on the permit, unless the [board votes department decides] to shorten the period. For the purposes of this section, the term "locality particularly affected" means any locality which bears any identified disproportionate material water quality impact which would not be experienced by other localities.~~

4. For the purposes of this section, consider the term "locality particularly affected" to mean any locality that bears any identified disproportionate material water quality impact that would not be experienced by other localities.

9VAC25-31-390. Modification or revocation and reissuance of permits.

A. Causes for modification. The following are causes for modification but not revocation and reissuance of permits except when the permittee requests or agrees.

1. There are material and substantial alterations or additions to the permitted facility or activity (including a change or changes in the permittee's sludge use or disposal practice) which occurred after permit issuance which justify the application of permit conditions that are different or absent in the existing permit.

2. The department has received new information. Permits may be modified during their terms for this cause only if the information was not available at the time of permit issuance (other than revised regulations, guidance, or test methods) and would have justified the application of different permit conditions at the time of issuance. For VPDES general permits this cause includes any information indicating that cumulative effects on the environment are unacceptable. For new source or new discharger VPDES permits this cause shall include any significant information derived from effluent testing

required on the permit application after issuance of the permit.

3. The standards or regulations on which the permit was based have been changed by promulgation of amended standards or regulations or by judicial decision after the permit was issued. Permits may be modified during their terms for this cause only as follows:

a. For promulgation of amended standards or regulations, when:

(1) The permit condition requested to be modified was based on a promulgated effluent limitation guideline, EPA approved or promulgated water quality standards, or the Secondary Treatment Regulations incorporated by reference in 9VAC25-31-30; and

(2) EPA has revised, withdrawn, or modified that portion of the regulation or effluent limitation guideline on which the permit condition was based, or has approved a state action with regard to a water quality standard on which the permit condition was based; and

(3) A permittee requests modification in accordance with this chapter within 90 days after Federal Register notice of the action on which the request is based;

b. For judicial decisions, a court of competent jurisdiction has remanded and stayed EPA promulgated regulations or effluent limitation guidelines, if the remand and stay concern that portion of the regulations or guidelines on which the permit condition was based and a request is filed by the permittee in accordance with this chapter within 90 days of judicial remand; or

c. For changes based upon modified state certifications of VPDES permits.

4. The board determines good cause exists for modification of a compliance schedule, such as an act of God, strike, flood, or materials shortage or other events over which the permittee has little or no control and for which there is no reasonably available remedy. However, in no case may a VPDES compliance schedule be modified to extend beyond an applicable CWA statutory deadline.

5. When the permittee has filed a request for a variance pursuant to 9VAC25-31-100 L or M within the time specified in this chapter.

6. When required to incorporate an applicable CWA § 307(a) toxic effluent standard or prohibition.

7. When required by the reopener conditions in a permit which are established under 9VAC25-31-220 B or C or 9VAC25-31-800 E.

8. a. Upon request of a permittee who qualifies for effluent limitations on a net basis under 9VAC25-31-230 G.

b. When a discharger is no longer eligible for net limitations as provided in 9VAC25-31-230 G 1 b.

9. As necessary under 9VAC25-31-800 E for a pretreatment program.

10. Upon failure to notify another state whose waters may be affected by a discharge.

11. When the level of discharge of any pollutant which is not limited in the permit exceeds the level which can be achieved by the technology-based treatment requirements appropriate to the permittee.

12. To establish a notification level as provided in 9VAC25-31-220 F.

13. To modify a schedule of compliance to reflect the time lost during construction of an innovative or alternative facility, in the case of a POTW which has received a grant under § 202(a)(3) of the CWA for 100% of the costs to modify or replace facilities constructed with a grant for innovative and alternative wastewater technology under § 202(a)(2) of the CWA. In no case shall the compliance schedule be modified to extend beyond an applicable CWA statutory deadline for compliance.

14. To correct technical mistakes, such as errors in calculation, or mistaken interpretations of law made in determining permit conditions.

15. When the discharger has installed the treatment technology considered by the permit writer in setting effluent limitations imposed under the law and § 402(a)(1) of the CWA and has properly operated and maintained the facilities but nevertheless has been unable to achieve those effluent limitations. In this case, the limitations in the modified permit may reflect the level of pollutant control actually achieved (but shall not be less stringent than required by a subsequently promulgated effluent limitations guideline).

[~~16. When required by a permit condition to incorporate a land application plan for beneficial reuse of sewage sludge biosolids, to revise an existing land application plan, or to add a land application plan.]~~

B. Causes for modification or revocation and reissuance. The following are causes to modify or, alternatively, revoke and reissue a permit:

1. Cause exists for termination under 9VAC25-31-410, and the board determines that modification or revocation and reissuance is appropriate; or

2. The department has received notification of a proposed transfer of the permit. A permit also may be modified to reflect a transfer after the effective date of an automatic transfer but will not be revoked and reissued after the effective date of the transfer except upon the request of the new permittee.

Part VI
Standards for the Use of Biosolids or Disposal of Sewage Sludge

Article 1
General Requirements

9VAC25-31-420. Purpose and applicability.

A. This part establishes standards, which consist of general requirements, pollutant limits, management practices, and operational standards, for the final use of biosolids or disposal of sewage sludge generated during the treatment of domestic sewage in a treatment works. Standards are included in this part for ~~sewage sludge biosolids~~ applied to the land or sewage sludge placed on a surface disposal site. Also included in this part are pathogen and alternative vector attraction reduction requirements for ~~sewage sludge biosolids~~ applied to the land or sewage sludge placed on a surface disposal site.

B. In addition, the standards in this part include the frequency of monitoring and recordkeeping requirements when ~~sewage sludge biosolids~~ is applied to the land or sewage sludge is placed on a surface disposal site. Also included in this part are reporting requirements for Class I sludge management facilities, publicly owned treatment works (POTWs) with a design flow rate equal to or greater than one million gallons per day, and POTWs that serve 10,000 people or more.

~~B.~~ C. Applicability.

1. This part applies to any person who prepares sewage sludge or biosolids, or applies ~~sewage sludge biosolids~~ to the land and to the owner/operator of a surface disposal site.

2. This part applies to ~~sewage sludge biosolids~~ applied to the land or sewage sludge placed on a surface disposal site.

3. This part applies to land where ~~sewage sludge biosolids~~ is applied and to a surface disposal site.

9VAC25-31-440. Permits and direct enforceability.

A. The requirements in this part may be implemented through a permit issued to a treatment works treating domestic sewage, in accordance with this chapter. Treatment works treating domestic sewage shall submit a permit application in accordance with this chapter.

B. No person shall use biosolids or dispose of sewage sludge through any practice for which requirements are established in this part except in accordance with such requirements.

[C. No person shall land apply Class B biosolids on any land in Virginia unless that land has been identified in an application to issue, reissue, or modify a permit and approved by the board.

D. No person shall land apply, market, or distribute biosolids in Virginia unless the biosolids source has been approved by the board.]

Regulations

9VAC25-31-460. Additional or more stringent requirements.

A. On a case-by-case basis, the board may impose requirements for the use of biosolids or disposal of sewage sludge in addition to or more stringent than the requirements in this part when necessary to protect public health and the environment from any adverse effect of a pollutant in the biosolids or sewage sludge.

B. Nothing in this part precludes [the authority of] another state agency [~~with responsibility for regulating biosolids or sewage sludge or~~] any political subdivision of Virginia [~~2~~] or an interstate agency [~~from imposing requirements for the use of biosolids or disposal of sewage sludge more stringent than the requirements in this part or from imposing additional requirements for~~ with respect to] the use of biosolids or disposal of sewage sludge.

C. For ~~sewage sludge~~ biosolids land application where, because of site-specific conditions, including soil type, identified during the permit application review process, the department determines that special requirements are necessary to protect the environment or the health, safety or welfare of persons residing in the vicinity of a proposed land application site, the department may incorporate in the permit at the time it is issued reasonable special conditions regarding [buffering setback distances], transportation routes, slope, material source, methods of handling and application, and time of day restrictions exceeding those required by this regulation. The permit applicant shall have at least 14 days in which to review and respond to the proposed conditions.

9VAC25-31-475. Local enforcement of [~~sewage sludge biosolids~~] regulations.

A. In the event of a dispute concerning the existence of a violation between a permittee and a locality that has adopted a local ordinance for testing and monitoring of the land application of ~~sewage sludge and a permittee concerning the existence of a violation~~ biosolids, the activity alleged to be in violation shall be halted pending a determination by the director. ~~The decision of the director shall be final and binding unless reversed on judicial appeal pursuant to § 2.2-4026 of the Code of Virginia. If the activity is not halted, the director may seek an injunction compelling the halting of the activity from a court having jurisdiction.~~

B. Upon determination by the director that there has been a violation of § 62.1-44.19:3, 62.1-44.19:3.1 or 62.1-44.19:3.3 of the Code of Virginia, or of any regulation promulgated under those sections, and that such violation poses an imminent threat to public health, safety or welfare, the department shall commence appropriate action to abate the violation and immediately notify the chief administrative officer of any locality potentially affected by the violation.

C. Local governments shall promptly notify the department of all results from the testing and monitoring of the land application of ~~sewage sludge~~ biosolids performed by persons employed by local governments and any violation of § 62.1-

44.19:3, 62.1-44.19:3.1, or 62.1-44.19:3.3 of the Code of Virginia.

D. ~~Localities~~ Local governments receiving complaints concerning land application of ~~sewage sludge~~ biosolids shall notify the department and the permit holder within 24 hours of receiving the complaint.

9VAC25-31-480. Requirement Requirements for a person who prepares biosolids or sewage sludge.

A. Any person who prepares biosolids shall ensure that the applicable requirements in this part are met when biosolids is applied to the land.

B. Any person who prepares sewage sludge shall ensure that the applicable requirements in this part are met when the sewage sludge is ~~applied to the land, or~~ placed on a surface disposal site.

9VAC25-31-485. Requirements for [permittees a person] who land [apply applies] sewage sludge biosolids.

A. [~~Any person who land applies sewage sludge biosolids authorized by a VPDES permit shall be certified in accordance with requirements~~ No person shall land apply biosolids pursuant to a permit issued in accordance with this regulation unless an individual holding a valid certificate of competence as] specified in the Virginia Pollution Abatement Permit Regulation (~~9VAC25-32~~), Article 5, Certification of Land Applicators, as set forth in 9VAC25-32-690 through 9VAC25-32-760 [~~is onsite at all times during such land application~~].

B. ~~Persons authorized to land apply sewage sludge under a VPDES permit shall report all complaints received by them to the department and the local governing body of the jurisdiction in which the complaint originates.~~

B. When an application for a permit that authorizes the land application of biosolids is submitted to the department:

1. ~~Permit holders shall use a [unique control number assigned by the department as an identifier for fields permitted for land application. DEQ control number, if previously assigned, identifying each land application field. If a DEQ control number has not been assigned, provide the site identification code used by the permit applicant to report activities and the site's location.]~~

2. A written agreement shall be established between the landowner and permit applicant or permit holder to be submitted with the permit application, whereby the landowner shall consent to the application of biosolids on his property [and certify that no concurrent agreements are in effect for the fields to be permitted for biosolids application]. The landowner agreement shall include [an acknowledgment by the landowner of any site restrictions identified in the permit. The responsibility for obtaining and maintaining the agreements lies with the permit holder.]

(a) A statement certifying that the landowner is the sole owner or one of multiple owners of the property or properties identified on the landowner agreements;

(b) A statement certifying that no concurrent agreements are in effect for the fields to be permitted for biosolids application;

(c) An acknowledgement that the landowner shall notify the permittee when land is sold or ownership transferred;

(d) An acknowledgement that the landowner shall notify the permittee if any conditions change such that any component of the landowner agreement becomes invalid;

(e) Permission to allow department staff on the landowner's property to conduct inspections;

(f) An acknowledgement by the landowner of any site restrictions identified in the regulation;

(g) An acknowledgement that the landowner has received a biosolids fact sheet approved by the department; and

(h) An acknowledgement that the landowner shall not remove notification signs placed by the permit holder.]

3. New [~~or revised~~] landowner agreements [, using the most current form provided by the board,] shall be submitted to the department [~~if new land is being added to the permit or if there have been changes in ownership of land included in a permit reissuance request for proposed land application sites identified in each application for issuance or reissuance of a permit or the modification to add land to an existing permit that authorizes the land application of biosolids~~].

[4. For permits modified in order to incorporate changes to this chapter, the permit holder shall, within 60 days of the effective date of the permit modification, advise the landowner by certified letter of the requirement to provide a new landowner agreement. The letter shall include instructions to the landowner for signing and returning the new landowner agreement and shall advise the landowner that the permit holder's receipt of such new landowner agreement is required prior to application of biosolids to the landowner's property.

5. The responsibility for obtaining and maintaining the agreements lies with the permit holder.]

C. The permit holder shall ensure that the landowner agreement is still valid at the time of land application.

D. Notification requirements.

~~1.~~ At least 100 days prior to commencing [the first] land application of ~~sewage sludge~~ biosolids at a permitted site the permittee shall deliver or cause to be delivered written notification to the chief executive officer or his designee for the local government where the site is located. The notice shall identify the location of the permitted site and the expected sources of the ~~sewage sludge~~ biosolids to be applied to the site. This requirement may be satisfied by [the department's notice to the local government at the

time of receiving the permit application if all necessary information is included in the notice or by] providing a list of all available permitted sites in the locality at least 100 days prior to commencing the application at any site on the list. If the site is located in more than one county, the notice shall be provided to all jurisdictions where the site is located.

2. At least 14 days prior to commencing land application of biosolids at a permitted site, the permit holder shall deliver or cause to be delivered written notification to the department and the chief executive officer or designee for the local government where the site is located [~~The notice shall include the following:~~ unless they request in writing not to receive the notice. The notice shall identify the location of the permitted site and the expected sources of the sewage sludge to be applied to the site.]

[~~a. The name, address, and telephone number of the permit holder, including the name of a representative knowledgeable of the permit;~~

~~b. Identification by tax map number and the DEQ control number for sites on which land application is to take place;~~

~~c. A map indicating haul routes on each site where land application is to take place;~~

~~d. The name or title and phone number of at least one individual designated by the permit holder to respond to questions and complaints related to the land application project;~~

~~e. The approximate dates on which land application is to begin and end at the site;~~

~~f. The name and telephone number of the person or persons at the department to be contacted in connection with the permit; and~~

~~g. The name, address, and telephone number of the wastewater treatment facility, or facilities, from which the biosolids will originate, including the name or title of a representative of the treatment facility that is knowledgeable about the land application operation.~~

If multiple sites are included in the notification, the permit holder shall make a good faith effort to identify the most probable order that land application will commence.]

~~3.~~ [The Not more than 24 hours prior to commencing land application activities, including delivery of biosolids at a permitted site, the] permittee shall [~~deliver or cause to be delivered written notification to~~ notify in writing] the department as least 14 days prior to commencing land application of sewage sludge at a permitted site. The notice shall identify the location of the permitted site and the expected sources of the sewage sludge to be applied to the site and [~~to~~] the chief executive officer or designee for the local government where the site is located [~~daily notification prior to commencing planned land application activities.~~ unless they request in writing not to receive the

Regulations

notice. This notification shall include identification of the biosolids source and shall include only sites where land application activities will commence within 24 hours or where the biosolids will be staged within 24 hours.]

E. The permittee shall provide to the department, and to each locality in which it is permitted to land apply sewage sludge, written evidence of financial responsibility, including both current liability and pollution insurance, or such other evidence of financial responsibility as the board may establish by regulation in an amount not less than \$1 million per occurrence, which shall be available to pay claims for cleanup costs, personal injury, bodily injury and property damage resulting from the transport, storage and land application of sewage sludge in Virginia. The aggregate amount of financial liability maintained by the permittee shall be \$1 million for companies with less than \$5 million in annual gross revenue and shall be \$2 million for companies with \$5 million or more in annual gross revenue. Evidence of financial responsibility shall be provided in accordance with requirements specified in Article 6 (9VAC25-32-770 et seq.) of Part IX [(9VAC25-32-303 et seq.)] of the Virginia Pollution Abatement (VPA) Permit Regulation.

F. Posting signs.

1. At least five business days prior to delivery of biosolids for land application on any site permitted under this regulation, the permit holder shall post signs at the site that comply with this section, are visible and legible from the public right-of-way in both directions of travel, and conform to the specifications [herein in this subsection]. The sign shall remain in place for at least five business days after land application has been completed at the site. [The permit holder shall not remove the signs until at least 30 days after land application has been completed at the site.]

a. [A sign shall be posted at or near the intersection of the public right-of-way and the main site access road or driveway to the site used by the biosolids transport vehicles.

b.] If the [site field] is located adjacent to a public right-of-way, [signs at least one sign] shall be posted along each [public] road frontage beside the field to be land applied.

[b. If the site is not located adjacent to a public right of way, the sign shall be posted at or near the intersection of the public right of way and the main site access road or driveway to the site.]

c. The department may grant a waiver to the requirements in this section, or require alternative posting options due to extenuating circumstances or [to be consistent where requirements conflict] with local government ordinances and other requirements regulating the use of signs.

2. [Upon the posting of signs at a land application site prior to commencing land application, the permittee shall deliver or cause to be delivered written notification to the department and the chief executive officer or designee for the local government where the site is located unless they request in writing not to receive the notice. Notification shall be delivered to the department within 24 hours of the posting of the signs. The notice shall include the following:

a. The name and telephone number of the permit holder, including the name of a representative knowledgeable of the permit;

b. Identification by tax map number and the DEQ control number for sites on which land application is to take place;

c. The name or title and telephone number of at least one individual designated by the permit holder to respond to questions and complaints related to the land application project if not the permit holder identified in subdivision a of this subdivision; and

d. The approximate dates on which land application is to begin and end at the site.

3.] The sign shall be made of weather-resistant materials and shall be sturdily mounted so as to be capable of remaining in place and legible throughout the period that the sign is required at the site. Signs required by this section shall be temporary, nonilluminated, and four square feet or more in area, and only contain the following information:

a. A statement that biosolids are being land applied at the site;

b. The name [and telephone number] of the permit holder [and the name (or title) and telephone number of an individual designated by the permit holder to respond to complaints and inquiries; and;

c. The telephone number of an individual designated by the permit holder to respond to complaints and inquiries; and]

[e. d.] Contact information for the department, including a telephone number for complaints and inquiries.

[3. 4.] The permit holder shall make a good faith effort to replace or repair any sign that has been removed from a land application site or that has been damaged so as to render any of its required information illegible prior to five business days after completion of land application.

G. [Operations Biosolids] management plan.

1. The permit holder shall maintain [an operations and implement a biosolids] management plan, which shall consist of three components:

a. The materials, including site booklets, developed and submitted at the time of permit application or permit modification adding a site to the permit in accordance with 9VAC25-31-100 Q;

b. Nutrient management plan for each site, in accordance with 9VAC25-31-505; and

c. Operation and maintenance (O&M) manual, developed and submitted to the department within 90 days of the effective date of the permit.

[2. The biosolids management plan and all of its components shall be incorporated as an enforceable part of the permit.]

[2. 3.] The O&M manual shall include at a minimum:

a. Equipment maintenance and calibration procedures and schedules;

b. Storage facility maintenance procedures and schedules;

c. Sampling schedules for:

(1) Required monitoring; and

(2) Operational control testing;

d. Sample collection, preservation and analysis procedures, including laboratories and methods used; and

e. Instructions for recording and reporting all monitoring activities.

[3. 4.] Current VPDES permit holders who land apply biosolids may use their existing VPDES O&M plan addressing land application to satisfy the requirements of this section if the existing plan addresses all of the required minimum components identified in this section.

H. Handling of complaints.

1. Within 24 hours of receiving notification of a complaint, the permit holder shall commence investigation of the complaint and shall determine whether the complaint is substantive. The permit holder shall confirm receipt of all substantive complaints by phone, email, or facsimile to the department, the chief executive officer or designee for the local government of the jurisdiction in which the complaint originates, and the owner of the treatment facility from which the biosolids originated within 24 hours after receiving the complaint.

2. For the purposes of this section, a substantive complaint shall be deemed to be any complaint alleging a violation of these regulations, state law, or local ordinance; a release of biosolids to state waters or to a public right-of-way or to any location not authorized in the permit; or failure to comply with the nutrient management plan for the land application site.

9VAC25-31-490. Sampling and analysis.

A. Representative samples of ~~sewage sludge biosolids~~ that is applied to the land, or placed on a surface disposal site shall be collected and analyzed.

B. Methods in the materials listed below [or in 40 CFR Part 136] shall be used to analyze samples of ~~sewage sludge biosolids~~ and calculation procedures in the materials shall be

used to calculate the percent volatile solids reduction for ~~sewage sludge biosolids~~.

1. Enteric viruses.

ASTM Designation: D 4994-89, "Standard Practice for Recovery of Viruses From Wastewater Sludges," Annual Book of ASTM Standards: Section 11 - Water and Environmental Technology, ASTM, Philadelphia, PA., 1992.

2. Fecal coliform.

Part 9221 E. or Part 9222 D., "Standard Methods for the Examination of Water and Wastewater," 18th Edition, American Public Health Association, Washington, D.C., 1992.

3. Helminth ova.

Yanko, W.A., "Occurrence of Pathogens in Distribution and Marketing Municipal Sludges," EPA 600/1-87-014, 1987. PB 88-154273/AS, National Technical Information Service, Springfield, Virginia.

4. Inorganic pollutants.

"Test Methods for Evaluating Solid Waste, Physical/Chemical Methods," EPA Publication SW-846, Third Edition as amended by Final Updates I, II, IIA, IIB, III, IIIA, IIIB, IVA and IVB. PB88-239223, National Technical Information Service, Springfield, Virginia.

5. Salmonella sp. bacteria.

Part 9260 D., "Standard Methods for the Examination of Water and Wastewater," 18th Edition, American Public Health Association, Washington, D.C., 1992; or

Kenner, B.A. and H.P. Clark, "Detection and enumeration of Salmonella and Pseudomonas aeruginosa," J. Water Pollution Control Federation, 46(9):2163-2171, 1974.

6. Specific oxygen uptake rate.

Part 2710 B., "Standard Methods for the Examination of Water and Wastewater," 18th Edition, American Public Health Association, Washington, D.C., 1992.

7. Total, fixed, and volatile solids.

Part 2540 G., "Standard Methods for the Examination of Water and Wastewater," 18th Edition, American Public Health Association, Washington, D.C., 1992.

8. Percent volatile solids reduction calculation.

"Environmental Regulations and Technology - Control of Pathogens and Vector Attraction in Sewage Sludge," EPA-625/R-92/013, U.S. Environmental Protection Agency, Cincinnati, Ohio, Revised July 2003.

9VAC25-31-500. Definitions.

In addition to the definitions given in Part I (9VAC25-31-10 et seq.) of this chapter, the following definitions apply to Part VI (9VAC25-31-420 et seq.) of this chapter. Where the same term is defined in both parts, the definition of Part VI of this

Regulations

chapter applies to the use of the term in Part VI of this chapter.

"Active sewage sludge unit" means a sewage sludge unit that has not closed.

"Aerobic digestion" means the biochemical decomposition of organic matter in sewage sludge into carbon dioxide and water by microorganisms in the presence of air.

"Agricultural land" means land on which a food crop, a feed crop, or a fiber crop is grown. This includes range land and land used as pasture.

"Agronomic rate" means the whole sludge application rate (dry weight basis) designed: (i) to provide the amount of nitrogen needed by the food crop, feed crop, fiber crop, cover crop, or vegetation grown on the land and (ii) to minimize the amount of nitrogen in the ~~sewage sludge biosolids~~ that passes below the root zone of the crop or vegetation grown on the land to the [groundwater ~~ground water~~].

"Anaerobic digestion" means the biochemical decomposition of organic matter in sewage sludge into methane gas and carbon dioxide by microorganisms in the absence of air.

"Annual pollutant loading rate (~~APLR~~) ["] or "APLR" means the maximum amount of a pollutant that can be applied to a unit area of land during a 365-day period.

"Annual whole sludge application rate (~~AWSAR~~)" or "AWSAR" means the maximum amount of ~~sewage sludge biosolids~~ (dry weight basis) that can be applied to a unit area of land during a 365-day period.

"Apply ~~sewage sludge biosolids~~" or ~~sewage sludge biosolids~~ applied to the land" means land application of ~~sewage sludge biosolids~~.

"Aquifer" means a geologic formation, group of geologic formations, or a portion of a geologic formation capable of yielding [groundwater ~~ground water~~] to wells or springs.

"Base flood" means a flood that has a one percent chance of occurring in any given year (i.e., a flood with a magnitude equaled once in 100 years).

[~~"Biosolids" means a sewage sludge that has received an established treatment and is managed in a manner to meet the required pathogen control and vector attraction reduction, and contains concentrations of regulated pollutants below the ceiling limits established in 40 CFR Part 503 and 9VAC25-31-540, such that it meets the standards established for use of biosolids for land application, marketing, or distribution in accordance with this regulation.~~]

~~"Bulk sewage sludge"~~ "Bulk biosolids" means ~~sewage sludge biosolids~~ that is are not sold or given away in a bag or other container for application to the land.

"Class I sludge management facility" means any publicly owned treatment works (POTW) required to have an approved pretreatment program under this chapter and any treatment works treating domestic sewage classified as a

Class I sludge management facility by the board because of the potential for its biosolids use or sewage sludge ~~use or~~ disposal practice to affect public health and the environment adversely.

"Contaminate an aquifer" means to introduce a substance that causes the maximum contaminant level for nitrate in the Virginia Water Quality Standards or in 40 CFR 141.62(b) to be exceeded in [groundwater ~~ground water~~] or that causes the existing concentration of nitrate in [groundwater ~~ground water~~] to increase when the existing concentration of nitrate in the [groundwater ~~ground water~~] exceeds the maximum contaminant level for nitrate in the Virginia Water Quality Standards or 40 CFR 141.62(b).

"Cover" means soil or other material used to cover sewage sludge placed on an active sewage sludge unit.

[~~"Cover crop" means a small grain crop, such as oats, wheat, or barley, not grown for harvest.~~]

"Cumulative pollutant loading rate" means the maximum amount of an inorganic pollutant that can be applied to an area of land.

"Density of microorganisms" means the number of microorganisms per unit mass of total solids (dry weight) in the biosolids or sewage sludge.

"Displacement" means the relative movement of any two sides of a fault measured in any direction.

"Domestic septage" means either liquid or solid material removed from a septic tank, cesspool, portable toilet, Type III marine sanitation device, or similar treatment works that receives only domestic sewage. Domestic septage does not include liquid or solid material removed from a septic tank, cesspool, or similar treatment works that receives either commercial wastewater or industrial wastewater and does not include grease removed from a grease trap at a restaurant.

"Domestic sewage" means waste and wastewater from humans or household operations that is discharged to or otherwise enters a treatment works.

"Dry tons" means dry weight established as representative of land applied biosolids and expressed in units of English tons.

"Dry weight" means the measured weight of a sample of sewage sludge or biosolids after all moisture has been removed in accordance with the standard methods of testing and often represented as percent solids.

"Dry weight basis" means calculated on the basis of having been dried at 105°C until reaching a constant mass (i.e., essentially 100% solids content).

"Exceptional quality biosolids" means biosolids that have received an established level of treatment for pathogen control and vector attraction reduction and contain known levels of pollutants, such that they may be marketed or distributed for public use in accordance with this regulation.

"Fault" means a fracture or zone of fractures in any materials along which strata on one side are displaced with respect to strata on the other side.

"Feed crops" means crops produced primarily for consumption by animals.

"Fiber crops" means crops such as flax and cotton.

"Field" means an area of land within a site where land application is proposed or permitted.

"Final cover" means the last layer of soil or other material placed on a sewage sludge unit at closure.

"Food crops" means crops [~~consumed~~ produced primarily for consumption] by humans. These include, but are not limited to, fruits, vegetables, and tobacco.

"Forest" means a tract of land thick with trees and underbrush.

["~~Groundwater~~ "Ground-water"] means water below the land surface in the saturated zone.

"Holocene time" means the most recent epoch of the Quaternary period, extending from the end of the Pleistocene epoch to the present.

"Industrial wastewater" means wastewater generated in a commercial or industrial process.

["~~Land application~~" means ~~the spraying or spreading of sewage sludge biosolids onto the land surface; the injection of sewage sludge biosolids below the land surface; or the incorporation of sewage sludge biosolids into the soil so that the sewage sludge biosolids can either condition the soil or fertilize crops or vegetation grown in the soil. in regard to biosolids, the distribution of biosolids by spreading or spraying on the surface of the land, injecting below the surface of the land, or incorporating into the soil with a uniform application rate for the purpose of fertilizing the crops and vegetation or conditioning the soil. Sites approved for land application of biosolids in accordance with this chapter are not to be considered to be treatment works. Bulk disposal of stabilized sludge in a confined area, such as in landfills, is not land application. For the purpose of this chapter, the use of biosolids in agricultural research and the distribution and marketing of exceptional quality biosolids are not land application.~~

"Land application area" means, in regard to biosolids, the area in the permitted field, excluding the setback distances, where the biosolids may be applied.

"Land applier" means someone who land applies biosolids pursuant to a valid permit from the department as set forth in this chapter and 9VAC25-32-690 through 9VAC25-32-760.]

"Land with a high potential for public exposure" means land that the public uses frequently. This includes, but is not limited to, a public contact site and a reclamation site located in a populated area (e.g., a construction site located in a city).

"Land with a low potential for public exposure" means land that the public uses infrequently. This includes, but is not

limited to, agricultural land, forest, and a reclamation site located in an unpopulated area (e.g., a strip mine located in a rural area).

"Leachate collection system" means a system or device installed immediately above a liner that is designed, constructed, maintained, and operated to collect and remove leachate from a sewage sludge unit.

"Liner" means soil or synthetic material that has a hydraulic conductivity of ~~1×10^{-6}~~ 1×10^{-7} centimeters per second or less.

"Local monitor" means a person or persons employed by a local government to perform the duties of monitoring the operations of land appliers pursuant to a local ordinance.

"Local ordinance" means an ordinance adopted by counties, cities, or towns in accordance with § 62.1-44.19:3 of the Code of Virginia.

"Lower explosive limit for methane gas" means the lowest percentage of methane gas in air, by volume, that propagates a flame at 25°C and atmospheric pressure.

["~~Malodor~~" means ~~an unusually strong or offensive odor associated with biosolids or sewage sludge as distinguished from odors normally associated with biosolids or sewage sludge.~~]

"Monthly average" means the arithmetic mean of all measurements taken during the month.

"Municipality" means a city, town, county, district, association, or other public body (including an intermunicipal Agency of two or more of the foregoing entities) created by or under state law; an Indian tribe or an authorized Indian tribal organization having jurisdiction over sewage sludge management; or a designated and approved management agency under § 208 of the CWA, as amended. The definition includes a special district created under state law, such as a water district, sewer district, sanitary district, utility district, drainage district, or similar entity, or an integrated waste management facility as defined in § 201(e) of the CWA, as amended, that has as one of its principal responsibilities the treatment, transport, use, or disposal of biosolids or sewage sludge.

"Odor sensitive receptor" means, in the context of land application of biosolids, [any health care facility, such as hospitals, convalescent homes, etc. or] a building or outdoor facility regularly used to host or serve large groups of people such as schools, dormitories, [or] athletic and other recreational facilities [, hospitals, and convalescent homes] .

"Other container" means either an open or closed receptacle. This includes, but is not limited to, a bucket, a box, a carton, and a vehicle or trailer with a load capacity of one metric ton or less.

"Pasture" means land on which animals feed directly on feed crops such as legumes, grasses, grain stubble, or stover.

Regulations

"Pathogenic organisms" means disease-causing organisms. These include, but are not limited to, certain bacteria, protozoa, viruses, and viable helminth ova.

"Person who prepares [~~sewage sludge biosolids~~]" means either the person who generates [~~sewage sludge biosolids~~] during the treatment of domestic sewage in a treatment works or the person who derives a material from sewage sludge.

"pH" means the logarithm of the reciprocal of the hydrogen ion concentration measured at 25° Celsius or measured at another temperature and then converted to an equivalent value at 25° Celsius.

"Place sewage sludge or sewage sludge placed" means disposal of sewage sludge on a surface disposal site.

"Pollutant" means an organic substance, an inorganic substance, a combination of organic and inorganic substances, or a pathogenic organism that, after discharge and upon exposure, ingestion, inhalation, or assimilation into an organism either directly from the environment or indirectly by ingestion through the food chain, could, on the basis of information available to the board, cause death, disease, behavioral abnormalities, cancer, genetic mutations, physiological malfunctions (including malfunction in reproduction), or physical deformations in either organisms or offspring of the organisms.

"Pollutant limit" means a numerical value that describes the amount of a pollutant allowed per unit amount of ~~sewage sludge biosolids~~ (e.g., milligrams per kilogram of total solids); the amount of a pollutant that can be applied to a unit area of land (e.g., kilograms per hectare); or the volume of a material that can be applied to a unit area of land (e.g., gallons per acre).

"Public contact site" means land with a high potential for contact by the public. This includes, but is not limited to, public parks, ball fields, cemeteries, ~~plant nurseries, turf farms,~~ and golf courses.

"Qualified [~~groundwater ground-water~~] scientist" means an individual with a baccalaureate or post-graduate degree in the natural sciences or engineering who has sufficient training and experience in [~~groundwater ground-water~~] hydrology and related fields, as may be demonstrated by state registration, professional certification, or completion of accredited university programs, to make sound professional judgments regarding [~~groundwater ground-water~~] monitoring, pollutant fate and transport, and corrective action.

"Range land" means open land with indigenous vegetation.

"Reclamation site" means drastically disturbed land that is reclaimed using ~~sewage sludge biosolids~~. This includes, but is not limited to, strip mines and construction sites.

"Run-off" means rainwater, leachate, or other liquid that drains overland on any part of a land surface and runs off of the land surface.

"Seismic impact zone" means an area that has a 10% or greater probability that the horizontal ground level

acceleration of the rock in the area exceeds 0.10 gravity once in 250 years.

"Sewage sludge" means solid, semi-solid, or liquid residue generated during the treatment of domestic sewage in a treatment works. Sewage sludge includes, but is not limited to, domestic septage; scum or solids removed in primary, secondary, or advanced wastewater treatment processes; and a material derived from sewage sludge. Sewage sludge does not include ash generated during the firing of sewage sludge in a sewage sludge incinerator or grit and screenings generated during preliminary treatment of domestic sewage in a treatment works.

"Sewage sludge unit" means land on which only sewage sludge is placed for final disposal. This does not include land on which sewage sludge is either stored or treated. Land does not include surface waters.

"Sewage sludge unit boundary" means the outermost perimeter of an active sewage sludge unit.

"Site" means the area of land within a defined boundary where an activity is proposed or permitted.

"Specific oxygen uptake rate (SOUR)" means the mass of oxygen consumed per unit time per unit mass of total solids (dry weight basis) in the sewage sludge.

"Store or storage of sewage sludge" means the placement of sewage sludge on land on which the sewage sludge remains for two years or less. This does not include the placement of sewage sludge on land for treatment.

"Surface disposal site" means an area of land that contains one or more active sewage sludge units.

"Total solids" means the materials in sewage sludge that remain as residue when the sewage sludge is dried at 103°C to 105°C.

"Treat or treatment of sewage sludge" means the preparation of sewage sludge for final use or disposal. This includes, but is not limited to, thickening, stabilization, and dewatering of sewage sludge. This does not include storage of sewage sludge.

"Treatment works" means either a federally owned, publicly owned, or privately owned device or system used to treat (including recycle and reclaim) either domestic sewage or a combination of domestic sewage and industrial waste of a liquid nature.

"Unstable area" means land subject to natural or human-induced forces that may damage the structural components of an active sewage sludge unit. This includes, but is not limited to, land on which the soils are subject to mass movement.

"Unstabilized solids" means organic materials in sewage sludge that have not been treated in either an aerobic or anaerobic treatment process.

["Use" means to manage or recycle a processed waste product in a manner so as to derive a measurable benefit as a result of such management.]

"Vector attraction" means the characteristic of biosolids or sewage sludge that attracts rodents, flies, mosquitoes, or other organisms capable of transporting infectious agents.

"Volatile solids" means the amount of the total solids in sewage sludge lost when the sewage sludge is combusted at 550°C in the presence of excess air.

Article 2

~~Sewage Sludge~~ Biosolids Applied to the Land

9VAC25-31-505. Universal requirements for land application operations.

A. A nutrient management plan prepared by a person who is certified as a nutrient management planner by the Department of Conservation and Recreation shall be developed for all application sites prior to ~~sewage sludge biosolids~~ land application.

[1.] A nutrient management plan approved by the Department of Conservation and Recreation shall be required for application sites prior to board authorization under specific conditions, including but not limited to [sites;

a. Sites] operated by an owner or lessee of a confined animal feeding operation, as defined in subsection A of § 62.1-44.17:1 of the Code of Virginia, or confined poultry feeding operation, as defined in subsection A of § 62.1-44.17:1.1 of the Code of Virginia;

[~~sites~~ b. Sites] where land application more frequently than once every three years at greater than 50% of the annual agronomic rate is proposed; [~~and other~~

c. Mined or disturbed land sites where land application is proposed at greater than agronomic rates; and

d. Other] sites based on site-specific conditions that increase the risk that land application may adversely impact state waters.

[e. Where conditions at the land application site change so that it meets one or more of the specific conditions identified in this section, an approved nutrient management plan shall be submitted prior to any future land application at the site.

2. The nutrient management plan shall be available for review by the department at the land application site during biosolids land application.

3. Within 30 days after land application at the site has commenced, the permit holder shall provide a copy of the nutrient management plan to the farm operator of the site, the Department of Conservation and Recreation, and the chief executive officer or designee for the local government unless they request in writing not to receive the nutrient management plan.

4. The nutrient management plan must be approved by the Department of Conservation and Recreation prior to land application for land application sites where the soil test phosphorus levels exceed the values in Table 1 of this

section. For purposes of approval, permittees should submit the nutrient management plan to the Department of Conservation and Recreation at least 30 days prior to the anticipated date of land application to ensure adequate time for the approval process.

TABLE 1
SOIL PHOSPHORUS LEVELS REQUIRING
NMP APPROVAL

<u>Region</u>	<u>Soil Test P (ppm)</u> <u>VPI & SU Test</u> <u>(Mehlich D)*</u>
<u>Eastern Shore and Lower Coastal Plain</u>	<u>135</u>
<u>Middle and Upper Coastal Plain and Piedmont</u>	<u>136</u>
<u>Ridge and Valley</u>	<u>162</u>
<u>*If results are from another laboratory, the Department of Conservation and Recreation approved conversion factors must be used.]</u>	

B. Sewage sludge shall be treated to meet standards for land application of biosolids as required by Part VI (9VAC25-31-420 et seq.) of this chapter prior to delivery at the land application site. No person shall alter the composition of ~~sewage sludge biosolids~~ at a site approved for land application of ~~sewage sludge biosolids~~ under a [~~Virginia Pollution Abatement Permit~~ VPDES permit]. Any person who engages in the alteration of such ~~sewage sludge biosolids~~ shall be subject to the penalties provided in Article 6 (§ 62.1-44.31 et seq.) of Chapter 3.1 of Title 62.1 of the Code of Virginia. The addition of lime or deodorants to ~~sewage sludge biosolids~~ that have been treated to meet standards for land application as required by Part VI (9VAC25-31-420 et seq.) of this chapter, shall not constitute alteration of the composition of ~~sewage sludge biosolids~~. The board may authorize public institutions of higher education to conduct scientific research on the composition of ~~sewage sludge biosolids~~ that may be applied to land.

C. Bulk biosolids [meeting Class B pathogen reduction standards] shall be land applied in accordance with the Virginia Pollution Abatement Permit Regulation, Article 3, Biosolids Use Standards and Practices, set forth in 9VAC25-32-490 through [~~9VAC25-32-660~~ 9VAC25-32-580].

~~C. D.~~ Surface incorporation may be required on cropland by the department, or the local monitor with approval of the department, to mitigate [~~excessive odors~~ malodors], when incorporation is practicable and compatible with a soil conservation plan [or contract] meeting the standards and specifications of the U.S. Department of Agriculture Natural Resources Conservation Service.

Regulations

~~D. E.~~ For applications where surface applied ~~sewage sludge biosolids~~ are not incorporated, the department (or the local monitor with approval of the department) may require as a site-specific permit condition, extended [~~buffer zone~~] setback distances when necessary to protect odor sensitive receptors. ~~When necessary, buffer zone setback distances from odor sensitive receptors may be extended to 400 feet or more and no sewage sludge shall be applied within such extended buffer zones. The board, in accordance with 9VAC25-31-460, may impose standards and requirements that are more stringent when required to protect public health and the environment, or prevent nuisance conditions from developing, either prior to or during sewage sludge use operations.~~

~~E. F.~~ No person shall apply to the Department of Environmental Quality for a permit, a variance, or a permit modification authorizing storage of sewage sludge or biosolids without first complying with all requirements adopted pursuant to § 62.1-44.19:3 R of the Code of Virginia.

9VAC25-31-510. Applicability; bulk ~~sewage sludge biosolids~~; ~~sewage sludge biosolids~~ sold or given away in a bag or other container for application to the land.

A. This [~~subpart article~~] applies to any person who prepares ~~sewage sludge biosolids~~ that is applied to the land, to any person who applies ~~sewage sludge biosolids~~ to the land, to ~~sewage sludge biosolids~~ applied to the land, and to the land on which ~~sewage sludge biosolids~~ is applied.

B. General requirements for bulk biosolids.

~~B. 1.~~ The general requirements in 9VAC25-31-530 and the management practices in 9VAC25-31-550 [~~B through F~~] do not apply when bulk ~~sewage sludge biosolids~~ is applied to the land if the bulk ~~sewage sludge biosolids~~ meets the ceiling concentrations in 9VAC25-31-540 B 1, the pollutant concentrations in 9VAC25-31-540 B 3, the Class A pathogen requirements in 9VAC25-31-710 A, and one of the vector attraction reduction requirements in 9VAC25-31-720 B 1 through B 8.

2. The board may apply any or all of the general requirements in 9VAC25-31-530 and the management practices in 9VAC25-31-550 to the bulk ~~sewage sludge biosolids~~ in subdivision 1 of this subsection on a case-by-case basis after determining that the general requirements or management practices are needed to protect public health and the environment from any reasonably anticipated adverse effect that may occur from any pollutant in the bulk ~~sewage sludge biosolids~~.

C. General requirements for bulk material derived from biosolids.

~~C. 1.~~ The general requirements in 9VAC25-31-530 and the management practices in 9VAC25-31-550 [~~B through F~~] do not apply when a bulk material derived from ~~sewage sludge biosolids~~ is applied to the land if the derived bulk material meets the ceiling concentrations in 9VAC25-31-

540 B 1, the pollutant concentrations in 9VAC25-31-540 B 3, the Class A pathogen requirements in 9VAC25-31-710 A, and one of the vector attraction reduction requirements in 9VAC25-31-720 B 1 through B 8.

2. The board may apply any or all of the general requirements in 9VAC25-31-530 or the management practices in 9VAC25-31-550 to the bulk material in subdivision 1 of this subsection on a case-by-case basis after determining that the general requirements or management practices are needed to protect public health and the environment from any reasonably anticipated adverse effect that may occur from any pollutant in the bulk ~~sewage sludge biosolids~~.

D. The requirements in this article do not apply when a bulk material derived from ~~sewage sludge biosolids~~ is applied to the land if the ~~sewage sludge biosolids~~ from which the bulk material is derived meets the ceiling concentrations in 9VAC25-31-540 B 1, the pollutant concentrations in 9VAC25-31-540 B 3, the Class A pathogen requirements in 9VAC25-31-710 A, and one of the vector attraction reduction requirements in 9VAC25-31-720 B 1 through B 8.

E. The general requirements in 9VAC25-31-530 and the management practices in 9VAC25-31-550 [~~B through F~~] do not apply when ~~sewage sludge biosolids~~ is sold or given away in a bag or other container for application to the land if the ~~sewage sludge biosolids~~ sold or given away in a bag or other container for application to the land meets the ceiling concentrations in 9VAC25-31-540 B 1, the pollutant concentrations in 9VAC25-31-540 B 3, the Class A pathogen requirements in 9VAC25-31-710 A, and one of the vector attraction reduction requirements in 9VAC25-31-720 B 1 through B 8.

F. The general requirements in 9VAC25-31-530 and the management practices in 9VAC25-31-550 [~~B through F~~] do not apply when a material derived from ~~sewage sludge biosolids~~ is sold or given away in a bag or other container for application to the land if the derived material meets the ceiling concentrations in 9VAC25-31-540 B 1, the pollutant concentrations in 9VAC25-31-540 B 3, the Class A pathogen requirements in 9VAC25-31-710 A, and one of the vector attraction reduction requirements in 9VAC25-31-720 B 1 through B 8.

G. The requirements in this [~~subpart article~~] do not apply when a material derived from ~~sewage sludge biosolids~~ is sold or given away in a bag or other container for application to the land if the ~~sewage sludge biosolids~~ from which the material is derived meets the ceiling concentrations in 9VAC25-31-540 B 1, the pollutant concentrations in 9VAC25-31-540 B 3, the Class A pathogen requirements in 9VAC25-31-710 A, and one of the vector attraction reduction requirements in 9VAC25-31-720 B 1 through B 8.

9VAC25-31-530. General requirements.

A. No person shall apply ~~sewage sludge biosolids~~ to the land except in accordance with the requirements in this article.

B. No person shall apply bulk ~~sewage-sludge biosolids~~ subject to the cumulative pollutant loading rates in 9VAC25-31-540 B 2 to agricultural land, forest, a public contact site, or a reclamation site if any of the cumulative pollutant loading rates in 9VAC25-31-540 B 2 has been reached.

C. No person shall apply domestic septage to agricultural land, forest, or a reclamation site during a 365-day period if the annual application rate in 9VAC25-31-540 C has been reached during that period.

D. The person who prepares bulk ~~sewage-sludge biosolids~~ that is applied to agricultural land, forest, a public contact site, or a reclamation site shall provide the person who applies the bulk ~~sewage-sludge biosolids~~ written notification of the concentration of total nitrogen (as N on a dry weight basis) in the bulk ~~sewage-sludge biosolids~~.

E. Application of biosolids to the land.

~~E.~~ 1. The person who applies ~~sewage-sludge biosolids~~ to the land shall obtain information needed to comply with the requirements in this subpart.

2. ~~a.~~ Before bulk ~~sewage-sludge biosolids~~ subject to the cumulative pollutant loading rates in 9VAC25-31-540 B 2 is applied to the land;

~~the a.~~ The person who proposes to apply the bulk ~~sewage-sludge biosolids~~ shall contact the department to determine whether bulk ~~sewage-sludge biosolids~~ subject to the cumulative pollutant loading rates in 9VAC25-31-540 B 2 has been applied to the site since July 20, 1993.

b. If bulk ~~sewage-sludge biosolids~~ subject to the cumulative pollutant loading rates in 9VAC25-31-540 B 2 has not been applied to the site since July 20, 1993, the cumulative amount for each pollutant listed in Table 2 of 9VAC25-31-540 may be applied to the site in accordance with 9VAC25-31-540 A 2 a.

c. If bulk ~~sewage-sludge biosolids~~ subject to the cumulative pollutant loading rates in 9VAC25-31-540 B 2 has been applied to the site since July 20, 1993, and the cumulative amount of each pollutant applied to the site in the bulk ~~sewage-sludge biosolids~~ since that date is known, the cumulative amount of each pollutant applied to the site shall be used to determine the additional amount of each pollutant that can be applied to the site in accordance with 9VAC25-31-540 A 2 a.

d. If bulk ~~sewage-sludge biosolids~~ subject to the cumulative pollutant loading rates in 9VAC25-31-540 B 2 has been applied to the site since July 20, 1993, and the cumulative amount of each pollutant applied to the site in the bulk ~~sewage-sludge biosolids~~ since that date is not known, an additional amount of each pollutant shall not be applied to the site in accordance with 9VAC25-31-540 A 2 a.

F. When a person who prepares bulk ~~sewage-sludge biosolids~~ provides the bulk ~~sewage-sludge biosolids~~ to a person who applies the bulk ~~sewage-sludge biosolids~~ to the

land, the person who prepares the bulk ~~sewage-sludge biosolids~~ shall provide the person who applies the ~~sewage-sludge biosolids~~ notice and necessary information to comply with the requirements in this article.

G. When a person who prepares ~~sewage-sludge biosolids~~ provides the ~~sewage-sludge biosolids~~ to another person who prepares the ~~sewage-sludge biosolids~~, the person who provides the ~~sewage-sludge biosolids~~ shall provide the person who receives the ~~sewage-sludge biosolids~~ notice and necessary information to comply with the requirements in this article.

H. The person who applies bulk ~~sewage-sludge biosolids~~ to the land shall provide the owner or lease holder of the land on which the bulk ~~sewage-sludge biosolids~~ is applied notice and necessary information to comply with the requirements in this article.

I. Any person who prepares bulk ~~sewage-sludge biosolids~~ in another state that is applied to land in Virginia shall provide written notice to the department prior to the initial application of bulk ~~sewage-sludge biosolids~~ to the land application site by the applier. The notice shall include:

1. The location, by either street address or latitude and longitude, of each land application site;
2. The approximate time period bulk ~~sewage-sludge biosolids~~ will be applied to the site;
3. The name, address, telephone number, and National Pollutant Discharge Elimination System permit number (if appropriate) for the person who prepares the bulk ~~sewage-sludge biosolids~~; and
4. The name, address, telephone number, and National (or Virginia) Pollutant Discharge Elimination System permit number (if appropriate) for the person who will apply the bulk ~~sewage-sludge biosolids~~.

J. Any person who applies bulk ~~sewage-sludge biosolids~~ subject to the cumulative pollutant loading rates in 9VAC25-31-540 B 2 to the land shall provide written notice, prior to the initial application of bulk ~~sewage-sludge biosolids~~ to a land application site by the applier, to the department and the department shall retain and provide access to the notice. The notice shall include:

1. The location, by either street address or latitude and longitude, of the land application site; and
2. The name, address, telephone number, and Virginia Pollutant Discharge Elimination System permit number (if appropriate) of the person who will apply the bulk ~~sewage-sludge biosolids~~.

9VAC25-31-540. Pollutant limits.

A. Sewage-sludge Biosolids.

1. Bulk ~~sewage-sludge biosolids~~ or ~~sewage-sludge biosolids~~ sold or given away in a bag or other container shall not be applied to the land if the concentration of any

Regulations

pollutant in the ~~sewage sludge~~ biosolids exceeds the ceiling concentration for the pollutant in Table 1 of this section.

2. If bulk ~~sewage sludge~~ biosolids is applied to agricultural land, forest, a public contact site, or a reclamation site, either:

a. The cumulative loading rate for each pollutant shall not exceed the cumulative pollutant loading rate for the pollutant in Table 2 of this section; or

b. The concentration of each pollutant in the ~~sewage sludge~~ biosolids shall not exceed the concentration for the pollutant in Table 3 of ~~9VAC25-31-540~~ this section.

3. If bulk ~~sewage sludge~~ biosolids is applied to a lawn or a home garden, the concentration of each pollutant in the ~~sewage sludge~~ biosolids shall not exceed the concentration for the pollutant in Table 3 of this section.

4. If ~~sewage sludge~~ biosolids is sold or given away in a bag or other container for application to the land, either:

a. The concentration of each pollutant in the ~~sewage sludge~~ biosolids shall not exceed the concentration for the pollutant in Table 3 of this section; or

b. The product of the concentration of each pollutant in the ~~sewage sludge~~ biosolids and the annual whole sludge application rate for the ~~sewage sludge~~ biosolids shall not cause the annual pollutant loading rate for the pollutant in Table 4 of this section to be exceeded. The procedure used to determine the annual whole sludge application rate is presented in subsection D of this section.

B. Pollutant concentrations and loading rates - ~~sewage sludge~~ biosolids.

TABLE 1
CEILING CONCENTRATIONS

Pollutant	Ceiling Concentration (milligrams per kilogram)*
Arsenic	75
Cadmium	85
Copper	4300 <u>4,300</u>
Lead	840
Mercury	57
Molybdenum [⁽⁴⁾]	75
Nickel	420
Selenium	100
Zinc	7500 <u>7,500</u>

*Dry weight basis

[⁽⁴⁾ ~~Biosolids with a molybdenum concentration greater than 40 mg/kg shall not be applied to land used for livestock grazing.~~]

TABLE 2
CUMULATIVE POLLUTANT LOADING RATES⁽¹⁾

Pollutant	Cumulative Pollutant Loading Rate	
	Cumulative Pollutant Loading Rate (kilograms per hectare)	(pounds per acre)
Arsenic ⁽²⁾	41	<u>36</u>
Cadmium	39	<u>35</u>
Copper	1500 <u>1,500</u>	<u>1,340</u>
Lead	300	<u>270</u>
Mercury	17	<u>16</u>
<u>Molybdenum⁽²⁾</u>		
Nickel	420	<u>375</u>
Selenium	100	<u>89</u>
Zinc	2800 <u>2,800</u>	<u>2,500</u>

Notes:

⁽¹⁾Such total applications to be made on soils with the biosolids/soil mixture pH adjusted to 6.0 or greater if the biosolids cadmium content is greater than or equal to 21 mg/kg.

The maximum cumulative application rate is limited for all ranges of cation exchange capacity due to soil background pH in Virginia of less than 6.5 and lack of regulatory controls of soil pH adjustment after biosolids application ceases.

⁽²⁾The maximum cumulative application rate is currently under study by the USEPA. [Research suggests that for Molybdenum a cumulative pollutant loading rate below 40 kg/hectare may be appropriate to reduce the risk of copper deficiency in grazing animals.]

TABLE 3
POLLUTANT CONCENTRATIONS

Pollutant	Monthly Average Concentration (milligrams per kilogram)*
Arsenic	41
Cadmium	39
Copper	1500 <u>1,500</u>
Lead	300

Mercury	17
<u>Molybdenum</u> ⁽¹⁾	
Nickel	420
Selenium	100
Zinc	2800 <u>2,800</u>
*Dry weight basis	
<u>Note:</u> ⁽¹⁾ The monthly average concentration is currently under study by the USEPA. [Research suggests that a monthly average Molybdenum concentration below 40 mg/kg may be appropriate to reduce the risk of copper deficiency in grazing animals.]	

⁽²⁾The maximum cumulative application rate is currently under study by the USEPA.

C. Domestic septage. The annual application rate for domestic septage applied to agricultural land, forest, or a reclamation site shall not exceed the annual application rate calculated using equation (1).

$$AAR = \frac{N}{0.0026} \quad (1)$$

Where:

~~AAR=Annual application rate in gallons per acre per 365-day period.~~

~~N=Amount of nitrogen in pounds per acre per 365-day period needed by the crop or vegetation grown on the land.~~

TABLE 4
ANNUAL POLLUTANT LOADING RATES

Pollutant	Annual Pollutant Loading Rate ⁽¹⁾ (per 365-day period)	
	Annual Pollutant Loading Rate (kilograms per hectare per 365-day period) (kilograms per hectare)	(pounds per acre)
Arsenic	2.0	<u>1.8</u>
Cadmium	1.9	<u>1.7</u>
Copper	75	<u>67</u>
Lead	15	<u>13</u>
Mercury	0.85	<u>0.76</u>
<u>Molybdenum</u> ⁽²⁾		
Nickel	21	<u>19</u>
Selenium	5.0	<u>4.6</u>
Zinc	140	<u>125</u>
<u>Notes:</u> ⁽¹⁾ Such total applications to be made on soils with the biosolids/soils mixture pH adjusted to 6.0 or greater if the biosolids cadmium content is greater than or equal to 21 mg/kg. The maximum cumulative application rate is limited for all ranges of cation exchange capacity due to soil pH in Virginia of less than 6.5 and lack of regulatory controls of soil pH adjustment after biosolids application ceases.		

EQUATION (1)

$$AAR = N/0.0026$$

AAR = Annual application rate in gallons per acre per 365-day period.

N = Amount of nitrogen in pounds per acre per 365-day period needed by the crop or vegetation grown on the land.

D. Procedures to determine the annual whole sludge application rate for ~~sewage sludge biosolids~~, 9VAC25-31-540 A 4 b requires that the product of the concentration for each pollutant listed in Table 4 of this section in ~~sewage sludge biosolids~~ sold or given away in a bag or other container for application to the land and the AWSAR for the ~~sewage sludge biosolids~~ not cause the annual pollutant loading rate for the pollutant in Table 4 to be exceeded. This section contains the procedure used to determine the AWSAR for a ~~sewage sludge biosolids~~ that does not cause the annual pollutant loading rates in Table 4 of this section to be exceeded.

1. The relationship between the APLR for a pollutant and the AWSAR for a ~~sewage sludge biosolids~~ is shown in equation (1) (2).

$$APLR = C \times AWSAR \times 0.001 \quad (1)$$

Where:

~~APLR=Annual pollutant loading rate in kilograms per hectare per 365-day period.~~

~~C=Pollutant concentration in milligrams per kilogram of total solids (dry weight basis).~~

~~AWSAR=Annual whole sludge application rate in metric tons per hectare per 365-day period (dry weight basis).~~

~~0.001=A conversion factor.~~

Regulations

EQUATION (2)

$$APLR = C [X x] AWSAR [X x] 0.001$$

APLR = Annual pollutant loading rate in kilograms per hectare per 365-day period

C = Pollutant concentration in milligrams per kilogram of total solids (dry weight basis)

AWSAR = Annual whole sludge application rate in metric tons per hectare per 365-day period (dry weight basis)

0.001 = A conversion factor

2. To determine the AWSAR, equation (1) (2) is rearranged into equation (2) (3):

$$AWSAR = \frac{APLR}{C \times 0.001} \quad (2)$$

EQUATION (3)

$$AWSAR = APLR / (C [X x] 0.001)$$

AWSAR = Annual whole sludge application rate in metric tons per hectare per 365-day period (dry weight basis)

APLR = Annual pollutant loading rate in kilograms per hectare per 365-day period

C = Pollutant concentration in milligrams per kilogram of total solids (dry weight basis)

0.001 = A conversion factor

3. The procedure used to determine the AWSAR for a ~~sewage sludge~~ biosolids is presented below.

1- a. Analyze a sample of the ~~sewage sludge~~ biosolids to determine the concentration for each of the pollutants listed in Table 4 of this section in the ~~sewage sludge~~ biosolids.

2- b. Using the pollutant concentrations from Step 1 and the APLRs from Table 4 of this section, calculate an AWSAR for each pollutant using equation (2) (3) above.

3- c. The AWSAR for the ~~sewage sludge~~ biosolids is the lowest AWSAR calculated in Step 2.

9VAC25-31-543. Soils monitoring.

A. Soil shall be sampled and analyzed prior to biosolids application to determine site suitability and to provide background data. [No sample analysis used to determine application rates shall be more than three years old at the time of biosolids land application.] Soil shall be sampled and analyzed in accordance with Table 1 of this section. [~~Reduced monitoring may apply for typical agricultural utilization projects where biosolids are applied to farmland at or below agronomic rates or on an infrequent basis (Table 1 of this section).~~] Reduced monitoring may also apply to one-

time biosolids applications to forest or reclaimed lands. For background analysis, random composite soil samples from the zone of incorporation are required for infrequent applications and frequent applications at less than agronomic rates (total less than 15 dry tons per acre).

TABLE 1
SOIL TEST PARAMETERS FOR LAND APPLICATION SITES¹

Parameter	[Biosolids Application			Storage
	Infrequent ²	Frequent Below Agronomic Rates ³	Frequent at Agronomic Rates ³	Super-natant ⁴
Soil pH (Std. Units)	*	*	*	*
Nitrate nitrogen (ppm) ⁵			*	
Available phosphorus (ppm) ⁵	*	*	*	*
Extractable potassium (ppm)	*	*	*	*
Extractable sodium (mg/100g)	6	6	6	6*
Extractable calcium (mg/100g)			*	*
Extractable magnesium (mg/100g)	*		*	*
Zinc (ppm)	*	*	*	*
Manganese (ppm)	*	*	*	
Hydraulic conductivity (cm/sec)				*

¹Note: Unless otherwise stated, analyses shall be reported on a dry weight basis (*).

²See 9VAC25-32-560 B 3.

³Only used as a supplemental fertilizer for side dressing corn.

⁴Liquid biosolids derived from biosolids use facilities.

⁵Available P shall be analyzed using one of the following methods: Mehlich I, Mehlich III, or Bray.

⁶Extractable sodium shall be analyzed only where biosolids known to be high in sodium will be land applied.

Parameter
Soil pH (Std. Units)
Available phosphorus (ppm) ²

Extractable potassium (ppm)
Extractable sodium (mg/100g) ³
Extractable calcium (mg/100g)
Extractable magnesium (mg/100g)
Zinc (ppm)
Manganese (ppm)
¹ Note: Unless otherwise stated, analyses shall be reported on a dry weight basis.
² Available P shall be analyzed using one of the following methods: Mehlich I or Mehlich III.
³ Extractable sodium shall be analyzed only where biosolids known to be high in sodium will be land applied.]

B. The department reserves the right to require the permit holder to conduct additional soil monitoring including, but not limited to, additional parameters, based on site-specific history or conditions.

C. Samples shall be collected in accordance with § 10.1-104.2 of the Code of Virginia.

[9VAC25-31-545. Crop monitoring:

A. ~~Vegetation monitoring may be required by the board upon recommendation of the department once every three years on sites with frequent applications of biosolids applied at or greater than agronomic rates and when 400 pounds per acre or more of available phosphorus had been applied to the soil. Analyses of plant tissue should be conducted at the proper growth stage as recommended by the Virginia Department of Agriculture and Consumer Services, the Virginia Department of Conservation and Recreation, or the Virginia Cooperative Extension Service.~~

B. Routine analyses include:

1. Nitrate nitrogen;
2. Phosphorus;
3. Potassium;
4. Calcium;
5. Manganese;
6. Magnesium;
7. Iron;
8. Copper; and
9. Zinc.

C. Analysis for additional parameters may be necessary as determined on a case by case basis.

D. Results shall be reported annually to the department.]

9VAC25-31-547. [~~Ground—water~~ Groundwater] monitoring.

A. Monitoring wells may be required by the department for land treatment sites, sludge lagoons, biosolids land application sites, or biosolids storage facilities to monitor [~~ground-water~~ groundwater] quality.

B. If [~~ground-water~~ groundwater] monitoring is required, a [~~ground-water~~ groundwater] monitoring plan shall be submitted to the department for approval that includes at a minimum:

1. Geologic and hydrologic conditions at the site;
2. Monitoring well design, placement, and construction;
3. Sampling frequency;
4. Sampling procedures, including quality assurance and quality control; and
5. Collection of background samples.

9VAC25-31-550. Management practices.

A. All biosolids land application activities shall comply with the operational requirements of Part IX (9VAC25-32-303 et seq.) of 9VAC25-32 (Biosolids Program of the VPA Permit Regulation).

A. ~~B. Bulk sewage sludge biosolids shall not be applied to the land if it is likely to adversely affect a threatened or endangered species listed in 9VAC25-260-320 or § 4 of the Endangered Species Act (16 USC § 1533) or if the land application is likely to adversely affect its designated critical habitat.~~

B. ~~C. Bulk sewage sludge biosolids shall not be applied to agricultural land, forest, a public contact site, or a reclamation site that is flooded, frozen, or snow-covered so that the bulk sewage sludge biosolids enters a wetland or other surface waters except as provided in a VPDES permit or a permit issued pursuant to § 404 of the CWA.~~

C. ~~D. Bulk sewage sludge biosolids shall not be applied to agricultural land, forest, or a reclamation site that is 10 meters or less from surface waters, unless otherwise specified by the board.~~

D. ~~E. Bulk sewage sludge biosolids shall be applied to agricultural land, forest, a public contact site, or a reclamation site at a whole sludge application rate that is equal to or less than the agronomic rate for the bulk sewage sludge biosolids, unless, in the case of a reclamation site, otherwise specified by the board.~~

E. ~~F. Either a label shall be affixed to the bag or other container in which sewage sludge biosolids that is sold or given away for application to the land, or an information sheet shall be provided to the person who receives sewage sludge biosolids sold or given away in [~~an a bag or~~] other container for application to the land. The label or information sheet shall contain the following information:~~

1. The name and address of the person who prepared the sewage sludge biosolids that is sold or given away in a bag or other container for application to the land;
2. A statement that application of the sewage sludge biosolids to the land is prohibited except in accordance with the instructions on the label or information sheet; and
3. The annual whole sludge application rate for the sewage sludge biosolids that does not cause any of the annual

Regulations

pollutant loading rates in Table 4 of 9VAC25-31-540 to be exceeded.

9VAC25-31-560. Operational standards, pathogens, and vector attraction reduction.

A. Pathogens - ~~sewage sludge~~ biosolids.

1. The Class A pathogen requirements in 9VAC25-31-710 A or the Class B pathogen requirements and site restrictions in 9VAC25-31-720 B shall be met when bulk ~~sewage sludge~~ biosolids is applied to agricultural land, forest, a public contact site, or a reclamation site.

2. The Class A pathogen requirements in 9VAC25-31-710 A shall be met when bulk ~~sewage sludge~~ biosolids is applied to a lawn or a home garden.

3. The Class A pathogen requirements in 9VAC25-31-710 A shall be met when ~~sewage sludge~~ biosolids is sold or given away in a bag or other container for application to the land.

B. Pathogens - domestic septage. The requirements in [either] 9VAC25-31-710 C [1 or C 2] shall be met when domestic septage is applied to agricultural land, forest, or a reclamation site.

C. Vector attraction reduction - ~~sewage sludge~~ biosolids.

1. One of the vector attraction reduction requirements in 9VAC25-31-720 B 1 through B 10 shall be met when bulk ~~sewage sludge~~ biosolids is applied to agricultural land, forest, a public contact site, or a reclamation site.

2. One of the vector attraction reduction requirements in 9VAC25-31-720 B 1 through B 8 shall be met when bulk ~~sewage sludge~~ biosolids is applied to a lawn or a home garden.

3. One of the vector attraction reduction requirements in 9VAC25-31-720 B 1 through B 8 shall be met when ~~sewage sludge~~ biosolids is sold or given away in a bag or other container for application to the land.

D. Vector attraction reduction - domestic septage. The vector attraction reduction requirements in 9VAC25-31-720 B 9, B 10, or B 12 shall be met when domestic septage is applied to agricultural land, forest, or a reclamation site.

9VAC25-31-570. Frequency of monitoring.

A. ~~Sewage sludge~~ Biosolids.

1. The frequency of monitoring for the pollutants listed in Tables 1 through 4 of 9VAC25-31-540; the pathogen density requirements in 9VAC25-31-710 A and B 2 through B 4; and the vector attraction reduction requirements in 9VAC25-31-720 B 1 through B 4, B 7 and B 8 shall be the frequency in Table 1 of this section.

TABLE 1
FREQUENCY OF MONITORING--LAND APPLICATION

Amount of sewage sludge * biosolids* (metric tons per 365-day period)	Frequency
Greater than zero but less than 290	once per year
Equal to or greater than 290 but less than 1,500	once per quarter (four times a year)
Equal to or greater than 1,500 but less than 15,000	once per 60 days (six times per year)
Equal to or greater than 15,000	once per month (12 times per year)

*Either the amount of bulk ~~sewage sludge~~ biosolids applied to the land or the amount of ~~sewage sludge~~ biosolids prepared for sale or give-away in a bag or other container for application to the land (dry weight basis).

2. After the ~~sewage sludge~~ biosolids has been monitored for two years at the frequency in Table 1 of this section, the board may reduce the frequency of monitoring for pollutant concentrations and for the pathogen density requirements in 9VAC25-31-710 A 5 b and c.

B. Domestic septage. If either the pathogen requirements in 9VAC25-31-710 C 2 or the vector attraction reduction requirements in 9VAC25-31-720 B 12 are met when domestic septage is applied to agricultural land, forest, or a reclamation site, each container of domestic septage applied to the land shall be monitored for compliance with those requirements.

9VAC25-31-580. Recordkeeping.

A. ~~Sewage sludge~~ Biosolids.

1. The person who prepares the ~~sewage sludge~~ biosolids in 9VAC25-31-510 B 1 or E shall develop the following information and shall retain the information for five years:

- The concentration of each pollutant listed in Table 3 of 9VAC25-31-540 in the ~~sewage sludge~~ biosolids;
- The following certification statement:

"I certify, under penalty of law, that the information that will be used to determine compliance with the Class A pathogen requirements in 9VAC25-31-710 A and the vector attraction reduction requirement in (insert one of the vector attraction reduction requirements in 9VAC25-31-720 B 1 through B 8) was prepared under my direction and supervision in accordance with the system designed to ensure that qualified personnel properly gather and evaluate this information. I am aware that

there are significant penalties for false certification including the possibility of fine and imprisonment.";

c. A description of how the Class A pathogen requirements in 9VAC25-31-710 A are met; and

d. A description of how one of the vector attraction reduction requirements in 9VAC25-31-720 B 1 through B 8 is met.

2. The person who derives the material in 9VAC25-31-510 C 1 or in 9VAC25-31-510 F shall develop the following information and shall retain the information for five years:

a. The concentration of each pollutant listed in Table 3 of 9VAC25-31-540 in the material;

b. The following certification statement:

"I certify, under penalty of law, that the information that will be used to determine compliance with the Class A pathogen requirements in 9VAC25-31-710 A and the vector attraction reduction requirement in (insert one of the vector attraction reduction requirements in 9VAC25-31-720 B 1 through B 8) was prepared under my direction and supervision in accordance with the system designed to ensure that qualified personnel properly gather and evaluate this information. I am aware that there are significant penalties for false certification including the possibility of fine and imprisonment.";

c. A description of how the Class A pathogen requirements in 9VAC25-31-710 A are met; and

d. A description of how one of the vector attraction reduction requirements in 9VAC25-31-720 B 1 through B 8 is met.

3. If the pollutant concentrations in 9VAC25-31-540 B 3, the Class A pathogen requirements in 9VAC25-31-710 A, and the vector attraction reduction requirements in either 9VAC25-31-720 B 9 or B 10 are met when bulk ~~sewage sludge~~ biosolids is applied to agricultural land, forest, a public contact site, or a reclamation site:

a. The person who prepares the bulk ~~sewage sludge~~ biosolids shall develop the following information and shall retain the information for five years:

(1) The concentration of each pollutant listed in Table 3 of 9VAC25-31-540 in the bulk ~~sewage sludge~~ biosolids;

(2) The following certification statement:

"I certify, under penalty of law, that the information that will be used to determine compliance with the pathogen requirements in 9VAC25-31-710 A was prepared under my direction and supervision in accordance with the system designed to ensure that qualified personnel properly gather and evaluate this information. I am aware that there are significant penalties for false certification including the possibility of fine and imprisonment.";

(3) A description of how the pathogen requirements in 9VAC25-31-710 A are met.

b. The person who applies the bulk ~~sewage sludge~~ biosolids shall develop the following information and shall retain the information for five years:

(1) The following certification statement:

"I certify, under penalty of law, that the information that will be used to determine compliance with the management practices in 9VAC25-31-550 and the vector attraction reduction requirement in (insert either 9VAC25-31-720 B 9 or B 10) was prepared under my direction and supervision in accordance with the system designed to ensure that qualified personnel properly gather and evaluate this information. I am aware that there are significant penalties for false certification including fine and imprisonment.";

(2) A description of how the management practices in 9VAC25-31-550 are met for each site on which bulk ~~sewage sludge~~ biosolids is applied; and

(3) A description of how the vector attraction reduction requirements in either 9VAC25-31-720 B 9 or B 10 are met for each site on which bulk ~~sewage sludge~~ biosolids is applied.

4. If the pollutant concentrations in 9VAC25-31-540 B 3 and the Class B pathogen requirements in 9VAC25-31-710 B are met when bulk ~~sewage sludge~~ biosolids is applied to agricultural land, forest, a public contact site, or a reclamation site:

a. The person who prepares the bulk ~~sewage sludge~~ biosolids shall develop the following information and shall retain the information for five years:

(1) The concentration of each pollutant listed in Table 3 of 9VAC25-31-540 in the bulk ~~sewage sludge~~ biosolids;

(2) The following certification statement:

"I certify under, penalty of law, that the information that will be used to determine compliance with the Class B pathogen requirements in 9VAC25-31-710 B and the vector attraction reduction requirement in (insert one of the vector attraction reduction requirements in 9VAC25-31-720 B 1 through B 8, if one of those requirements is met) was prepared under my direction and supervision in accordance with the system designed to ensure that qualified personnel properly gather and evaluate this information. I am aware that there are significant penalties for false certification including the possibility of fine and imprisonment.";

(3) A description of how the Class B pathogen requirements in 9VAC25-31-710 B are met; and

(4) When one of the vector attraction reduction requirements in 9VAC25-31-720 B 1 through B 8 is met, a description of how the vector attraction reduction requirement is met.

Regulations

b. The person who applies the bulk ~~sewage sludge~~ biosolids shall develop the following information and shall retain the information for five years:

(1) The following certification statement:

"I certify, under penalty of law, that the information that will be used to determine compliance with the management practices in 9VAC25-31-550, the site restrictions in 9VAC25-31-710 B 5, and the vector attraction reduction requirements in (insert either 9VAC25-31-720 B 9 or B 10, if one of those requirements is met) was prepared for each site on which bulk ~~sewage sludge~~ biosolids is applied under my direction and supervision in accordance with the system designed to ensure that qualified personnel properly gather and evaluate this information. I am aware that there are significant penalties for false certification including the possibility of fine and imprisonment.";

(2) A description of how the management practices in 9VAC25-31-550 are met for each site on which bulk ~~sewage sludge~~ biosolids is applied;

(3) A description of how the site restrictions in 9VAC25-31-710 B 5 are met for each site on which bulk ~~sewage sludge~~ biosolids is applied;

(4) When the vector attraction reduction requirement in either 9VAC25-31-720 B 9 or B 10 is met, a description of how the vector attraction reduction requirement is met; and

(5) The date bulk ~~sewage sludge~~ biosolids is applied to each site.

5. If the requirements in 9VAC25-31-540 A 2 a are met when bulk ~~sewage sludge~~ biosolids is applied to agricultural land, forest, a public contact site, or a reclamation site:

a. The person who prepares the bulk ~~sewage sludge~~ biosolids shall develop the following information and shall retain the information for five years:

(1) The concentration of each pollutant listed in Table 1 of 9VAC25-31-540 in the bulk ~~sewage sludge~~ biosolids;

(2) The following certification statement:

"I certify, under penalty of law, that the information that will be used to determine compliance with the pathogen requirements in (insert either 9VAC25-31-710 A or B and the vector attraction reduction requirement in insert one of the vector attraction reduction requirements in 9VAC25-31-720 B 1 through B 8, if one of those requirements is met) was prepared under my direction and supervision in accordance with the system designed to ensure that qualified personnel properly gather and evaluate this information. I am aware that there are significant penalties for false certification including the possibility of fine and imprisonment.";

(3) A description of how the pathogen requirements in either 9VAC25-31-710 A or B are met; and

(4) When one of the vector attraction requirements in 9VAC25-31-720 B 1 through B 8 is met, a description of how the vector attraction requirement is met.

b. The person who applies the bulk ~~sewage sludge~~ biosolids shall develop the following information, retain the information in 9VAC25-31-580 A 5 b (1) through b (7) indefinitely, and retain the information in 9VAC25-31-580 A 5 b (8) through b (13) for five years:

(1) The location, by either street address or latitude and longitude, of each site on which bulk ~~sewage sludge~~ biosolids is applied;

(2) The number of hectares in each site on which bulk ~~sewage sludge~~ biosolids is applied;

(3) The date bulk ~~sewage sludge~~ biosolids is applied to each site;

(4) The cumulative amount of each pollutant (i.e., kilograms) listed in Table 2 of 9VAC25-31-540 in the bulk ~~sewage sludge~~ biosolids applied to each site, including the amount in 9VAC25-31-530 E 2 c;

(5) The amount of ~~sewage sludge~~ biosolids (i.e., metric tons) applied to each site;

(6) The following certification statement:

"I certify, under penalty of law, that the information that will be used to determine compliance with the requirements to obtain information in 9VAC25-31-530 E 2 was prepared for each site on which bulk ~~sewage sludge~~ biosolids is applied under my direction and supervision in accordance with the system designed to ensure that qualified personnel properly gather and evaluate this information. I am aware that there are significant penalties for false certification including fine and imprisonment.";

(7) A description of how the requirements to obtain information in 9VAC25-31-530 E 2 are met;

(8) The following certification statement:

"I certify, under penalty of law, that the information that will be used to determine compliance with the management practices in 9VAC25-31-550 was prepared for each site on which bulk ~~sewage sludge~~ biosolids is applied under my direction and supervision in accordance with the system designed to ensure that qualified personnel properly gather and evaluate this information. I am aware that there are significant penalties for false certification including fine and imprisonment.";

(9) A description of how the management practices in 9VAC25-31-550 are met for each site on which bulk ~~sewage sludge~~ biosolids is applied;

(10) The following certification statement when the bulk ~~sewage sludge~~ biosolids meets the Class B pathogen requirements in 9VAC25-31-710 B:

"I certify, under penalty of law, that the information that will be used to determine compliance with the site restrictions in 9VAC25-31-710 B 5 was prepared under my direction and supervision in accordance with the system designed to ensure that qualified personnel properly gather and evaluate this information. I am aware that there are significant penalties for false certification including fine and imprisonment.";

(11) A description of how the site restrictions in 9VAC25-31-710 B 5 are met for each site on which Class B bulk ~~sewage sludge~~ biosolids is applied;

(12) The following certification statement when the vector attraction reduction requirement in either 9VAC25-31-720 B 9 or B 10 is met:

"I certify, under penalty of law, that the information that will be used to determine compliance with the vector attraction reduction requirement in (insert either 9VAC25-31-720 B 9 or B 10) was prepared under my direction and supervision in accordance with the system designed to ensure that qualified personnel properly gather and evaluate this information. I am aware that there are significant penalties for false certification including the possibility of fine and imprisonment."; and

(13) If the vector attraction reduction requirements in either 9VAC25-31-720 B 9 or B 10 are met, a description of how the requirements are met.

6. If the requirements in 9VAC25-31-540 A 4 b are met when ~~sewage sludge~~ biosolids is sold or given away in a bag or other container for application to the land, the person who prepares the ~~sewage sludge~~ biosolids that is sold or given away in a bag or other container shall develop the following information and shall retain the information for five years:

a. The annual whole sludge application rate for the ~~sewage sludge~~ biosolids that does not cause the annual pollutant loading rates in Table 4 of 9VAC25-31-540 to be exceeded;

b. The concentration of each pollutant listed in Table 4 of 9VAC25-31-540 in the ~~sewage sludge~~ biosolids;

c. The following certification statement:

"I certify, under penalty of law, that the information that will be used to determine compliance with the management practice in 9VAC25-31-550 E, the Class A pathogen requirement in 9VAC25-31-710 A, and the vector attraction reduction requirement in (insert one of the vector attraction reduction requirements in 9VAC25-31-720 B 1 through B 8) was prepared under my direction and supervision in accordance with the system designed to ensure that qualified personnel properly gather and evaluate this information. I am aware that

there are significant penalties for false certification including the possibility of fine and imprisonment.";

d. A description of how the Class A pathogen requirements in 9VAC25-31-710 A are met; and

e. A description of how one of the vector attraction requirements in 9VAC25-31-720 B 1 through B 8 is met.

B. Domestic septage. When domestic septage is applied to agricultural land, forest, or a reclamation site, the person who applies the domestic septage shall develop the following information and shall retain the information for five years:

1. The location, by either street address or latitude and longitude, of each site on which domestic septage is applied;

2. The number of acres in each site on which domestic septage is applied;

3. The date domestic septage is applied to each site;

4. The nitrogen [and phosphorus] requirement for the crop or vegetation grown on each site during a 365-day period;

5. The rate, in gallons per acre per 365-day period, at which domestic septage is applied to each site;

6. The following certification statement:

"I certify, under penalty of law, that the information that will be used to determine compliance with the pathogen requirements in (insert either 9VAC25-31-710 C 1 or 2) and the vector attraction reduction requirements in (insert 9VAC25-31-720 B 9, 10, or 12) was prepared under my direction and supervision in accordance with the system designed to ensure that qualified personnel properly gather and evaluate this information. I am aware that there are significant penalties for false certification including the possibility of fine and imprisonment.";

7. A description of how the pathogen requirements in either 9VAC25-31-710 C 1 or 2 are met; and

8. A description of how the vector attraction reduction requirements in 9VAC25-31-720 B 9, 10, or 12 are met.

9VAC25-31-590. Reporting.

A. Class I sludge management facilities, POTWs with a design flow rate equal to or greater than one million gallons per day, and POTWs that serve 10,000 people or more shall submit the following information to the department:

1. The information in 9VAC25-31-580 A, except the information in 9VAC25-31-580 A 3 b, 4 b and 5 b, for the appropriate requirements on February 19 of each year for the previous calendar year's activity; and

2. The information in 9VAC25-31-580 A 5 b (1) through (7) on February 19 of each year for the previous calendar year's activity when 90% or more of any of the cumulative pollutant loading rates in Table 2 of 9VAC25-31-540 is reached at a land application site.

Regulations

B. An activity report shall be submitted (electronically or postmarked) to the department by the 15th of [~~the~~ each] month [for land application activity that occurred in the previous calendar month,] unless another date is specified in the permit in accordance with 9VAC25-32-80 I 4 [~~; following any month in which land application occurs] . The report shall indicate those sites where land application activities took place during the previous month. [If no land application occurs under a permit during the calendar month, a report shall be submitted stating that no land application occurred.]~~

C. [~~Biosolids application rates shall be calculated using results from sampling and analysis completed during the most recent 12 months of monitoring. For proposed treatment works, rates may be initially based on the biosolids characteristic produced by similar generating facilities.~~

D.] Records shall be maintained documenting the required treatment and quality characteristics and the maximum allowable land application loading rates established for biosolids use. In addition, operational monitoring results shall verify that required sludge treatment has achieved the specified levels of pathogen control and vector attraction reductions (9VAC25-31-710 and 9VAC25-31-720). Adequate records of biosolids composition, treatment classification, and biosolids application rates and methods of application for each site shall be maintained by the generator and owner.

[~~E. D.] The generator and owner shall maintain the records for a minimum period of five years. Sites receiving frequent applications of biosolids that meet or exceed maximum cumulative constituent loadings and dedicated disposal sites should be properly referenced for future land transactions (Sludge Disposal Site Dedication Form).~~

Article 4

Pathogens and Vector Attraction Reduction

9VAC25-31-690. Scope.

A. This article contains the requirements for ~~a sewage sludge biosolids~~ to be classified either Class A or Class B with respect to pathogens.

B. This article contains the site restrictions for land on which a Class B ~~sewage sludge biosolids~~ is applied.

C. This article contains the pathogen requirements for domestic septage applied to agricultural land, forest, or a reclamation site.

D. This article contains alternative vector attraction reduction requirements for ~~sewage sludge biosolids~~ that is applied to the land or sewage sludge that is placed on a surface disposal site.

9VAC25-31-710. Pathogens.

A. ~~Sewage sludge Biosolids~~ - Class A.

1. The requirement in subdivision 2 of this subsection and the requirements in either subdivisions 3, 4, 5, 6, 7, or 8 of

this subsection shall be met for a ~~sewage sludge biosolids~~ to be classified Class A with respect to pathogens.

2. The Class A pathogen requirements in subdivisions 3 through 8 of this subsection shall be met either prior to meeting or at the same time the vector attraction reduction requirements in 9VAC25-31-720, except the vector attraction reduction requirements in 9VAC25-31-720 B 6 through B 8, are met.

3. Class A - Alternative 1.

a. Either the density of fecal coliform in the ~~sewage sludge biosolids~~ shall be less than 1,000 Most Probable Number per gram of total solids (dry weight basis), or the density of Salmonella sp. bacteria in the ~~sewage sludge biosolids~~ shall be less than three Most Probable Number per four grams of total solids (dry weight basis) at the time the ~~sewage sludge biosolids~~ is used [or disposed]; at the time the ~~sewage sludge biosolids~~ is prepared for sale or give away in a bag or other container for application to the land; or at the time the ~~sewage sludge biosolids~~ or material derived from ~~sewage sludge biosolids~~ is prepared to meet the requirements in 9VAC25-31-510 B, C, E, or F.

b. The temperature of the sewage sludge that is used or disposed shall be maintained at a specific value for a period of time.

(1) When the percent solids of the sewage sludge is 7.0% or higher, the temperature of the sewage sludge shall be 50°C or higher; the time period shall be 20 minutes or longer; and the temperature and time period shall be determined using ~~equation (3)~~ equation (1), except when small particles of sewage sludge are heated by either warmed gases or an immiscible liquid.

$$D = \frac{131,700,000}{10^{0.1400t}} \quad (3)$$

Where,

D = time in days.

t = temperature in degrees Celsius.

EQUATION (1)
$D = 131,700,000/10^{0.1400t}$
D = time in days
t = temperature in degrees Celsius

(2) When the percent solids of the sewage sludge is 7.0% or higher and small particles of sewage sludge are heated by either warmed gases or an immiscible liquid, the temperature of the sewage sludge shall be 50°C or higher; the time period shall be 15 seconds or longer; and the temperature and time period shall be determined using ~~equation (3)~~ equation (1).

(3) When the percent solids of the sewage sludge is less than 7.0% and the time period is at least 15 seconds, but less than 30 minutes, the temperature and time period shall be determined using ~~equation (3)~~ equation (1).

(4) When the percent solids of the sewage sludge is less than 7.0%; the temperature of the sewage sludge is 50°C or higher; and the time period is 30 minutes or longer, the temperature and time period shall be determined using ~~equation (4)~~ equation (2).

$$D = \frac{50,070,000}{10^{0.1400t}} \quad (4)$$

Where,

D = time in days.

t = temperature in degrees Celsius.

EQUATION (2)
$D = 50,070,000/10^{0.1400t}$
D = time in days
t = temperature in degrees Celsius

4. Class A - Alternative 2.

a. Either the density of fecal coliform in the ~~sewage sludge biosolids~~ shall be less than 1,000 Most Probable Number per gram of total solids (dry weight basis), or the density of Salmonella sp. bacteria in the ~~sewage sludge biosolids~~ shall be less than three Most Probable Number per four grams of total solids (dry weight basis) at the time the ~~sewage sludge biosolids~~ is used [or disposed]; at the time the ~~sewage sludge biosolids~~ is prepared for sale or give away in a bag or other container for application to the land; or at the time the ~~sewage sludge biosolids~~ or material derived from ~~sewage sludge biosolids~~ is prepared to meet the requirements in 9VAC25-31-510 B, C, E, or F.

b. (1) The pH of the sewage sludge that is used or disposed shall be raised to above 12 and shall remain above 12 for 72 hours.

(2) The temperature of the sewage sludge shall be above 52°C for 12 hours or longer during the period that the pH of the sewage sludge is above 12.

(3) At the end of the 72-hour period during which the pH of the sewage sludge is above 12, the sewage sludge shall be air dried to achieve a percent solids in the sewage sludge greater than 50%.

5. Class A - Alternative 3.

a. Either the density of fecal coliform in the ~~sewage sludge biosolids~~ shall be less than 1,000 Most Probable Number per gram of total solids (dry weight basis), or the density of Salmonella sp. bacteria in ~~sewage sludge biosolids~~ shall be less than three Most Probable Number

per four grams of total solids (dry weight basis) at the time the ~~sewage sludge biosolids~~ is used [or disposed]; at the time the ~~sewage sludge biosolids~~ is prepared for sale or give away in a bag or other container for application to the land; or at the time the ~~sewage sludge biosolids~~ or material derived from ~~sewage sludge biosolids~~ is prepared to meet the requirements in 9VAC25-31-510 B, C, E, or F.

b. (1) The sewage sludge shall be analyzed prior to pathogen treatment to determine whether the sewage sludge contains enteric viruses.

(2) When the density of enteric viruses in the sewage sludge prior to pathogen treatment is less than one Plaque-forming Unit per four grams of total solids (dry weight basis), the sewage sludge is Class A with respect to enteric viruses until the next monitoring episode for the sewage sludge.

(3) When the density of enteric viruses in the sewage sludge prior to pathogen treatment is equal to or greater than one Plaque-forming Unit per four grams of total solids (dry weight basis), the sewage sludge is Class A with respect to enteric viruses when the density of enteric viruses in the sewage sludge after pathogen treatment is less than one Plaque-forming Unit per four grams of total solids (dry weight basis) and when the values or ranges of values for the operating parameters for the pathogen treatment process that produces the [sewage sludge biosolids] that meets the enteric virus density requirement are documented.

(4) After the enteric virus reduction in subdivision 5 b (3) of this subsection is demonstrated for the pathogen treatment process, the [sewage sludge biosolids] continues to be Class A with respect to enteric viruses when the values for the pathogen treatment process operating parameters are consistent with the values or ranges of values documented in subdivision 5 b (3) of this subsection.

c. (1) The sewage sludge shall be analyzed prior to pathogen treatment to determine whether the sewage sludge contains viable helminth ova.

(2) When the density of viable helminth ova in the sewage sludge prior to pathogen treatment is less than one per four grams of total solids (dry weight basis), the sewage sludge is Class A with respect to viable helminth ova until the next monitoring episode for the sewage sludge.

(3) When the density of viable helminth ova in the sewage sludge prior to pathogen treatment is equal to or greater than one per four grams of total solids (dry weight basis), the sewage sludge is Class A with respect to viable helminth ova when the density of viable helminth ova in the sewage sludge after pathogen treatment is less than one per four grams of total solids (dry weight basis) and when the values or ranges of

Regulations

values for the operating parameters for the pathogen treatment process that produces the sewage sludge that meets the viable helminth ova density requirement are documented.

(4) After the viable helminth ova reduction in subdivision 5 c (3) of this subsection is demonstrated for the pathogen treatment process, the sewage sludge continues to be Class A with respect to viable helminth ova when the values for the pathogen treatment process operating parameters are consistent with the values or ranges of values documented in subdivision 5 c (3) of this subsection.

6. Class A - Alternative 4.

a. Either the density of fecal coliform in the ~~sewage sludge biosolids~~ shall be less than 1,000 Most Probable Number per gram of total solids (dry weight basis), or the density of Salmonella sp. bacteria in the ~~sewage sludge biosolids~~ shall be less than three Most Probable Number per four grams of total solids (dry weight basis) at the time the ~~sewage sludge biosolids~~ is used [or disposed]; at the time the ~~sewage sludge biosolids~~ is prepared for sale or give away in a bag or other container for application to the land; or at the time the ~~sewage sludge biosolids~~ or material derived from ~~sewage sludge biosolids~~ is prepared to meet the requirements in 9VAC25-31-510 B, C, E, or F.

b. The density of enteric viruses in the ~~sewage sludge biosolids~~ shall be less than one Plaque-forming Unit per four grams of total solids (dry weight basis) at the time the ~~sewage sludge biosolids~~ is used [or disposed]; at the time the ~~sewage sludge biosolids~~ is prepared for sale or give away in a bag or other container for application to the land; or at the time the ~~sewage sludge biosolids~~ or material derived from ~~sewage sludge biosolids~~ is prepared to meet the requirements in 9VAC25-31-510 B, C, E, or F, unless otherwise specified by the board.

c. The density of viable helminth ova in the ~~sewage sludge biosolids~~ shall be less than one per four grams of total solids (dry weight basis) at the time the ~~sewage sludge biosolids~~ is used [or disposed]; at the time the ~~sewage sludge biosolids~~ is prepared for sale or give away in a bag or other container for application to the land; or at the time the ~~sewage sludge biosolids~~ or material derived from ~~sewage sludge biosolids~~ is prepared to meet the requirements in 9VAC25-31-510 B, C, E, or F unless otherwise specified by the board.

7. Class A - Alternative 5.

a. Either the density of fecal coliform in the ~~sewage sludge biosolids~~ shall be less than 1,000 Most Probable Number per gram of total solids (dry weight basis), or the density of Salmonella, sp. bacteria in the ~~sewage sludge biosolids~~ shall be less than three Most Probable Number per four grams of total solids (dry weight basis) at the time the ~~sewage sludge biosolids~~ is used [or disposed];

at the time the ~~sewage sludge biosolids~~ is prepared for sale or give away in a bag or other container for application to the land; or at the time the ~~sewage sludge biosolids~~ or material derived from ~~sewage sludge biosolids~~ is prepared to meet the requirements in 9VAC25-31-510 B, C, E, or F.

b. ~~Sewage sludge Biosolids~~ that is used or disposed shall be treated in one of the processes to further reduce pathogens described in ~~9VAC25-31-710 E subsection E~~ of this section.

8. Class A - Alternative 6.

a. Either the density of fecal coliform in the ~~sewage sludge biosolids~~ shall be less than 1,000 Most Probable Number per gram of total solids (dry weight basis), or the density of Salmonella, sp. bacteria in the ~~sewage sludge biosolids~~ shall be less than three Most Probable Number per four grams of total solids (dry weight basis) at the time the ~~sewage sludge biosolids~~ is used [or disposed]; at the time the ~~sewage sludge biosolids~~ is prepared for sale or give away in a bag or other container for application to the land; or at the time the ~~sewage sludge biosolids~~ or material derived from ~~sewage sludge biosolids~~ is prepared to meet the requirements in 9VAC25-31-510 B, C, E, or F.

b. ~~Sewage sludge Biosolids~~ that is used or disposed shall be treated in a process that is equivalent to a process to further reduce pathogens, as determined by the board.

B. ~~Sewage sludge Biosolids~~ - Class B.

1. ~~a.~~ The requirements in either ~~9VAC25-31-710 B-2, B-3, or B-4~~ subdivision 3, 4, or 5 of this subsection shall be met for a ~~sewage sludge biosolids~~ to be classified Class B with respect to pathogens.

~~b.~~ 2. The site restrictions in ~~9VAC25-31-710 B-5~~ subdivision 6 of this subsection shall be met when ~~sewage sludge biosolids~~ that meets the Class B pathogen requirements in ~~9VAC25-31-710 B-2, B-3, or B-4~~ subdivision 3, 4, or 5 of this subsection is applied to the land.

~~2.~~ 3. Class B - Alternative 1.

a. Seven representative samples of the ~~sewage sludge biosolids~~ that is used or disposed shall be collected.

b. The geometric mean of the density of fecal coliform in the samples collected in subdivision ~~2~~ 3 a of this subsection shall be less than either 2,000,000 Most Probable Number per gram of total solids (dry weight basis) or 2,000,000 Colony Forming Units per gram of total solids (dry weight basis).

~~3.~~ 4. Class B - Alternative 2. ~~Sewage sludge Biosolids~~ that is used or disposed shall be treated in one of the processes to significantly reduce pathogens described in ~~9VAC25-31-710 D~~ subsection D of this section.

4. ~~5.~~ Class B - Alternative 3. ~~Sewage sludge~~ Biosolids that is used or disposed shall be treated in a process that is equivalent to a process to significantly reduce pathogens, as determined by the board.

~~5.~~ 6. Site restrictions.

a. Food crops with harvested parts that touch the ~~sewage sludge/soil mixture~~ biosolids/soil mixture and are totally above the land surface shall not be harvested for 14 months after application of ~~sewage sludge~~ biosolids.

b. Food crops with harvested parts below the surface of the land shall not be harvested for 20 months after application of ~~sewage sludge~~ biosolids when the ~~sewage sludge~~ biosolids remains on the land surface for four months or longer prior to incorporation into the soil.

c. Food crops with harvested parts below the surface of the land shall not be harvested for 38 months after application of ~~sewage sludge~~ biosolids when the ~~sewage sludge~~ biosolids remains on the land surface for less than four months prior to incorporation into the soil.

d. Food crops, feed crops, and fiber crops shall not be harvested for 30 days after application of ~~sewage sludge~~ biosolids.

e. Animals shall not be grazed on the land for 30 days after application of ~~sewage sludge~~ biosolids.

f. Turf grown on land where ~~sewage sludge~~ biosolids is applied shall not be harvested for one year after application of the ~~sewage sludge~~ biosolids when the harvested turf is placed on either land with a high potential for public exposure or a lawn, unless otherwise specified by the board.

g. Public access to land with a high potential for public exposure shall be restricted for one year after application of ~~sewage sludge~~ biosolids.

h. Public access to land with a low potential for public exposure shall be restricted for 30 days after application of ~~sewage sludge~~ biosolids.

C. Domestic septage [~~1.~~] The site restrictions in subdivision B ~~5~~ 6 of this section shall be met when domestic septage is applied to agricultural land, forest, or a reclamation site [~~3.~~]

[~~2. The pH of domestic septage applied to agricultural land, forest, or a reclamation site shall be raised to 12 or higher by alkaline addition and, without the addition of more alkaline material, shall remain at 12 or higher for 30 minutes and the site restrictions in subdivisions B ~~5~~ 6 a through B ~~5~~ 6 d of this section shall be met.]~~

D. Processes to significantly reduce pathogens (PSRP).

1. Aerobic digestion. Sewage sludge is agitated with air or oxygen to maintain aerobic conditions for a specific mean cell residence time at a specific temperature. Values for the mean cell residence time and temperature shall be between 40 days at 20°C and 60 days at 15°C.

2. Air drying. Sewage sludge is dried on sand beds or on paved or unpaved basins. The sewage sludge dries for a minimum of three months. During two of the three months, the ambient average daily temperature is above 0°C.

3. Anaerobic digestion. Sewage sludge is treated in the absence of air for a specific mean cell residence time at a specific temperature. Values for the mean cell residence time and temperature shall be between 15 days at 35°C to 55°C and 60 days at 20°C.

4. Composting. Using either the within-vessel, static aerated pile, or windrow composting methods, the temperature of the sewage sludge is raised to 40°C or higher and remains at 40°C or higher for five days. For four hours during the five days, the temperature in the compost pile exceeds 55°C.

5. Lime stabilization. Sufficient lime is added to the sewage sludge to raise the pH of the sewage sludge to 12 after two hours of contact.

E. Processes to further reduce pathogens (PFRP).

1. Composting. Using either the within-vessel composting method or the static aerated pile composting method, the temperature of the sewage sludge is maintained at 55°C or higher for three days. Using the windrow composting method, the temperature of the sewage sludge is maintained at 55°C or higher for 15 days or longer. During the period when the compost is maintained at 55°C or higher, there shall be a minimum of five turnings of the windrow.

2. Heat drying. Sewage sludge is dried by direct or indirect contact with hot gases to reduce the moisture content of the sewage sludge to 10.0% or lower. Either the temperature of the sewage sludge particles exceeds 80°C or the wet bulb temperature of the gas in contact with the sewage sludge as the sewage sludge leaves the dryer exceeds 80°C.

3. Heat treatment. Liquid sewage sludge is heated to a temperature of 180°C or higher for 30 minutes.

4. Thermophilic aerobic digestion. Liquid sewage sludge is agitated with air or oxygen to maintain aerobic conditions and the mean cell residence time of the sewage sludge is 10 days at 55°C to 60°C.

5. Beta ray irradiation. Sewage sludge is irradiated with beta rays from an accelerator at dosages of at least 1.0 megarad at room temperature (ca. 20°C).

6. Gamma ray irradiation. Sewage sludge is irradiated with gamma rays from certain isotopes, such as Cobalt 60 and Cesium 137, at dosages of at least 1.0 megarad at room temperature (ca. 20°C).

7. Pasteurization. The temperature of the sewage sludge is maintained at 70°C or higher for 30 minutes or longer.

9VAC25-31-720. Vector attraction reduction.

A. Vector attraction reduction requirements:

Regulations

~~A-~~ 1. One of the vector attraction reduction requirements in subdivisions B 1 through B 10 of this section shall be met when bulk ~~sewage sludge~~ biosolids is applied to agricultural land, forest, a public contact site, or a reclamation site.

2. One of the vector attraction reduction requirements in subdivisions B 1 through B 8 of this section shall be met when bulk ~~sewage sludge~~ biosolids is applied to a lawn or a home garden.

3. One of the vector attraction reduction requirements in subdivisions B 1 through B 8 of this section shall be met when ~~sewage sludge~~ biosolids is sold or given away in a bag or other container for application to the land.

4. One of the vector attraction reduction requirements in subdivisions B 1 through B 11 of this section shall be met when sewage sludge (other than domestic septage) is placed on an active sewage sludge unit.

5. One of the vector attraction reduction requirements in subdivision B 9, B 10, or B 12 of this section shall be met when domestic septage is applied to agricultural land, forest, or a reclamation site and one of the vector attraction reduction requirements in subdivisions B 9 through B 12 of this section shall be met when domestic septage is placed on an active sewage sludge unit.

B. Vector attraction reduction options:

~~B-~~ 1. The mass of volatile solids in the sewage sludge shall be reduced by a minimum of 38%, calculated according to the method in 9VAC25-31-490 B 8.

2. When the 38% volatile solids reduction requirement in subdivision 1 of this subsection cannot be met for an anaerobically digested sewage sludge, vector attraction reduction can be demonstrated by digesting a portion of the previously digested sewage sludge anaerobically in the laboratory in a bench-scale unit for 40 additional days at a temperature between 30°C and 37°C. When at the end of the 40 days, the volatile solids in the sewage sludge at the beginning of that period is reduced by less than 17%, vector attraction reduction is achieved.

3. When the 38% volatile solids reduction requirement in subdivision 1 of this section cannot be met for an aerobically digested sewage sludge, vector attraction reduction can be demonstrated by digesting a portion of the previously digested sewage sludge that has a percent solids of 2.0% or less aerobically in the laboratory in a bench-scale unit for 30 additional days at 20°C. When at the end of the 30 days, the volatile solids in the sewage sludge at the beginning of that period is reduced by less than 15%, vector attraction reduction is achieved.

4. The specific oxygen uptake rate (SOUR) for sewage sludge treated in an aerobic process shall be equal to or less than 1.5 milligrams of oxygen per hour per gram of total solids (dry weight basis) at a temperature of 20°C.

5. Sewage sludge shall be treated in an aerobic process for 14 days or longer. During that time, the temperature of the sewage sludge shall be higher than 40°C and the average temperature of the sewage sludge shall be higher than 45°C.

6. The pH of sewage sludge shall be raised to 12 or higher by alkaline addition and, without the addition of more alkaline material, shall remain at 12 or higher for two hours and then at 11.5 or higher for an additional 22 hours.

7. The percent solids of sewage sludge that does not contain unstabilized solids generated in a primary wastewater treatment process shall be equal to or greater than 75% based on the moisture content and total solids prior to mixing with other materials.

8. The percent solids of sewage sludge that contains unstabilized solids generated in a primary wastewater treatment process shall be equal to or greater than 90% based on the moisture content and total solids prior to mixing with other materials.

9. Sewage sludge injection requirements:

~~9-~~ a. Sewage sludge shall be injected below the surface of the land.

b. No significant amount of the sewage sludge shall be present on the land surface within one hour after the sewage sludge is injected.

c. When the sewage sludge that is injected below the surface of the land is Class A with respect to pathogens, the sewage sludge shall be injected below the land surface within eight hours after being discharged from the pathogen treatment process.

10. Sewage sludge incorporation requirements:

~~10-~~ a. Sewage sludge applied to the land surface or placed on an active sewage sludge unit shall be incorporated into the soil within six hours after application to or placement on the land, unless otherwise specified by the board.

b. When sewage sludge that is incorporated into the soil is Class A with respect to pathogens, the sewage sludge shall be applied to or placed on the land within eight hours after being discharged from the pathogen treatment process.

11. Sewage sludge placed on an active sewage sludge unit shall be covered with soil or other material at the end of each operating day.

12. The pH of domestic septage shall be raised to 12 or higher by alkaline addition and, without the addition of more alkaline material, shall remain at 12 or higher for 30 minutes.

[~~DOCUMENTS INCORPORATED BY REFERENCE~~
(9VAC25-31)

~~Method 1668B Chlorinated Biphenyl Congeners in Water, Soil, Sediment, Biosolids, and Tissue by HRGC/HRMS,~~

EPA 821 R-08-020, November 2008, U.S. Environmental Protection Agency, Office of Water and Office of Science and Technology Engineering and Analysis Division (4303T), 1200 Pennsylvania Avenue, NW, Washington, DC 20460.]

Part I
General

9VAC25-32-10. Definitions.

A. The following words and terms, when used in this chapter and in VPA permits issued under this chapter shall have the meanings defined in the State Water Control Law, unless the context clearly indicates otherwise and as follows:

"Active sewage sludge unit" means a sewage sludge unit that has not closed.

"Aerobic digestion" means the biochemical decomposition of organic matter in sewage sludge into carbon dioxide and water by microorganisms in the presence of air.

"Agricultural land" means land on which a food crop, a feed crop, or a fiber crop is grown. This includes range land and land used as pasture.

"Agronomic rate" means [, in regard to biosolids,] the whole sludge application rate (dry weight basis) designed: (i) to provide the amount of nitrogen needed by the food crop, feed crop, fiber crop, cover crop, or vegetation grown on the land and (ii) to minimize the amount of nitrogen in the biosolids that passes below the root zone of the crop or vegetation grown on the land to the [~~ground-water~~ groundwater].

"Anaerobic digestion" means the biochemical decomposition of organic matter in sewage sludge or biosolids into methane gas and carbon dioxide by microorganisms in the absence of air.

"Annual pollutant loading rate" or "APLR" means the maximum amount of a pollutant that can be applied to a unit area of land during a 365-day period.

"Annual whole sludge application rate" or "AWSAR" means the maximum amount of biosolids (dry weight basis) that can be applied to a unit area of land during a 365-day period.

"Apply biosolids" or "biosolids applied to the land" means land application of biosolids.

"Best Management Practices (BMP)" means a schedule of activities, prohibition of practices, maintenance procedures and other management practices to prevent or reduce the pollution of state waters. BMP's include treatment requirements, operating and maintenance procedures, schedule of activities, prohibition of activities, and other management practices to control plant site runoff, spillage, leaks, sludge or waste disposal, or drainage from raw material storage.

"Biosolids" means a sewage sludge that has received an established treatment and is managed in a manner to meet the required pathogen control and vector attraction reduction, and contains concentrations of regulated pollutants below the

ceiling limits established in 40 CFR Part 503 and 9VAC25-32-660, such that it meets the standards established for use of biosolids for land application, marketing, or distribution in accordance with this regulation. [Liquid biosolids contains less than 15% dry residue by weight. Dewatered biosolids contains 15% or more dry residue by weight.]

"Board" means the Virginia State Water Control Board or State Water Control Board.

"Bulk biosolids" means biosolids that are not sold or given away in a bag or other container for application to the land.

"Bypass" means intentional diversion of waste streams from any portion of a treatment works.

"Concentrated confined animal feeding operation" means an animal feeding operation at which:

1. At least the following number and types of animals are confined:
 - a. 300 slaughter and feeder cattle;
 - b. 200 mature dairy cattle (whether milked or dry cows);
 - c. 750 swine each weighing over 25 kilograms (approximately 55 pounds);
 - d. 150 horses;
 - e. 3,000 sheep or lambs;
 - f. 16,500 turkeys;
 - g. 30,000 laying hens or broilers; or
 - h. 300 animal units; and

2. Treatment works are required to store wastewater, or otherwise prevent a point source discharge of wastewater pollutants to state waters from the animal feeding operation except in the case of a storm event greater than the 25-year, 24-hour storm.

"Confined animal feeding operation" means a lot or facility together with any associated treatment works where the following conditions are met:

1. Animals have been, are, or will be stabled or confined and fed or maintained for a total of 45 days or more in any 12-month period; and
2. Crops, vegetation forage growth, or post-harvest residues are not sustained over any portion of the operation of the lot or facility.

["~~Cover crop" means a crop, such as oats, wheat, or barley, not grown for harvest.]~~

"Critical areas" and "critical waters" means areas and waters in proximity to shellfish waters, a public water supply, or recreation or other waters where health or water quality concerns are identified by the Department of Health.

"Cumulative pollutant loading rate" means the maximum amount of an inorganic pollutant that can be applied to an area of land.

Regulations

"Density of microorganisms" means the number of microorganisms per unit mass of total solids (dry weight) in the sewage sludge.

"Department" means the Department of Environmental Quality.

"Director" means the Director of the Department of Environmental Quality, or an authorized representative.

"Discharge" means, when used without qualification, a discharge of a pollutant or any addition of any pollutant or combination of pollutants to state waters or waters of the contiguous zone or ocean other than discharge from a vessel or other floating craft when being used as a means of transportation.

"Discharge of a pollutant" means any addition of any pollutant or combination of pollutants to state waters or waters of the contiguous zone or ocean other than discharge from a vessel or other floating craft when being used as a means of transportation.

"Domestic septage" means either liquid or solid material removed from a septic tank, cesspool, portable toilet, Type III marine sanitation device, or similar treatment works that receives only domestic sewage. Domestic septage does not include liquid or solid material removed from a septic tank, cesspool, or similar treatment works that receives either commercial wastewater or industrial wastewater and does not include grease removed from a grease trap at a restaurant.

"Domestic sewage" means waste and wastewater from humans or household operations that is discharged to or otherwise enters a treatment works.

"Draft VPA permit" means a document indicating the board's tentative decision to issue, deny, modify, revoke and reissue, terminate or reissue a VPA permit. A notice of intent to terminate a VPA permit and a notice of intent to deny a VPA permit are types of draft VPA permits. A denial of a request for modification, revocation and reissuance or termination is not a draft VPA permit.

"Dry tons" means dry weight established as representative of land applied biosolids and expressed in units of English tons.

"Dry weight" means the measured weight of a sample of sewage sludge or biosolids after all moisture has been removed in accordance with the standard methods of testing and often represented as percent solids.

"Dry weight basis" means calculated on the basis of having been dried at 105°C until reaching a constant mass (i.e., essentially 100% solids content).

"Exceptional quality biosolids" means biosolids that have received an established level of treatment for pathogen control and vector attraction reduction and contain known levels of pollutants, such that they may be marketed or distributed for public use in accordance with this regulation.

"Facilities" means [, in regard to biosolids,] processes, equipment, storage devices and dedicated sites, located or

operated separately from a treatment works, utilized for sewage sludge management including, but not limited to, handling, treatment, transport, and storage of biosolids.

"Feed crops" means crops produced primarily for consumption by animals.

"Fiber crops" means crops produced primarily for the manufacture of textiles, such as flax and cotton.

"Field" means an area of land within a site where land application is proposed or permitted.

"Food crops" means crops produced primarily for consumption by humans. These include, but are not limited to, fruits, vegetables, and tobacco.

"Forest" means a tract of land thick with trees and underbrush.

"General VPA permit" means a VPA permit issued by the board authorizing a category of pollutant management activities.

"Generator" means the owner of a sewage treatment works that produces sewage sludge and biosolids.

["~~Ground water~~" "Groundwater"] means water below the land surface in the saturated zone.

"Industrial wastes" means liquid or other wastes resulting from any process of industry, manufacture, trade, or business, or from the development of any natural resources.

"Land application" means [, in regard to biosolids,] the introduction of wastewaters or sludge into or onto the ground for treatment or reuse distribution of either treated wastewater, referred to as "effluent," or stabilized sewage sludge, referred to as "biosolids," by spreading or spraying on the surface of the land, injecting below the surface of the land, or incorporating into the soil with a uniform application rate for the purpose of fertilizing the crops and vegetation or conditioning the soil. Sites approved for land application of biosolids in accordance with this regulation are not to be considered to be treatment works. Bulk disposal of stabilized sludge in a confined area, such as in landfills, is not land application. For the purpose of this regulation, the use of biosolids in agricultural research [~~is~~ and the distribution and marketing of exceptional quality biosolids are] not land application.

["Land application area" means, in regard to biosolids, the area in the permitted field, excluding the setback areas, where biosolids may be applied.]

"Land applier" means someone who land applies biosolids pursuant to a valid permit from the department as set forth in this regulation.

"Land with a high potential for public exposure" means land that the public uses frequently. This includes, but is not limited to, a public contact site and a reclamation site located in a populated area (e.g., a construction site located in a city).

"Land with a low potential for public exposure" means land that the public uses infrequently. This includes, but is not

limited to, agricultural land, forest, and a reclamation site located in an unpopulated area (e.g., a strip mine located in a rural area).

"Limitation" means any restriction imposed on quantities, rates or concentration of pollutants which are managed by pollutant management activities.

"Liner" means soil or synthetic material that has a hydraulic conductivity of 1×10^{-7} centimeters per second or less.

"Local monitor" means a person or persons employed by a local government to perform the duties of monitoring the operations of land appliers pursuant to a local ordinance.

"Local ordinance" means an ordinance adopted by counties, cities, or towns in accordance with § 62.1-44.19:3 of the Code of Virginia.

"Malodor" means an unusually strong or offensive odor associated with biosolids or sewage sludge as distinguished from odors commonly associated with biosolids or sewage sludge.

"Monitoring report" means forms supplied by the department for use in reporting of self-monitoring results of the permittee.

"Monthly average" means the arithmetic mean of all measurements taken during the month.

"Municipality" means a city, county, town, district association, ~~authority or other public body created under the law and having jurisdiction over disposal of sewage, industrial, or other wastes.~~ or other public body (including an intermunicipal agency of two or more of the foregoing entities) created by or under state law; an Indian tribe or an authorized Indian tribal organization having jurisdiction over sewage sludge or biosolids management; or a designated and approved management agency under § 208 of the federal Clean Water Act, as amended. The definition includes a special district created under state law, such as a water district, sewer district, sanitary district, utility district, drainage district, or similar entity; or an integrated waste management facility as defined in § 201(e) of the federal Clean Water Act, as amended, that has as one of its principal responsibilities the treatment, transport, use, or disposal of sewage sludge or biosolids.

"Nonpoint source" means a source of pollution, such as a farm or forest land runoff, urban storm water runoff or mine runoff that is not collected or discharged as a point source.

"Odor sensitive receptor" means, in the context of land application of biosolids, [any health care facility, such as hospitals, convalescent homes, etc. or] a building or outdoor facility regularly used to host or serve large groups of people such as schools, dormitories, [or] athletic and other recreational facilities [~~and hospitals and convalescent homes~~].

"Operate" means the act of any person who may have an impact on either the finished water quality at a waterworks or the final effluent at a sewage treatment works, such as to (i)

place into or take out of service a unit process or unit processes, (ii) make or cause adjustments in the operation of a unit process or unit processes at a treatment works, or (iii) manage sewage sludge or biosolids.

"Operator" means any individual employed or appointed by any owner, and who is designated by such owner to be the person in responsible charge, such as a supervisor, a shift operator, or a substitute in charge, and whose duties include testing or evaluation to control waterworks or wastewater works operations. Not included in this definition are superintendents or directors of public works, city engineers, or other municipal or industrial officials whose duties do not include the actual operation or direct supervision of waterworks or wastewater works.

"Other container" means either an open or closed receptacle. This includes, but is not limited to, a bucket, a box, a carton, and a vehicle or trailer with a load capacity of one metric ton or less.

"Overflow" means the unintentional discharge of wastes from any portion of a treatment works.

"Owner" means the Commonwealth or any of its political subdivisions including sanitary districts, sanitation district commissions and authorities; federal agencies; any individual; any group of individuals acting individually or as a group; or any public or private institution, corporation, company, partnership, firm, or association that owns or proposes to own a sewerage system or treatment works as defined in § 62.1-44.3 of the Code of Virginia.

"Pasture" means land on which animals feed directly on feed crops such as legumes, grasses, grain stubble, or stover.

"Pathogenic organisms" means disease-causing organisms. These include, but are not limited to, certain bacteria, protozoa, viruses, and viable helminth ova.

"Permittee" means an owner or operator who has a currently effective VPA permit issued by the board or the department.

"Person who prepares [~~sewage sludge biosolids~~]" means either the person who generates [~~sewage sludge biosolids~~] during the treatment of domestic sewage in a treatment works or the person who derives the material from sewage sludge.

"pH" means the logarithm of the reciprocal of the hydrogen ion concentration measured at 25°C or measured at another temperature and then converted to an equivalent value at 25°C.

"Place sewage sludge" or "sewage sludge placed" means disposal of sewage sludge on a surface disposal site.

"Point source" means any discernible, defined and discrete conveyance, including but not limited to any pipe, ditch, channel, tunnel, conduit, well, discrete fissure, container, rolling stock, vessel or other floating craft, from which pollutants are or may be discharged. This term does not include return flows from irrigated agricultural land.

Regulations

"Pollutant" means, in regard to wastewater, any substance, radioactive material, or heat which causes or contributes to, or may cause or contribute to, pollution. It does not mean (i) sewage from vessels; or (ii) water, gas, or other material which is injected into a well to facilitate production of oil or gas, or water derived in association with oil or gas production and disposed of in a well, if the well is used either to facilitate production or for disposal purposes if approved by Department of Mines Minerals and Energy unless the board determines that such injection or disposal will result in the degradation of ground or surface water resources.

"Pollutant" means, in regard to sewage sludge or biosolids, an organic substance, an inorganic substance, a combination of organic and inorganic substances, or a pathogenic organism that, after discharge and upon exposure, ingestion, inhalation, or assimilation into an organism either directly from the environment or indirectly by ingestion through the food chain, could, on the basis of information available to the board, cause death, disease, behavioral abnormalities, cancer, genetic mutations, physiological malfunctions (including malfunction in reproduction), or physical deformations in either organisms or offspring of the organisms.

"Pollutant limit" means a numerical value that describes the amount of a pollutant allowed per unit amount of biosolids (e.g., milligrams per kilogram of total solids), the amount of a pollutant that can be applied to a unit area of land (e.g., kilograms per hectare), or the volume of a material that can be applied to a unit area of land (e.g., gallons per acre).

"Pollutant management activity" means a treatment works with a potential or actual discharge to state waters, but which does not have a point source discharge to surface waters.

"Pollution" means such alteration of the physical, chemical, or biological properties of any state waters or soil as will, or is likely to, create a nuisance or render such waters or soil: (i) harmful or detrimental or injurious to the public health, safety, or welfare or to the health of animals, fish, or aquatic life; (ii) unsuitable despite reasonable treatment for use as present or possible future sources of public water supply; or (iii) unsuitable for recreational, commercial, industrial, agricultural, or other reasonable uses. Such alteration is also deemed to be pollution, if there occurs: (a) an alteration of the physical, chemical, or biological property of state waters or soil, or a discharge or a deposit of sewage, industrial wastes, or other wastes to state waters or soil by any owner which by itself is not sufficient to cause pollution, but which, in combination with such alteration of, or discharge, or deposit, to state waters or soil by other owners, is sufficient to cause pollution; (b) the discharge of untreated sewage by any owner into state waters or soil; or (c) the contravention of standards of air or water quality duly established by the board.

"Primary sludge" means sewage sludge removed from primary settling tanks that is readily thickened by gravity thickeners.

"Privately owned treatment works (PVOTW)" means any sewage treatment works not publicly owned.

"Process" means a system, or an arrangement of equipment or other devices that remove from waste materials pollutants including, but not limited to, a treatment works or portions thereof.

"Public contact site" means land with a high potential for contact by the public. This includes, but is not limited to, public parks, ball fields, cemeteries, and golf courses.

"Publicly owned treatment works (POTW)" means any sewage treatment works that is owned by a state or municipality. Sewers, pipes, or other conveyances are included in this definition only if they convey wastewater to a POTW providing treatment.

"Public hearing" means a fact-finding proceeding held to afford interested persons an opportunity to submit factual data, views, and arguments to the board.

"Reclamation site" means drastically disturbed land that is reclaimed using biosolids. This includes, but is not limited to, strip mines and construction sites.

"Reimbursement application" means forms approved by the department to be used to apply for reimbursement of local monitoring costs for land application of biosolids in accordance with a local ordinance.

"Run-off" means rainwater, leachate, or other liquid that drains overland on any part of a land surface and runs off of the land surface.

"Schedule of compliance" means a schedule of remedial measures including an enforceable sequence of actions or operations leading to compliance with the federal Clean Water Act (33 USC 1251 et seq.), the law, and board regulations, standards and policies.

["Setback area" means the area of land between the boundary of the land application area and adjacent features where biosolids or other managed pollutants may not be land applied.]

"Sewage" means the water-carried and nonwater-carried human excrement, kitchen, laundry, shower, bath, or lavatory wastes, separately or together with such underground, surface, storm, and other water and liquid industrial wastes as may be present from residences, buildings, vehicles, industrial establishments, or other places.

"Sewage sludge" [or "sludge"] means any solid, semisolid, or liquid [residues residue] generated during the treatment of domestic sewage in a treatment works. Sewage sludge includes, but [#] is not limited to, domestic septage; scum or solids removed in primary, secondary, or advanced wastewater treatment processes; and a material derived from sewage sludge. Sewage sludge does not include ash generated during the firing of sewage sludge in a sewage sludge incinerator or grit and screenings generated during preliminary treatment of domestic sewage in a treatment works. [~~Liquid sludge contains less than 15% dry residue by~~

weight. Dewatered sludge contains 15% or more dry residue by weight.]

"Sewage sludge unit" means land on which only sewage sludge is placed for final disposal. This does not include land on which sewage sludge is either stored or treated. Land does not include surface waters.

"Sewage sludge use or disposal" means the collection, storage, treatment, transportation, processing, monitoring, use, or disposal of sewage sludge.

"Site" means the area of land within a defined boundary where an activity is proposed or permitted.

"Sludge" means solids, residues, and precipitates separated from or created by the unit processes of a treatment works.

"Sludge management" means the treatment, handling, transportation, storage, use, distribution, or disposal of sewage sludge.

"Specific oxygen uptake rate" or "SOUR" means the mass of oxygen consumed per unit time per mass of total solids (dry weight basis) in the sewage sludge.

"State waters" means all water on the surface or under the ground wholly or partially within or bordering the state or within its jurisdiction.

"State Water Control Law (law)" means Chapter 3.1 (§ 62.1-44.2 et seq.) of Title 62.1 of the Code of Virginia.

"Store sewage sludge" or "storage of sewage sludge" means the placement of sewage sludge on land on which the sewage sludge remains for two years or less. This does not include the placement of sewage sludge on land for treatment.

"Substantial compliance" means designs and practices that do not exactly conform to the standards set forth in this chapter as contained in documents submitted pursuant to 9VAC25-32-340, but whose construction or implementation will not substantially affect health considerations or performance.

"Supernatant" is a liquid obtained from separation of suspended matter during sludge treatment or storage.

"Surface disposal site" means an area of land that contains one or more active sewage sludge units.

"Surface water" means:

1. All waters which are currently used, were used in the past, or may be susceptible to use in interstate or foreign commerce, including all waters which are subject to the ebb and flow of the tide;
2. All interstate waters, including interstate "wetlands";
3. All other waters such as inter/intrastate lakes, rivers, streams (including intermittent streams), mudflats, sandflats, "wetlands," sloughs, prairie potholes, wet meadows, playa lakes, or natural ponds the use, degradation, or destruction of which would affect or could affect interstate or foreign commerce including any such waters:

a. Which are or could be used by interstate or foreign travelers for recreational or other purposes;

b. From which fish or shellfish are or could be taken and sold in interstate or foreign commerce; or

c. Which are used or could be used for industrial purposes by industries in interstate commerce;

4. All impoundments of waters otherwise defined as surface waters of the United States under this definition;

5. Tributaries of waters identified in subdivisions 1 through 4 of this definition;

6. The territorial sea; and

7. "Wetlands" adjacent to waters, other than waters that are themselves wetlands, identified in subdivisions 1 through 6 of this definition.

"Total solids" means the materials in sewage sludge that remain as residue when the sewage sludge is dried to 103°C to 105°C.

"Toxic pollutant" means any [~~agent or material including, but not limited to, those listed under § 307(a) of the Clean Water Act (33 USC § 1317(a)) which after discharge will, on the basis of available information, cause toxicity pollutant listed as toxic under § 307 (a)(1) of the CWA or, in the case of "sludge use or disposal practices," any pollutant identified in regulations implementing § 405 (d) of the CWA]~~.

"Toxicity" means the inherent potential or capacity of a material to cause adverse effects in a living organism, including acute or chronic effects to aquatic life, detrimental effects on human health, or other adverse environmental effects.

"Treatment facility" means only those mechanical power driven devices necessary for the transmission and treatment of pollutants (e.g., pump stations, unit treatment processes).

"Treat sewage sludge" or "treatment of sewage sludge" means the preparation of sewage sludge for final use or disposal. This includes, but is not limited to, thickening, stabilization, and dewatering of sewage sludge. This does not include storage of sewage sludge.

"Treatment works" means any devices and systems used for the storage, treatment, recycling or reclamation of sewage or liquid industrial waste, or other waste or necessary to recycle or reuse water, including intercepting sewers, outfall sewers, sewage collection systems, individual systems, pumping, power and other equipment and their appurtenances; extensions, improvements, remodeling, additions, or alterations; and any works, including land that will be an integral part of the treatment process or is used for ultimate disposal of residues resulting from such treatment; or any other method or system used for preventing, abating, reducing, storing, treating, separating, or disposing of municipal waste or industrial waste, including waste in combined sewer water and sanitary sewer systems. either a federally owned, publicly owned, or privately owned device

Regulations

or system used to treat (including recycle and reclaim) either domestic sewage or a combination of domestic sewage and industrial waste of a liquid nature. Treatment works may include but are not limited to pumping, power, and other equipment and their appurtenances; septic tanks; and any works, including land, that are or will be (i) an integral part of the treatment process or (ii) used for ultimate disposal of residues or effluents resulting from such treatment. "Treatment works" does not include biosolids use on privately owned agricultural land.

"Twenty-five-year, 24-hour storm event" means the maximum 24-hour precipitation event with a probable recurrence interval of once in 25 years as established by the National Weather Service or appropriate regional or state rainfall probability information.

"Unstabilized solids" means organic materials in sewage sludge that have not been treated in either an aerobic or anaerobic treatment process.

"Upset" means an exceptional incident in which there is unintentional and temporary noncompliance with technology-based permit limitations because of factors beyond the permittee's reasonable control. An upset does not include noncompliance caused by operational error, improperly designed treatment facilities, inadequate treatment facilities, lack of preventive maintenance, or careless or improper operation.

"Use" means to manage or recycle a processed waste product in a manner so as to derive a measurable benefit as a result of such management.

"Variance" means a conditional approval based on a waiver of specific regulations to a specific owner relative to a specific situation under documented conditions for a specified period of time.

"Vector attraction" means the characteristic of [biosolids or] sewage sludge that attracts rodents, flies, mosquitoes, or other organisms capable of transporting infectious agents.

["Vegetated buffer" means a permanent strip of dense perennial vegetation established parallel to the contours of and perpendicular to the dominant slope of the field for the purposes of slowing water runoff, enhancing water infiltration, and minimizing the risk of any potential nutrients or pollutants from leaving the field and reaching surface waters.]

"Virginia Pollution Abatement (VPA) permit" means a document issued by the board, pursuant to this chapter, authorizing pollutant management activities under prescribed conditions.

"Virginia Pollutant Discharge Elimination System (VPDES) permit" means a document issued by the board pursuant to 9VAC25-31-10 et seq., authorizing, under prescribed conditions, the potential or actual discharge of pollutants from a point source to surface waters.

"Volatile solids" means the amount of the total solids in sewage sludge lost when the sewage sludge is combusted at 550°C in the presence of excess air.

"VPA application" means the standard form or forms approved by the board for applying for a VPA permit.

"Water quality standards" means the narrative statements for general requirements and numeric limits for specific requirements that describe the water quality necessary to meet and maintain reasonable and beneficial uses. Such standards are established by the board under § 62.1-44.15 (3a) of the Code of Virginia.

B. Generally used technical terms not defined in subsection A of this section or the department's latest definitions of technical terms as used to implement § 62.1-44.15 of the Code of Virginia shall be defined in accordance with "Glossary-Water and Wastewater Control Engineering" published by the American Public Health Association (APHA), American Society of Civil Engineers (ASCE), American Water Works Association (AWWA), and the Water Environment Federation (WEF).

9VAC25-32-30. Requirements and prohibitions.

A. All pollutant management activities covered under a VPA permit shall maintain no point source discharge of pollutants to surface waters except in the case of a storm event greater than the 25-year, 24-hour storm.

B. ~~4.~~ Except in compliance with a VPA permit, or another permit issued by the board, it shall be unlawful for any person to:

~~a.~~ 1. Discharge into, or adjacent to, state waters sewage, industrial wastes, other wastes, or any noxious or deleterious substances; or

~~b.~~ 2. Otherwise alter the physical, chemical or biological properties of such state waters and make them detrimental to the public health, or to animal or aquatic life, or to the use of such waters for domestic or industrial consumption, or for recreation, or for other uses.

~~2.~~ C. Any person required to obtain a permit pursuant to this chapter who discharges or causes or allows a discharge of sewage, industrial waste, other wastes or any noxious or deleterious substance into or upon state waters in violation of ~~subdivision~~ subsection ~~subdivision~~ subsection B ~~4~~ of this section; or who discharges or causes or allows a discharge that may reasonably be expected to enter state waters in violation of ~~subdivision~~ subsection B ~~4~~ of this section shall notify the department of the discharge immediately upon discovery of the discharge and, in any event, no later than 24 hours after the discovery. A written report of the unauthorized discharge shall be submitted by the owner, to the department, within five days of discovery of the discharge.

~~a.~~ 1. The written report shall contain:

~~(1)~~ a. A description of the nature of the discharge;

~~(2)~~ b. The cause of the discharge;

- ~~(3)~~ c. The date on which the discharge occurred;
- ~~(4)~~ d. The length of time that the discharge continued;
- ~~(5)~~ e. The volume of the discharge;
- ~~(6)~~ f. If the discharge is continuing, how long it is expected to continue;
- ~~(7)~~ g. If the discharge is continuing, what the expected total volume of the discharge will be; and
- ~~(8)~~ h. Any steps planned or taken to reduce, eliminate and prevent a recurrence of the present discharge or any future discharges not authorized by the permit.

~~b.~~ 2. Discharges reportable to the department under the immediate reporting requirements of other regulations are exempted from this requirement.

~~c.~~ D. VPA permits may be utilized to authorize pollutant management activities including, but not limited to, animal feeding operations, storage or land application of sewage, sludge, biosolids, industrial waste or other waste; or the complete reuse or recycle of wastewater. Point source discharges of pollutants to surface waters may be authorized by a VPDES permit (See 9VAC25-31-10 et seq. 9VAC25-31, VPDES Permit Regulation).

~~d.~~ E. No VPA permit shall be issued in the following circumstances:

- 1. Where the terms or conditions of the VPA permit do not comply with the applicable regulations or requirements of the law;
- 2. For the discharge of any radiological, chemical or biological warfare agent or high level radioactive material into state waters; or
- 3. For any pollutant management activity that is in conflict with any area-wide or basin-wide water quality control and waste management plan or policy established by the board pursuant to the law.

9VAC25-32-40. Exclusions.

The following do not require a VPA permit:

- 1. The introduction of sewage, industrial waste or other pollutants into publicly owned treatment works by indirect dischargers. Plans or agreements to switch to this method of disposal in the future do not relieve dischargers of the obligation to have and comply with VPA permits until all discharges of pollutants to state waters are eliminated;
- 2. Any introduction of pollutants from nonpoint source agricultural or silvicultural activities, including runoff from orchards, cultivated crops, pastures, range lands, and forest lands, except that this exclusion shall not apply to concentrated confined animal feeding operations;
- 3. Return flows from irrigated agricultural land;
- 4. Land disposal activity, including biosolids use or sewage sludge ~~use or~~ disposal or onsite waste treatment, when this activity is otherwise authorized by the ~~Department of Environmental Quality department;~~ [and

5. Land disposal activity, including onsite waste treatment, when this activity is authorized by a Virginia Department of Health permit; and]

[~~5-6.~~] Discharges authorized by EPA under the Safe Drinking Water Act Underground Injection Control Program (UIC), 40 CFR Part 144, and approved, in writing, by the board.

Part II

Permit Application and Issuance

9VAC25-32-60. Application for a VPA permit.

A. Duty to apply. Any owner of a pollutant management activity who does not have an effective VPA permit, except persons covered by general VPA permits or excluded under 9VAC25-32-40, shall submit a complete application to the department in accordance with this section.

~~1. a.~~ A complete VPA permit application shall be submitted by the owner of the pollutant management activity before a VPA permit can be issued. This item does not apply where general VPA permits are applicable.

~~b.~~ The board may require the submission of additional information after an application has been filed, and may suspend processing of any application until such time as the owner has supplied missing or deficient information and the board considers the application complete. Further, when the owner becomes aware that he omitted one or more relevant facts from a VPA permit application, or submitted incorrect information in a VPA permit application or in any report to the department, he shall promptly submit such facts or the correct information.

~~c.~~ In accordance with § 62.1-44.19:3 A of the Code of Virginia, no application for a permit or variance to authorize the storage of sewage sludge shall be complete unless it contains certification from the governing body of the locality in which the sewage sludge is to be stored that the storage site is consistent with all applicable ordinances. The governing body shall confirm or deny consistency within 30 days of receiving a request for certification. If the governing body does not so respond, the site shall be deemed consistent.

~~d.~~ No application for a permit to land apply biosolids in accordance with Part IX (9VAC25-32-310 et seq.) of this chapter shall be complete unless it includes the written consent of the landowner to apply biosolids on his property.

B. Time to apply.

~~2. a.~~ 1. Any owner proposing a new pollutant management activity shall submit an application for a VPA permit 180 days prior to the date planned for commencing erection, construction or expansion or employment of new processes at any site. There shall be no operation of said facilities prior to the issuance of a VPA permit.

Regulations

~~b.~~ 2. Any owner with an existing pollutant management activity that has not been permitted shall submit an application within 60 days upon being requested to by the board. The board, after determining there is pollution occurring, may allow the construction of treatment works prior to permit issuance. There shall be no operation of said treatment works prior to permit issuance.

e. 3. Owners currently managing pollutants who have effective VPA permits shall submit a new application 180 days prior to proposed facility expansions, production increases, or process modification which will:

(1) a. Result in significantly new or substantially increased amounts of pollutants being managed or a significant change in the nature of the pollutant management activity that was not anticipated and accounted for on the application for the effective VPA permit; or

(2) b. Violate or lead to violation of the terms and conditions of the effective VPA permit.

~~3. Pursuant to § 62.1-44.15:3 of the Code of Virginia, no application for a VPA permit from a privately owned treatment works serving, or designed to serve, 50 or more residences shall be considered complete unless the applicant has provided the department with notification from the State Corporation Commission that the applicant is incorporated in the Commonwealth and is in compliance with all regulations and relevant orders of the State Corporation Commission.~~

~~B.~~ C. Duty to reapply. Any permittee with an effective VPA permit shall submit a new application at least 180 days before the expiration date of the effective VPA permit unless permission for a later date has been granted by the board. Permission shall not be granted to submit an application later than the expiration date of the existing VPA permit.

D. Completeness.

1. A complete VPA permit application shall be submitted by the owner of the pollutant management activity before a VPA permit can be issued. The permit application may be submitted as a hard copy or electronically with a hard copy signature page. This item does not apply where general VPA permits are applicable.

2. The board may require the submission of additional information after an application has been filed, and may suspend processing of any application until such time as the owner has supplied missing or deficient information and the board considers the application complete. Further, when the owner becomes aware that he omitted one or more relevant facts from a VPA permit application, or submitted incorrect information in a VPA permit application or in any report to the department, he shall promptly submit such facts or the correct information.

3. In accordance with § 62.1-44.19:3 A of the Code of Virginia, no application for a permit or variance to

authorize the storage of biosolids shall be complete unless it contains certification from the governing body of the locality in [which] the biosolids is to be stored that the storage site is consistent with all applicable ordinances. The governing body shall confirm or deny consistency within 30 days of receiving a request for certification. If the governing body does not so respond, the site shall be deemed consistent.

4. No application for a permit to land apply biosolids in accordance with Part IX [~~(9VAC25-32-310 et seq.)~~ (9VAC25-32-303 et seq.)] of this chapter shall be complete unless it includes the written consent of the landowner to apply biosolids on his property.

5. Pursuant to § 62.1-44.15:3 of the Code of Virginia, no application for a VPA permit from a privately owned treatment works serving, or designed to serve, 50 or more residences shall be considered complete unless the applicant has provided the department with notification from the State Corporation Commission that the applicant is incorporated in the Commonwealth and is in compliance with all regulations and relevant orders of the State Corporation Commission.

~~E.~~ E. Information requirements. All applicants for VPA permits shall provide information ~~in accordance with to the department using the [most current] application forms provided by the [department board]~~.

F. Application for the authorization to land apply biosolids. All persons applying to land apply biosolids must provide the information in this subsection to the department using an application form approved by the department. New applicants must submit all information available at the time of permit application. The information may be provided by referencing information previously submitted to the department. The board may waive any requirement of this subsection if it has access to substantially identical information. The board may also waive any requirement of this subsection that is not of material concern for a specific permit.

1. General information.

a. Legal name and address.

b. Owner contact information [including:

(1) Name;

(2) Mailing address;

(3) Telephone number; and

(4) Email address].

c. A general description of the proposed [~~plan~~ activity] including:

(1) Name and location of generators [involved] and [their] owners [~~involved~~];

(2) Biosolids quality [; and the generator's] biosolids treatment and handling processes;

(3) Generator's odor control plan, that contains at minimum:

(a) Methods used to minimize odor in producing biosolids;

(b) Methods used to identify malodorous biosolids before land application (at the generating facility);

(c) Methods used to [identify and] abate malodorous biosolids if delivered to the field, prior to land application; and

(d) Methods used to abate malodor from biosolids if land applied;

(4) Means of biosolids transport or conveyance;

(5) Location and volume of storage proposed;

(6) A description of field staging methods;

(7) General location of sites proposed for application, and

(8) Methods of biosolids application proposed.

d. Written permission of landowners [~~and farmers~~] on [~~a~~ the most current] form approved by the board and pertinent lease agreements as may be necessary for operation of the treatment works.

e. Methods for notification of local government and obtaining compliance with local government zoning and applicable ordinances.

f. A copy of a letter of approval of the nutrient management plan for the operation from the Department of Conservation and Recreation if required in subdivision [~~3-e 3 b~~] of this subsection.

2. Design information.

a. Biosolids characterization. For each source of biosolids that the applicant proposes to land apply, the applicant must submit biosolids monitoring data for the pollutants for which limits in biosolids have been established in Part IX (9VAC25-32-303 et seq.) of this chapter, for the applicant's use or disposal practices on the date of permit application with the following conditions:

(1) When applying for authorization to land apply a biosolids source not previously included in a VPDES or [~~Virginia Pollution Abatement Permit~~ VPA permit], the biosolids shall be sampled and analyzed for PCBs. The sample results shall be submitted with the permit application or request to add the source;

(2) The board may require sampling for additional pollutants, as appropriate, on a case-by-case basis;

(3) Applicants must provide:

(a) Biosolids analytical data from a minimum of three samples taken within four and one-half years prior to the date of the permit application. Samples must be representative of the biosolids and should be taken at least one month apart. Existing data may be used in lieu of sampling done solely for the purpose of this

application [. The department may reduce the number of samples collected based on site specific conditions];

(b) The total dry tons per 365-day period of biosolids subject to this subsection that is applied to the land; and

(c) A statement that the biosolids is nonhazardous; a documentation statement for treatment and quality; and a description of how treated biosolids meets other standards in accordance with this regulation;

(4) Samples shall be collected and analyzed in accordance with analytical methods specified in [~~EPA-SW 846, Third Edition (1986) with Revision I unless an alternative has been specified in an existing biosolids permit. Samples for PCB analysis shall be collected and analyzed in accordance with EPA Method 1668B;~~ 40 CFR Part 503 (March 26, 2007) and 40 CFR Part 136 (March 26, 2007);] and

(5) The monitoring data provided must include at least the following information for each parameter:

(a) Average monthly concentration for all samples (mg/kg dry weight), based upon actual sample values;

(b) Analytical method used; and

(c) Method detection level.

b. Storage facilities. Plans and specifications for storage facilities of all biosolids to be handled, including routine and on-site storage, shall be submitted for the issuance of a certificate to construct and a certificate to operate in accordance with the Sewage Collection and Treatment Regulations (9VAC25-790) and shall depict the following information:

(1) Site layout on a recent 7.5 minute topographic quadrangle or other appropriate scaled map;

(2) Location of any required soil, geologic, and hydrologic test holes or borings;

(3) Location of the following field features within 0.25 miles of the site boundary (indicate on map) with the approximate distance from the site boundary:

(a) Water wells (operating or abandoned);

(b) Surface waters;

(c) Springs;

(d) Public water supplies;

(e) Sinkholes;

(f) Underground and surface mines;

(g) Mine pool (or other) surface water discharge points;

(h) Mining spoil piles and mine dumps;

(i) Quarries;

(j) Sand and gravel pits;

(k) Gas and oil wells;

(l) Diversion ditches;

Regulations

(m) Occupied dwellings, including industrial and commercial establishments;

(n) Landfills and dumps;

(o) Other unlined impoundments;

(p) Septic tanks and drainfields; and

(q) Injection wells.

(4) Topographic map (10-foot contour preferred) of sufficient detail to clearly [~~shown~~ show] the following information:

(a) Maximum and minimum percent slopes;

(b) Depressions on the site that may collect water;

(c) Drainage ways that may attribute to rainfall run-on to or runoff from [~~this the~~] site; and

(d) Portions of the site (if any) that are located within the 100-year floodplain;

(5) Data and specifications for the liner proposed for seepage control;

(6) Scaled plan view and cross-sectional view of the facilities showing inside and outside slopes of all embankments and details of all appurtenances;

(7) Calculations justifying impoundment capacity; and

(8) [~~Ground water~~ Groundwater] monitoring plans for facilities [~~proposing storage of liquid biosolids or supernatant, including~~ if required by the department. The groundwater monitoring plan shall include] pertinent geohydrological data to justify upgradient and downgradient well location and depth.

c. Staging. Generic plans for staging of biosolids.

d. Land application sites:

(1) DEQ control number, if previously assigned, identifying each land application field [~~or~~. If a DEQ control number has not been assigned, provide the] site [identification code used by the permit applicant to report activities] and the site's location;

(2) The site's latitude and longitude [~~to the nearest second~~ in decimal degrees to three decimal places] and the method of determination;

(3) A legible topographic map [and aerial photograph, including legend,] of proposed application areas to scale as needed to depict the following features:

(a) Property boundaries;

(b) Surface water courses;

(c) Water supply wells and springs;

(d) Roadways;

(e) Rock outcrops;

(f) Slopes;

(g) Frequently flooded areas (National Resources Conservation Service (NRCS) designation); [~~and~~

(h) Occupied dwellings within 400 feet of the property boundaries and all existing dwelling and property line setback distances;

(i) Publicly accessible properties and occupied buildings within 400 feet of the property boundaries and the associated extended setback distances; and

(j)] The gross acreage of the fields where biosolids will be applied;

(4) County map or other map of sufficient detail to show general location of the site and proposed transport vehicle haul routes to be utilized from the treatment plant;

(5) County tax maps [labeled with Tax Parcel ID or IDs] for each farm to be included in the permit, which may include multiple fields [to depict properties within 400 feet of the field boundaries];

(6) A USDA soil survey map, if available, of proposed sites for land application of biosolids;

(7) The name, mailing address, and telephone number of [~~the each~~] site owner, if different from the applicant;

(8) The name, mailing address, and telephone number of the person who applies biosolids to the site, if different from the applicant;

(9) Whether the site is agricultural land, forest, a public contact site, or a reclamation site, as such site types are defined in [~~9VAC25-31-500~~ 9VAC25-32-10];

(10) Description of agricultural practices including a list of proposed crops to be grown;

[~~(11) Whether either of the vector attraction reduction options of 9VAC25-32-685 B-9 or B-10 is met at the site and a description of any procedures employed at the time of use to reduce vector attraction properties in biosolids;~~

(12) For projects utilizing frequent application of biosolids at agronomic rates the following additional site information will be necessary:

(a) Information specified in subdivisions 2 a and 4 of this subsection;

(b) Representative soil borings and test pits to a depth of five feet or to bedrock if shallower, are to be coordinated for each major soil type and tests performed and data collected on soil type; soil texture for each horizon (USDA classification); soil color for each horizon; depth from surface to mottling and bedrock if less than two feet; depth from surface to subsoil restrictive layer; indicated infiltration rate (surface soil) and indicated permeability of subsoil restrictive layer;

(c) Additional soil testing in accordance with Table 1 of ~~9VAC25-32-460~~; and

(d) Ground water monitoring plans for land treatment area including pertinent geohydrologic data to justify upgradient and downgradient well location and depth;

~~(13) (11)] The following information for each land application site that has been identified at the time of permit application, if the applicant intends to apply bulk biosolids subject to the cumulative pollutant loading rates in 9VAC25-32-356 [~~Table 2~~ Table 3] to the site:~~

~~(a) Whether the applicant has contacted the permitting authority in the state where the bulk biosolids subject to 9VAC25-32-356 [~~Table 2~~ Table 3] will be applied, to ascertain whether bulk biosolids subject to 9VAC25-32-356 [~~Table 2~~ Table 3] has been applied to the site on or since July 20, 1993, and if so, the name of the permitting authority and the name and phone number of a contact person at the permitting authority; and~~

~~(b) Identification of facilities other than the applicant's facility that have sent, or are sending, biosolids subject to the cumulative pollutant loading rates in 9VAC25-32-356 [~~Table 2~~ Table 3] to the site since July 20, 1993, if, based on the inquiry in subdivision 8 d (1) of this subsection, bulk biosolids subject to cumulative pollutant loading rates in 9VAC25-32-356 [~~Table 2~~ Table 3] has been applied to the site since July 20, 1993 [~~and~~~~

~~(14) If not all land application sites have been identified at the time of permit application, the applicant must submit a land application plan that, at a minimum:~~

~~(a) Describes the geographical area covered by the plan;~~

~~(b) Identifies the site selection criteria;~~

~~(c) Describes how the site or sites will be managed;~~

~~(d) Provides for advance notice to the department of specific land application sites in a manner prescribed by 9VAC25-32-515; and~~

~~(e) Provides for advance public notice of land application sites in a manner prescribed by 9VAC25-32-140] .~~

3. A biosolids [~~operations~~] management plan shall be provided that includes the following minimum site specific information at the time of permit application.

a. Description of operation: A comprehensive, general description of the operation [~~shall be provided, including biosolids source or sources; quantities; flow diagram illustrating treatment works biosolids flows and solids handling units; site description; methodology of biosolids handling for application periods, including storage and nonapplication period storage; and alternative management methods when storage is not provided as required by 9VAC25-32-60] .~~

b. A nutrient management plan approved by the Department of Conservation and Recreation [~~shall be as~~] required for application sites prior to board authorization under the following conditions:

(1) Sites operated by an owner or lessee of a confined animal feeding operation, as defined in subsection A of § 62.1-44.17:1 of the Code of Virginia, or confined

poultry feeding operation, as defined in subsection A of § 62.1-44.17:1.1 of the Code of Virginia;

(2) Sites where land application more frequently than once every three years at greater than 50% of the annual agronomic rate is proposed; [~~and~~]

(3) Mined [or disturbed] land sites where land application is proposed at greater than agronomic rates [; or

(4) Other sites based on site-specific conditions that increase the risk that land application may adversely impact state waters.]

4. Biosolids transport.

a. [~~Description and specifications on the bed or the tank vehicle~~ General description of transport vehicles to be used] .

[~~b. Haul routes to be used from the biosolids generator to the storage unit and land application sites.~~

e. b.] Procedures for biosolids offloading at the biosolids facilities and the land application site together with spill prevention, cleanup (including vehicle cleaning); field reclamation and emergency spill notification and cleanup measures.

[~~c.] Voucher system used for documentation and recordkeeping.~~

5. Field operations.

a. Storage.

(1) Routine storage - supernatant handling and disposal, biosolids handling and loading of transport vehicles, equipment cleaning, freeboard maintenance, and inspections for structural integrity.

(2) On-site storage - procedures for department or board approval and implementation.

(3) Staging - procedures to be followed including either designated site locations provided in the "Design Information" or the specific site criteria for such locations including the liner or cover requirements and the time limit assigned for such use.

(4) [~~Field reclamation~~ Reestablishment] of offloading [~~(staging)~~ and staging] areas.

b. Application methodology.

(1) Description and specifications on spreader vehicles.

(2) Procedures for calibrating equipment for various biosolids contents to ensure uniform distribution and appropriate loading rates on a day-to-day basis.

(3) Procedures used to ensure that operations address the following constraints: application of biosolids to frozen ground, pasture or hay fields, crops for direct human consumption and saturated or ice-covered or snow-covered ground; [~~maintenance of buffer zones;~~ establishment of setback distances;] slopes; prohibited access for beef and dairy animals, and soil pH

Regulations

requirements; and proper site specific biosolids loading rates on a field-by-field basis.

c. Odor control plan for land applier. Include at a minimum:

(1) Methods used to identify and abate malodorous biosolids in the field prior to land application, and

(2) Methods used to abate malodorous biosolids if land applied.

6. An applicant for a permit authorizing the land application of biosolids shall provide to the department, and to each locality in which the applicant proposes to land apply biosolids, written evidence of financial responsibility. Evidence of financial responsibility shall be provided in accordance with the requirements specified under Article 6 (9VAC25-32-770 et seq.) of Part IX of this chapter.

9VAC25-32-80. Conditions applicable to all VPA permits.

A. Duty to comply. The permittee shall comply with all conditions of the VPA permit. Any permit noncompliance is a violation of the law, and is grounds for enforcement action, permit termination, revocation, modification, or denial of a permit renewal application.

B. Duty to halt or reduce activity. It shall not be a defense for a permittee in an enforcement action that it would have been necessary to halt or reduce the permitted activity in order to maintain compliance with the conditions of the VPA permit.

C. Duty to mitigate. The permittee shall take all reasonable steps to minimize, correct or prevent any pollutant management activity in violation of the VPA permit which has a reasonable likelihood of adversely affecting human health or the environment.

D. Proper operation and maintenance. The permittee shall be responsible for the proper operation and maintenance of all treatment works, systems and controls which are installed or used to achieve compliance with permit conditions. Proper operation and maintenance includes effective plant performance, adequate funding, adequate licensed operator staffing, and adequate laboratory and process controls, including appropriate quality assurance procedures.

E. Permit action.

1. A VPA permit may be modified, revoked and reissued, or terminated as set forth in this chapter.

2. If a permittee files a request for a permit modification, revocation, or termination, or files a notification of planned changes, or anticipated noncompliance, the permit terms and conditions shall remain effective until the request is acted upon by the board. This provision shall not be used to extend the expiration date of the effective VPA permit.

3. VPA permits may be modified, revoked and reissued or terminated upon the request of the permittee or interested

persons, or upon the board's initiative, to reflect the requirements of any changes in the statutes or regulations.

4. VPA permits continued under 9VAC25-32-130 remain effective and enforceable.

F. Inspection and entry. Upon presentation of credentials, any duly authorized agent of the board may, at reasonable times and under reasonable circumstances:

1. Enter upon any permittee's property, public or private, and have access to records required by the VPA permit;

2. Have access to, inspect and copy any records that must be kept as part of VPA permit conditions;

3. Inspect any facility's equipment (including monitoring and control equipment) practices or operations regulated or required under the VPA permit; and

4. Sample or monitor any substances or parameters at any locations for the purpose of assuring VPA permit compliance or as otherwise authorized by law.

G. Duty to provide information.

1. The permittee shall furnish to the department, within a reasonable time, any information which the board may request to determine whether cause exists for modifying, revoking and reissuing, terminating the VPA permit, or to determine compliance with the VPA permit. The permittee shall also furnish to the department, upon request, copies of records required to be kept by the permittee.

2. Plans, specifications, maps, conceptual reports and other relevant information shall be submitted as requested by the board prior to commencing construction.

H. Monitoring and records.

1. Samples and measurements taken for the purpose of monitoring shall be representative of the monitored activity.

2. The permittee shall retain records of all monitoring information, including all calibration and maintenance records and all original strip chart recordings for continuous monitoring instrumentation, copies of all reports required by the VPA permit, and records of all data used to complete the application for the VPA permit, for a period of at least three years or in the case of activities regulated under Part IX (9VAC25-32-310 et seq.) of this chapter, at least five years from the date of the sample, measurement, report or application. This period may be extended by request of the board at any time.

~~Records related to biosolids data and information specified in agreements between generator, owner, agents, landowners and farmers shall be described and maintained for a minimum period of five years or the duration of the permit or subsequent revisions if longer than five years.~~

3. Records of monitoring information shall include:

a. The date, exact place and time of sampling or measurements;

- b. The name of the individual or individuals who performed the sampling or measurements;
- c. The date or dates analyses were performed;
- d. The name of the individual or individuals who performed the analyses;
- e. The analytical techniques or methods supporting the information such as observations, readings, calculations and bench data used; and
- f. The results of such analyses.

4. Monitoring shall be conducted according to analytical methods promulgated pursuant to § 304(h) of the Clean Water Act (33 USC § 1251 et seq.) and listed in the Code of Federal Regulations at 40 CFR Part 136 (1995). Any other acceptable test procedure not listed in 40 CFR Part 136 (1995) shall be specified in the VPA permit.

5. Records related to biosolids data and information specified in agreements between generator, owner, agents, landowners, and farmers shall be described and maintained for a minimum period of five years or the duration of the permit or subsequent revisions if longer than five years.

I. Reporting requirements.

- 1. The permittee shall give prompt notice to the department of any planned changes to the design or operation of the pollutant management activity.
- 2. If any unusual or extraordinary discharge including a bypass or upset should occur from a treatment works and the discharge enters or could be expected to enter state waters, the owner shall promptly notify, in no case later than 24 hours, the department by telephone after the discovery of the discharge. This notification shall provide all available details of the incident, including any adverse effects on aquatic life and the known number of fish killed. The permittee shall reduce the report to writing and shall submit it to the department within five days of discovery of the discharge in accordance with subdivision 6 of this subsection. Unusual and extraordinary discharges include but are not limited to any discharge resulting from:
 - a. Unusual spillage of materials resulting directly or indirectly from processing operations;
 - b. Breakdown of processing or accessory equipment;
 - c. Failure or taking out of service of some or all of the treatment works; and
 - d. Flooding or other acts of nature.
- 3. The permittee shall give at least 10 days advance notice to the department of any planned changes to the facility or activity which may result in noncompliance.
- 4. Monitoring results shall be reported at the intervals specified in the applicable VPA permit.
 - a. Monitoring results shall be reported in a format acceptable to the board.

b. If a permittee monitors the pollutant management activity, at a sampling location specified in the VPA permit, for any pollutant more frequently than required by the VPA permit using approved analytical methods, the permittee shall report the results of this monitoring on the monitoring report.

c. If the permittee monitors the pollutant management activity, at a sampling location specified in the VPA permit, for any pollutant that is not required to be monitored by the VPA permit, and uses approved analytical methods the permittee shall report the results with the monitoring report.

d. Calculations for all limitations which require averaging of measurements shall utilize an arithmetic mean unless otherwise specified in the VPA permit.

5. Reports of compliance or noncompliance with or any progress report on interim and final requirements contained in any compliance schedule in the VPA permit shall be submitted no later than 14 days following each scheduled date.

6. 24-hour reporting.

a. The permittee shall report any noncompliance which may adversely affect state waters or may endanger public health. An oral report must be provided [to the department] as soon as possible, but in no case later than 24 hours from the time the permittee becomes aware of the circumstances. A written report shall be submitted within five days and shall contain a description of the noncompliance and its cause; the period of noncompliance including exact dates and times, and, if the noncompliance has not been corrected, how long it is expected to continue, steps planned or taken to reduce, eliminate and prevent a recurrence of the noncompliance. The board may waive the written report requirements on a case-by-case basis if the oral report has been received within 24 hours and no adverse impact on state waters has been reported. All other noncompliance reports which may not adversely affect state waters shall be submitted with the monitoring report. Reports shall include overflows.

b. The following shall be included as information which must be reported within 24 hours under this subdivision:

- (1) Any unanticipated bypass; and
- (2) Any upset which causes a discharge to surface waters.

J. Bypass.

- 1. A bypass of the treatment works is prohibited except as provided herein.
- 2. If the permittee knows in advance of the need for a bypass, he shall notify the department promptly at least 10 days prior to the bypass. After considering its adverse effects, the board may approve an anticipated bypass if:

Regulations

a. The bypass will be unavoidable to prevent loss of human life, personal injury, or severe property damage ("severe property damage" means substantial physical damage to property, damage to the treatment facilities which causes them to become inoperable, or substantial and permanent loss of natural resources which can reasonably be expected to occur in the absence of a bypass. Severe property damage does not mean economic loss caused by delays in production); and

b. There are no feasible alternatives to bypass such as the use of auxiliary treatment facilities, retention of untreated waste, or maintenance during normal periods of equipment downtime. However, if bypass occurs during normal periods of equipment downtime or preventive maintenance and in the exercise of reasonable engineering judgment the permittee could have installed adequate backup equipment to prevent such bypass, this exclusion shall not apply as a defense.

3. If an unplanned bypass occurs, the permittee shall notify the department as soon as possible, but in no case later than 24 hours, and shall take steps to halt the bypass as early as possible. This notification will be a condition for defense to an enforcement action that an unplanned bypass met the conditions in subdivision 2 of this subsection and in light of the information reasonably available to the owner at the time of the bypass.

K. Upset. A permittee may claim an upset as an affirmative defense to an action brought for noncompliance. In any enforcement proceedings a permittee shall have the burden of proof to establish the occurrence of any upset. In order to establish an affirmative defense of upset, the permittee shall present properly signed, contemporaneous operating logs or other relevant evidence that shows:

1. That an upset occurred and that the cause can be identified;
2. That the permitted facility was at the time being operated efficiently and in compliance with proper operation and maintenance procedures;
3. That the 24-hour reporting requirements to the department were met; and
4. That the permittee took all reasonable steps to minimize or correct any adverse impact on state waters resulting from noncompliance with the VPA permit.

L. Signature requirements. All applications, reports, or information submitted to the department shall be signed and certified as required in 9VAC25-32-70.

M. Transfers. A VPA permit is not transferable to any person except after notice to the department according to 9VAC24-32-230. The board may require modification or revocation and reissuance of the VPA permit to change the name of the permittee and incorporate such other requirements as may be necessary.

9VAC25-32-100. Establishing limitations and other VPA permit conditions.

A. In addition to the conditions established in 9VAC25-32-80 and 9VAC25-32-90, each VPA permit shall include conditions meeting the following requirements where applicable.

1. Determination of limitations. VPA permit limitations and conditions shall be established based on the nature of the pollutant management activity in order to ensure compliance with technology-based limitations, water quality standards, the law and all regulations promulgated thereunder. These limitations and conditions may include, but are not limited to, duration of VPA permits, monitoring requirements, limitations to control toxic pollutants, best management practices and schedules of compliance.

2. Duration of VPA permits. VPA permits issued under this regulation shall have an effective date and an expiration date which will determine the life of the VPA permit. VPA permits shall be effective for a fixed term not to exceed 10 years as specified in the VPA permit. The term of the VPA permits shall not be extended by modification beyond the maximum duration. The VPA permit shall expire at the end of the term unless an application for a new VPA permit has been timely filed as required by this chapter and the board is unable, through no fault of the permittee, to issue a new VPA permit before the expiration date of the previous VPA permit.

~~3.~~ B. Monitoring requirements.

~~a.~~ 1. All VPA permits may specify:

(~~1~~) a. Requirements concerning the proper use, maintenance and installation, when appropriate, of monitoring equipment or methods;

(~~2~~) b. Required monitoring including type, intervals, and frequency sufficient to yield data which are representative of the monitored activity and including, when appropriate, continuous monitoring; and

(~~3~~) c. Applicable reporting requirements based upon the impact of the regulated activity on water quality.

~~b.~~ 2. VPA permits may include requirements to report monitoring results with a frequency dependent on the nature and effect of the pollutant management activity.

~~c.~~ 3. In addition, the following monitoring requirements may be included in the VPA permits:

(~~1~~) a. Mass or other measurements specified in the VPA permit for each pollutant of concern;

(~~2~~) b. The volume of waste, wastewater, biosolids, or sludge managed by the activity; and

(~~3~~) c. Other measurements as appropriate.

4. C. Best Management Practices (BMPs). The VPA permit shall require the use of BMPs to control or abate pollutants where numeric limits are infeasible, and the VPA permit may include BMPs in addition to numeric limits where BMPs are

necessary to achieve limitations and standards or to carry out the purpose and intent of the law.

~~5. D.~~ Sludge disposal. The VPA permit shall include, where appropriate, specific requirements for disposal of all sludge.

~~6. E.~~ ~~Sewage sludge~~ Biosolids land application. Where, because of site-specific conditions, including soil type, identified during the permit application review process, the department determines that special requirements are necessary to protect the environment or the health, safety or welfare of persons residing in the vicinity of a proposed land application site, the department may incorporate in the permit at the time it is issued reasonable special conditions regarding [~~buffering setback distances~~], transportation routes, slope, material source, methods of handling and application, and time of day restrictions exceeding those required by this regulation. The permit applicant shall have at least 14 days in which to review and respond to the proposed conditions.

~~7. F.~~ Schedules of compliance. The VPA permit may specify a schedule, when appropriate, leading to compliance with the VPA permit as soon as possible. When schedules of compliance are applicable the following shall be incorporated:

- ~~a. 1.~~ Schedule or schedules of compliance shall require the permittee to take specific steps where necessary to achieve expeditious compliance with the VPA permit;
- ~~b. 2.~~ The schedule of compliance shall set forth interim time periods not more than one year apart for the submission of reports of progress toward completion of each requirement; and
- ~~c. 3.~~ Schedule or schedules of compliance may be modified by modification of the VPA permit for good cause beyond the control of the permittee (e.g., act of God, strike, flood, material shortage).

Part III
Public Involvement

9VAC25-32-140. Public notice of VPA permit action and public comment period.

A. Draft VPA permits.

- ~~A. 1.~~ Every draft VPA permit shall be given public notice, paid for by the owner, by publication once a week for two successive weeks in a newspaper of general circulation in the area affected by the pollutant management activity.
- ~~B. 2.~~ Interested persons shall have a period of at least 30 days following the date of the initial newspaper public notice to submit written comments on the tentative decision and to request a public hearing.
- ~~C. 3.~~ The contents of the public notice of an application for a VPA permit shall include:
 - ~~1. a.~~ The name and address of the applicant. If the location of the pollutant management activity differs from the address of the applicant the notice shall also state the

location of the pollutant management activity including storage and land application sites;

- ~~2. b.~~ A brief description of the business or activity conducted at the facility;
- ~~3. c.~~ A statement of the tentative determination to issue or deny a VPA permit;
- ~~4. d.~~ A brief description of the final determination procedure;
- ~~5. e.~~ The address and phone number of a specific person at the state office from whom further information may be obtained; and
- ~~6. f.~~ A brief description of how to submit comments and request a hearing.

~~D. Public notice shall not be required for submission or approval of plans and specifications or conceptual engineering reports not required to be submitted as part of the application.~~

B. VPA permit application.

~~E. 1.~~ Upon receipt of an application for a the issuance of a new or modified permit or for a modification of a permit, the board department shall notify in writing the locality wherein the pollutant management activity does or is proposed to take place. This notification shall, at a minimum, include:

~~1. Cause to be notified, in writing, the locality wherein the pollutant management activity does or is proposed to take place. This notification shall, at a minimum, include:~~

- a. The name of the applicant;
- b. The nature of the application and proposed pollutant management activity; ~~and~~
- c. The availability and timing of any comment period; and

~~e. d.~~ Upon request, any other information known to, or in the possession of, the board or the department regarding the application except as restricted by 9VAC25-32-150.

~~2. Establish~~ Whenever the department receives an application for a new permit for land application of biosolids or land disposal of treated sewage, stabilized sewage sludge, or stabilized septage, or an application to reissue with the addition of sites increasing acreage by 50% or more of that authorized in the initial permit, the department shall establish a date for a public meeting to discuss technical issues relating to proposals for land application of biosolids or land disposal of treated sewage, stabilized sewage sludge or stabilized septage. The department shall give notice of the date, time, and place of the public meeting and a description of the proposal by publication in a newspaper of general circulation in the city or county where the proposal is to take place. Public notice of the scheduled meeting shall occur no fewer than seven ~~or~~ nor more than 14 days prior to the meeting. The ~~board~~ department shall not issue the permit until the public

Regulations

meeting has been held and comment has been received from the local governing body or until 30 days have lapsed from the date of the public meeting.

3. Following the submission of an application for a new permit for land application of biosolids or land disposal of treated sewage, stabilized sewage sludge, or stabilized septage, [~~DEQ~~ the department] shall [make a good faith effort to] notify or cause to be notified persons residing on property bordering the sites that contain the proposed land application fields. This notification shall be in a manner selected by the department. For the purposes of this subsection, "site" means all contiguous land under common ownership, but which may contain more than one tax parcel.

4. Public notice shall not be required for submission or approval of plans and specifications or conceptual engineering reports not required to be submitted as part of the application.

C. Following the submission of an application to add a site that is not contiguous to sites included in an existing permit authorizing the land application of biosolids:

1. The department shall notify persons residing on property bordering such site and shall receive written comments from those persons for a period of 30 days. Based upon written comments, the department shall determine whether additional site-specific requirements should be included in the authorization for land application at the site.

2. An application for any permit amendment to increase the acreage authorized by the initial permit by 50% or more shall be considered a major modification and shall be treated as a new application for purposes of public notice and public hearings. The increase in acreage for the purpose of determining the need for the public meeting is the sum of all acreage that has been added to the permit since the last public meeting, plus that proposed to be added.

~~F. D.~~ Before issuing any permit, if the [board ~~department~~] finds that there are localities particularly affected by the permit, the [board ~~department~~] shall:

1. Publish, or require the applicant to publish, a notice in a local paper of general circulation in the localities affected at least 30 days prior to the close of any public comment period. Such notice shall contain a statement of the estimated local impact of the proposed permit, which at a minimum shall include information on the specific pollutants involved and the total quantity of each which may be discharged; and

2. Mail the notice to the chief elected official and chief administrative officer and planning district commission for those localities.

Written comments shall be accepted by the [board ~~department~~] for at least 15 days after any public hearing on the permit, unless the [board votes ~~department~~

~~decides~~] to shorten the period. For the purposes of this section, the term "locality particularly affected" means any locality which bears any identified disproportionate material water quality impact which would not be experienced by other localities.

~~G. When a site is to be added to an existing permit authorizing land application of biosolids, the department shall notify persons residing on property bordering such site, and shall receive written comments from those persons for a period not to exceed 30 days. Based upon the written comments, the department shall determine whether additional site specific requirements should be included in the authorization for land application at the site.~~

9VAC25-32-240. Minor modification.

A. Upon request of the permittee, or upon board initiative with the consent of the permittee, minor modifications may be made in the VPA permit without following the public involvement procedures.

B. Minor modification may only:

1. Correct typographical errors;

2. Require reporting by the permittee at a frequency other than that required in the VPA permit;

3. Change an interim compliance date in a schedule of compliance to no more than 120 days from the original compliance date and provided it will not interfere with the final compliance date;

4. Allow for a change in name, ownership or operational control when the board determines that no other change in the VPA permit is necessary, provided that a written agreement containing a specific date for transfer of VPA permit responsibility, coverage and liability from the current to the new permittee has been submitted to the department;

5. Delete the listing of a land application site when the pollutant management activity is terminated and does not result in an increase of pollutants which would exceed VPA permit limitations;

6. Reduce VPA permit limitations to reflect a reduction in the permitted activity when such reduction results from a shutdown of processes or pollutant generating activities or from connection of the permitted activity to a POTW;

7. Change plans and specifications where no other changes in the VPA permit are required;

8. Authorize treatment facility expansions, production increases or process modifications which will not cause a significant change in the quantity of pollutants being managed or a significant change in the nature of the pollutant management activity; or

9. Delete VPA permit limitation or monitoring requirements for specific pollutants when the activities generating these pollutants are terminated.

C. An application for any permit amendments to increase the acreage authorized by the [initial] permit ~~by 50% or more shall be treated as a new application for purposes of public notice and public hearings [shall not be considered a minor modification and shall require the public involvement procedures outlined in 9VAC25-32-140 C]~~.

9VAC25-32-260. General VPA permits.

The board may issue a general VPA permit in accordance with the following:

1. Sources. A general VPA permit may be written to regulate a category of pollutant management activities that:
 - a. Involve the same or similar types of operations;
 - b. Manage the same or similar types of wastes;
 - c. Require the same VPA permit limitations or operating conditions;
 - d. Require the same or similar monitoring; and
 - e. In the opinion of the board, are more appropriately controlled under a general VPA permit than under individual VPA permits.
2. Administration.
 - a. General VPA permits will be issued, modified, revoked and reissued, or terminated pursuant to the law and the ~~board's Public Participation Guidelines (9VAC25-10-10 et seq.)~~ Administrative Process Act (§ 2.2-4000 et seq. of the Code of Virginia).
 - b. The board may require any person operating under a general VPA permit to apply for and obtain an individual VPA permit. Interested persons may petition the board to take action under this subdivision. Cases where an individual VPA permit may be required include the following:
 - (1) Where the pollutant management activity is a significant contributor of pollution;
 - (2) Where the owner is not in compliance with the conditions of the general VPA permit;
 - (3) When a water quality management plan containing requirements applicable to the pollutant management activity is approved; or
 - (4) When a permitted activity no longer meets the general VPA permit conditions.
 - c. Any owner operating under a general VPA permit may request to be excluded from the coverage of the general VPA permit by applying for an individual VPA permit.
 - d. When an individual VPA permit is issued to an owner the applicability of the general VPA permit to the individual permittee is automatically terminated on the effective date of the individual VPA permit.
 - e. When a general VPA permit is issued which applies to an owner already covered by an individual VPA permit, such owner may request exclusion from the provisions of

the general VPA permit and subsequent coverage under an individual VPA permit.

f. A general VPA permit may be revoked as to an individual owner for any of the reasons set forth in 9VAC25-32-210 or subdivision 2 b of this section subject to appropriate opportunity for a hearing.

9VAC25-32-300. Transition.

~~A. Effective July 24, 1996, the following will occur:~~

- ~~1. All VPA applications received after that date will be processed in accordance with this regulation.~~
- ~~2. Any owner holding a No Discharge Certificate will be notified of the deadline for applying for a VPA permit, unless this notification has already been made. All such notifications shall be completed by July 1, 1998. Upon notification that a VPA permit is necessary for the pollutant management activity authorized by the No-Discharge Certificate, the permittee shall have 180 days to apply for a VPA permit. If a VPA permit is required, the existing No Discharge Certificate will remain in effect until the VPA permit is issued. Concurrent with the issuance of the VPA permit, the No Discharge Certificate will be revoked subject to appropriate notice and opportunity for public hearing. Notwithstanding the foregoing, all No Discharge Certificates which do not bear an expiration date shall terminate no later than July 1, 1999.~~

~~B. A. Permits issued prior to January 1, 2008, by the Department of Health under the authority of the State Board of Health prior to January 1, 2008, shall continue in force until expired, reissued, amended, or terminated in accordance with the permit or this regulation. All owners holding biosolids use construction or operation permits as of January 1, 2008, shall submit an application for a Virginia Pollution Abatement Permit in accordance with this regulation within 180 days before the date of expiration of permits issued prior to January 1, 2008, or at the time of any modification request submitted after January 1, 2008, or by June 1, 2008, whichever is later. All owners of biosolids use facilities shall comply with the applicable requirements set forth in the operational regulations of Part IX (9VAC25-32-310 et seq.) of this chapter.~~

B. All owners holding active biosolids use permits as of January 1, 2008, shall submit an application for a Virginia Pollution Abatement Permit in accordance with this regulation at least 180 days before the expiration date of permits issued prior to January 1, 2008, or by June 30, 2012, whichever comes first.

C. All owners of biosolids use facilities shall comply with the applicable requirements set forth in the operational regulations of Part IX (9VAC25-32-303 et seq.) of this chapter.

D. Notwithstanding the foregoing, all VDH-BUR permits shall terminate no later than December 31, 2012, [or 12

Regulations

months after the effective date, whichever is later,] if an administratively complete VPA application for the activity authorized by the VDH-BUR permit has not been submitted to the department.

Part IX
Biosolids Program

Article 1
Procedures and Requirements

9VAC25-32-303. Purpose and applicability.

A. This part establishes standards, which consist of general requirements, pollutant limits, management practices, and operational standards, for the final use of biosolids or disposal of sewage sludge generated during the treatment of domestic sewage in a treatment works. Standards are included in this part for biosolids applied to the land. Also included in this part are pathogen and alternative vector attraction reduction requirements for biosolids applied to the land.

B. The standards in this part also include the frequency of monitoring and recordkeeping requirements when biosolids is applied to the land.

C. Applicability.

1. This part applies to any person who prepares biosolids or applies biosolids to the land.
2. This part applies to biosolids applied to the land.
3. This part applies to land where biosolids is applied.

9VAC25-32-305. Permits.

A. No owner shall cause or allow any land application, marketing, or distribution of biosolids except in compliance with a permit issued by the board that authorizes these activities.

B. A separate biosolids use permit shall be issued for each political jurisdiction (county or city) where land application is proposed.

C. No person shall land apply Class B biosolids on any land in Virginia unless that land has been identified in an application to issue, reissue or modify a permit and approved by the board.

D. No person shall land apply, market [,] or distribute biosolids in Virginia unless the biosolids [source] has been approved by the board.

9VAC25-32-307. Relationship to other regulations.

A. Disposal of sewage sludge in a municipal solid waste landfill unit that complies with the requirements in the Virginia Solid Waste Management Regulation [~~9VAC20-80~~ (9VAC20-81)] constitutes compliance with § 405 (d) of the federal Clean Water Act.

B. Any person who prepares sewage sludge that is disposed in a municipal solid waste landfill unit shall ensure that the sewage sludge meets the requirements in [~~9VAC20-80~~ 9VAC20-81] concerning the quality of materials disposed in a municipal solid waste landfill.

Part IX
Biosolids Program

Article 1
Definitions and Procedures

9VAC25-32-310. Definitions. (Repealed.)

A. For the purposes of this part the following definitions shall apply:

"Biosolids" means a sewage sludge that has received an established treatment for required pathogen control and is treated or managed to reduce vector attraction to a satisfactory level and contains acceptable levels of pollutants, such that it is acceptable for use for land application, marketing or distribution in accordance with this regulation.

"Critical areas/waters" means areas/waters in proximity to shellfish waters, a public water supply, recreation or other waters where health or water quality concerns are identified by the board or the Department of Health.

"Dry tons" means dry weight established as representative of land applied biosolids and expressed in units of English tons.

"Dry weight" means the measured weight of a sample of sewage sludge or biosolids after all moisture has been removed in accordance with the standard methods of testing and often represented as a percent solids.

"Effluent limitations" means schedules of compliance, prohibitions, permit requirements, established under state or federal law for control of sewage discharges.

"Exceptional quality biosolids" means biosolids that have received an established level of treatment for pathogen control and vector attraction reduction and contain known levels of pollutants, such that they may be marketed or distributed for public use in accordance with this regulation.

"Facilities" means processes, equipment, storage devices and dedicated sites, located or operated separately from a treatment works, utilized for sewage sludge management, including but not limited to, handling, treatment, transport and storage of biosolids.

"Generator" means the owner of a sewage treatment works that produces sewage sludge and biosolids.

"Industrial wastes" means liquid or other wastes resulting from any process of industry, manufacture, trade or business, or from the development of any natural resources.

"Land application" means the distribution of either treated wastewater of acceptable quality, referred to as effluent, or stabilized sewage sludge of acceptable quality, referred to as biosolids, upon, or insertion into, the land with a uniform application rate for the purpose of utilization, or assimilation. Bulk disposal of stabilized sludge in a confined area, such as in landfills, is not land application. Sites approved for land application of biosolids in accordance with this regulation are not to be considered to be treatment works.

"Land applier" means someone who land applies biosolids pursuant to a valid permit from the department as set forth in this regulation.

"Local monitor" means a person or persons employed by local government to perform the duties of monitoring the operations of land appliers pursuant to a local ordinance.

"Local ordinance" means an ordinance adopted by counties, cities or towns in accordance with § 62.1-44.19:3 of the Code of Virginia.

"Operate" means the act of any person who may have an impact on either the finished water quality at a waterworks or the final effluent at a sewage treatment works, such as to (i) place into or take out of service a unit process or unit processes, (ii) make or cause adjustments in the operation of a unit process or unit processes at a treatment works, or (iii) manage sewage sludge or biosolids.

"Owner" means the Commonwealth or any of its political subdivisions including sanitary districts, sanitation district commissions and authorities, federal agencies, any individual, any group of individuals acting individually or as a group, or any public or private institution, corporation, company, partnership, firm or association that owns or proposes to own a sewerage system or treatment works as defined in § 62.1-44.3 of the Code of Virginia.

"Permit" means an authorization granted by the board to construct, or operate, facilities and specific sites utilized for biosolids management, including land application, marketing and distribution of biosolids.

"Permittee" means a person, firm, corporation, political subdivision or other entity holding a permit approved by the board for the land application, storage or distribution of biosolids as provided for in this regulation.

"Pollutant" means any substance, radioactive material, or waste heat that causes or contributes to, or may cause or contribute to, pollution.

"Pollution" means such alteration of the physical, chemical or biological properties of any state waters or soil as will, or is likely to, create a nuisance or render such waters or soil (i) harmful or detrimental or injurious to the public health, safety or welfare, or to the health of animals, fish or aquatic life; (ii) unsuitable despite reasonable treatment for use as present or possible future sources of public water supply; or (iii) unsuitable for recreational, commercial, industrial, agricultural or for other reasonable uses. Such alteration is also deemed to be pollution, if there occurs: (a) an alteration of the physical, chemical or biological property of state waters or soil, or a discharge or a deposit of sewage, industrial wastes or other wastes to state waters or soil by any owner which by itself is not sufficient to cause pollution, but which, in combination with such alteration of, or discharge, or deposit, to state waters or soil by other owners, is sufficient to cause pollution; (b) the discharge of untreated sewage by any owner into state waters or soil; or (c) the contravention of

standards of air or water quality duly established by the State Water Control Board.

9VAC25-32-313. General requirements.

A. No person shall apply biosolids to the land except in accordance with the requirements in this article.

B. No person shall apply bulk biosolids to the land if it is likely to adversely affect a threatened or endangered species listed in 9VAC25-260-320 or § 4 of the Endangered Species Act (16 USC § 1533) or if the land application is likely to adversely affect its designated critical habitat.

C. No person shall apply bulk biosolids subject to the cumulative pollutant loading rates in 9VAC25-32-356 [~~Table 2~~ Table 3] to agricultural land, forest, a public contact site, or a reclamation site if any of the cumulative pollutant loading rates in 9VAC25-32-356 [~~Table 2~~ Table 3] has been reached.

D. No person shall apply domestic septage to agricultural land, forest, or a reclamation site during a 365-day period if the annual application rate in 9VAC25-32-356 [~~C~~ D] has been reached during that period.

E. The person who prepares bulk biosolids that is applied to agricultural land, forest, a public contact site, or a reclamation site shall provide the person who applies the bulk biosolids written notification of the concentration of total nitrogen [~~as N on a dry weight basis~~] and phosphorus (as N and P on a dry weight basis)] in the bulk biosolids.

F. Before bulk biosolids subject to the cumulative pollutant loading rates in 9VAC25-32-356 [~~Table 2~~ Table 3] is applied to the land, the person who proposes to apply the bulk biosolids shall contact the department to determine whether bulk biosolids subject to the cumulative pollutant loading rates in 9VAC25-32-356 [~~Table 2~~ Table 3] has been applied to the site since July 20, 1993.

1. If bulk biosolids subject to the cumulative pollutant loading rates in 9VAC25-32-356 [~~Table 2~~ Table 3] has not been applied to the site since July 20, 1993, the cumulative amount of each pollutant listed in 9VAC25-32-356 [~~Table 2~~ Table 3] may be applied to the site in accordance with 9VAC25-32-356 [~~A-2 a~~ B 2 a].

2. If bulk biosolids subject to the cumulative pollutant loading rates in 9VAC25-32-356 [~~Table 2~~ Table 3] has been applied to the site since July 20, 1993, and the cumulative amount of each pollutant applied to the site in the bulk biosolids since that date is known, the cumulative amount of each pollutant applied to the site shall be used to determine the additional amount of each pollutant that can be applied to the site in accordance with 9VAC25-32-356 [~~A-2 a~~ B 2 a].

3. If bulk biosolids subject to the cumulative pollutant loading rates in 9VAC25-32-356 [~~Table 2~~ Table 3] has been applied to the site since July 20, 1993, and the cumulative amount of each pollutant applied to the site in the bulk biosolids since that date is not known, an

Regulations

additional amount of each pollutant shall not be applied to the site in accordance with 9VAC25-32-356 [~~A-2-a B 2 a~~].

G. When a person who prepares bulk biosolids provides the bulk biosolids to a person who applies the bulk biosolids to the land, the person who prepares the bulk biosolids shall provide the person who applies the biosolids notice and necessary information to comply with the requirements in this article.

H. When a person who prepares biosolids provides the biosolids to another person who prepares the biosolids, the person who provides the biosolids shall provide the person who receives the biosolids notice and necessary information to comply with the requirements in this article.

I. The person who applies bulk biosolids to the land shall provide the owner or lease holder of the land on which the bulk biosolids is applied notice and necessary information to comply with the requirements in this article.

J. Any person who prepares bulk biosolids in another state that is applied to land in Virginia shall provide written notice to the department prior to the initial application of bulk biosolids to the land application site by the applier. The notice shall include:

1. The location, by either street address or latitude and longitude, of each land application site;
2. The approximate time period bulk biosolids will be applied to the site;
3. The name, address, telephone number, and National Pollutant Discharge Elimination System permit number (if appropriate) for the person who prepares the bulk biosolids; and,
4. The name, address, telephone number, and National (or Virginia) Pollutant Discharge Elimination System permit number (if appropriate) for the person who will apply the bulk biosolids.

K. Any person who applies bulk biosolids subject to the cumulative pollutant loading rates in 9VAC25-32-356 [~~Table 2 Table 3~~] to the land shall provide written notice, prior to the initial application of bulk biosolids to the land application site by the applier, to the department and the department shall retain and provide access to the notice. The notice shall include:

1. The location, by either street address or latitude and longitude, of the land application site; and
2. The name, address, telephone number, and Virginia Pollution Abatement permit number (if appropriate) of the person who will apply the bulk biosolids.

9VAC25-32-315. Additional and more stringent requirements.

A. On a case-by-case basis, the board may impose requirements for the use of biosolids or the disposal of sewage sludge in addition to or more stringent than the

requirements in this part when necessary to protect human health and the environment from any adverse effect of a pollutant in the biosolids or sewage sludge.

B. Nothing in this part precludes [the authority of] another state agency [~~with responsibility for regulating biosolids or sewage sludge or any,~~] political subdivision of Virginia [,] or an interstate agency [~~from imposing requirements for the use of biosolids or disposal of sewage sludge more stringent than the requirements in this part or from imposing additional requirements for~~ with respect to] the use of biosolids or disposal of sewage sludge.

C. For biosolids land application where, because of site specific conditions, including soil type, identified during the permit application review process, the department determines that special requirements are necessary to protect the environment or the health, safety, or welfare of persons residing in the vicinity of a proposed land application site, the department may incorporate in the permit at the time it is issued reasonable special conditions regarding [~~buffering setback distances~~], transportation routes, slope, material source, methods of handling and application, and time of day restrictions exceeding those required by this regulation. The permit applicant shall have at least 14 days in which to review and respond to the proposed conditions.

9VAC25-32-317. Exclusions.

A. Treatment processes. This part does not establish requirements for processes to treat domestic sewage or for processes used to treat sewage sludge prior to final use or disposal, except as provided in 9VAC25-32-675 and 9VAC25-32-685.

B. Selection of a use or a disposal practice. This part does not [~~require the selection of a~~ dictate the selection of a specific] biosolids use or sewage sludge disposal practice [by the owner of the wastewater treatment works]; [~~The determination of the manner in which biosolids is used or sewage sludge is disposed is a local determination.~~]

C. Incineration of sewage sludge. This part does not establish requirements for sewage sludge fired in a sewage sludge incinerator or co-fired in an incinerator with other wastes or for the incinerator in which sewage sludge or other waste are co-fired.

D. Hazardous sewage sludge. This part does not establish requirements for the use or disposal of sewage sludge determined to be hazardous in accordance with 40 CFR Part 261 (2000) or the Code of Virginia.

E. Sewage sludge with high PCB concentration. This part does not establish requirements for the use or disposal of sewage sludge with a concentration of polychlorinated biphenyls (PCBs) equal to or greater than 50 milligrams per kilogram of total solids (dry weight basis).

F. Incinerator ash. This part does not establish requirements for the use or disposal of ash generated during the firing of sewage sludge in a sewage sludge incinerator.

G. Grit and screenings. This part does not establish requirements for the use or disposal of grit (e.g., sand, gravel, cinders, or other materials with a high specific gravity) or screenings (e.g., relatively large materials such as rags) generated during preliminary treatment of domestic sewage in a treatment works.

9VAC25-32-320. Local enforcement of the regulation.

A. In the event of a dispute concerning the existence of a violation between a permittee and a locality that has adopted a local ordinance for testing and monitoring of the land application of sewage sludge and a permittee concerning the existence of a violation biosolids, the activity alleged to be in violation shall be halted pending a determination by the director. ~~The decision of the director shall be final and binding unless reversed on judicial appeal pursuant to § 2.2-4026 of the Code of Virginia. If the activity is not halted, the director may seek an injunction compelling the halting of the activity, from a court having jurisdiction.~~

B. Upon determination by the director that there has been a violation of § 62.1-44.19:3, 62.1-44.19:3.1 or 62.1-44.19:3.3 of the Code of Virginia, or of any regulation promulgated under those sections, and that such violation poses an imminent threat to public health, safety or welfare, the department shall commence appropriate action to abate the violation and immediately notify the chief administrative officer of any locality potentially affected by the violation.

C. Local governments shall promptly notify the department of all results from the testing and monitoring of the land application of ~~sewage sludge~~ biosolids performed by persons employed by local governments and any violation of § 62.1-44.19:3, 62.1-44.19:3.1 or 62.1-44.19:3.3 of the Code of Virginia.

D. Local governments receiving complaints concerning land application of biosolids shall notify the department and the permit holder within 24 hours of receiving the complaint.

9VAC25-32-330. Variances.

A. The board may grant a variance to a procedural, design, or operational regulation by following the appropriate procedures set forth in this section.

B. Requirements for a variance. The board may grant a variance if it finds that the hardship imposed ~~(may be economic)~~ outweighs the benefits that may be received by the public and that the granting of such variance does not subject the public to unreasonable health risks or environmental pollution.

C. Application for a variance. Any owner may apply in writing for a variance. The application ~~should~~ shall be ~~sent~~ submitted to the appropriate regional office for evaluation. The application shall include:

1. A citation of the regulation from which a variance is requested.
2. The nature and duration of variance requested.

3. A statement of the hardship to the owner and the anticipated impacts to the public health and welfare if a variance were granted.

4. Suggested conditions that might be imposed on the granting of a variance that would limit its detrimental impact on public health and welfare.

5. Other information, if any, believed to be pertinent by the applicant.

6. Such other information as may be required to make the determination in accordance with subsection B of this section.

D. Consideration of a variance.

1. The board shall act on any variance request submitted pursuant to this subsection within 90 days of receipt of request.

2. In the board's consideration of whether a biosolids use variance should be granted, the board shall consider such factors as the following:

- a. The effect that such a variance would have on the adequate operation of the biosolids use facility, including public nuisance concerns;
- b. The cost and other economic considerations imposed by this requirement; and
- c. The effect that such a variance would have on the protection of the public health or the environment.

E. Disposition of a variance request.

1. The board may grant the variance request and if the board proposes to deny the variance it shall provide the owner an opportunity to an informal [hearing proceeding] as provided in § 2.2-4019 of the Code of Virginia. Following this opportunity for an informal [hearing proceeding] the board may reject any application for a variance by sending a rejection notice to the applicant. The rejection notice shall be in writing and shall state the reasons for the rejection. A rejection notice constitutes a case decision.

2. If the board proposes to grant a variance request submitted pursuant to this regulation, the applicant shall be notified in writing of this decision. Such notice shall identify the variance, the biosolids use facility involved, and shall specify the period of time for which the variance will be effective. Such notice shall provide that the variance will be terminated when the biosolids use facility comes into compliance with the applicable regulation and may be terminated upon a finding by the board that the biosolids use facility has failed to comply with any requirements or schedules issued in conjunction with the variance. The effective date of the variance shall be 15 days following its issuance.

F. Posting of variances. All variances granted for the design or operation of biosolids use facility are nontransferable. Any

Regulations

requirements of the variance shall become part of the permit for biosolids use subsequently granted by the board.

9VAC25-32-340. Permits. (Repealed.)

~~No owner shall cause or allow any land application, marketing or distribution of biosolids except in compliance with a permit issued by the board that authorizes these activities. Application for a permit shall be in accordance with 9VAC25 32 60. Information for the permit application is to be provided by completion and submission of the appropriate application forms and applicable sections in Article 4 (9VAC25 32 670 et seq.) of this part to the appropriate regional office. Applications can be obtained from any regional office.~~

~~A separate biosolids use permit shall be issued for each political jurisdiction (county or city) where land application is to be undertaken.~~

9VAC25-32-355. Biosolids Use Regulation Advisory Committee. (Repealed.)

~~A. The department shall appoint a committee to advise the department on issues related to implementation and administration of this part. Advisory committee membership should include representatives of large size and small size communities and industries and their consultants. The advisory committee shall contain a maximum of 25 members.~~

~~B. The committee members shall be selected from organizations such as:~~

- ~~1. Virginia Association of Counties (VACO) and a representative, such as a local monitor, of a county with sites permitted for land application of biosolids in accordance with this regulation;~~
- ~~2. Virginia Municipal League (VML), the Association of Municipal Wastewater Agencies (VAMWA), and the owners of medium and small flow treatment works;~~
- ~~3. Virginia professional societies (i.e., engineers and soil scientists) and regional wastewater organizations such as the Virginia Water Environment Association;~~
- ~~4. Biosolids consultants and contractors;~~
- ~~5. State university and college faculties;~~
- ~~6. Agricultural industry, the Virginia Farm Bureau and farmers with land permitted in accordance with this regulation;~~
- ~~7. Medical professionals and "at large" citizens; and~~
- ~~8. State agencies such as the Department of Conservation and Recreation, the Department of Health, and the Department of Agriculture and Consumer Services.~~

~~C. Consideration shall also be given to appropriate citizens who are not members of these organizations and other interested parties and groups such as citizens' conservation organizations.~~

~~D. Each committee member may designate an alternate to serve when necessary.~~

~~E. The function of the committee will be to meet, discuss issues, and make recommendations to the department concerning the regulations and standards contained in this part and other policies, procedures and programs for regulating biosolids use and associated fees. The committee's meetings will be advertised and open to the public, and comments and recommendations from the public will be received.~~

Article 2

Operational and Monitoring Requirements

9VAC25-32-356. Pollutant [monitoring and] limits.

A. [Bulk biosolids or biosolids sold or given away in a bag or other container shall be monitored for the parameters identified in Table 1 of this section:

<u>TABLE 1</u> <u>PARAMETERS for BIOSOLIDS ANALYSIS⁽¹⁾</u>
<u>Pollutant</u>
<u>Percent solids (%)</u>
<u>Volatile solids (%)</u>
<u>pH (standard units)</u>
<u>Total Kjeldahl nitrogen (%)</u>
<u>Ammonia nitrogen (%)</u>
<u>Nitrates (mg/kg)</u>
<u>Total phosphorus (%)</u>
<u>Total potassium (%)</u>
<u>Alkalinity as CaCO₃ (mg/kg)⁽²⁾</u>
<u>Arsenic (mg/kg)</u>
<u>Cadmium (mg/kg)</u>
<u>Copper (mg/kg)</u>
<u>Lead (mg/kg)</u>
<u>Mercury (mg/kg)</u>
<u>Molybdenum (mg/kg)</u>
<u>Nickel (mg/kg)</u>
<u>Selenium (mg/kg)</u>
<u>Zinc (mg/kg)</u>
⁽¹⁾ Values reported on a dry weight basis unless indicated.
⁽²⁾ Lime treated biosolids (10% or more lime by weight) shall be analyzed for percent CaCO ₃ .

B.] Biosolids [pollutant limits],

1. Bulk biosolids or biosolids sold or given away in a bag or other container shall not be applied to the land if the

concentration of any pollutant in the biosolids exceeds the ceiling concentration for the pollutant in [~~Table 1~~ Table 2] of this section.

2. If bulk biosolids is applied to agricultural land, forest, a public contact site, or a reclamation site, either:

a. The cumulative loading rate for each pollutant shall not exceed the cumulative pollutant loading rate for the pollutant in [~~Table 2~~ Table 3] of this section; or

b. The concentration of each pollutant in the biosolids shall not exceed the concentration for the pollutant in [~~Table 3~~ Table 4] of this section.

3. If bulk biosolids is applied to a lawn or a home garden, the concentration of each pollutant in the biosolids shall not exceed the concentration for the pollutant in [~~Table 3~~ Table 4] of this section.

4. If biosolids is sold or given away in a bag or other container for application to the land, either:

a. The concentration of each pollutant in the biosolids shall not exceed the concentration for the pollutant in [~~Table 3~~ Table 4] of this section; or

b. The product of the concentration of each pollutant in the biosolids and the annual whole sludge application rate for the biosolids shall not cause the annual pollutant loading rate for the pollutant in [~~Table 4~~ Table 5] of this section to be exceeded. The procedure used to determine the annual whole sludge application rate is presented in subsection D of this section.

[~~B. C.~~] Pollutant concentrations and loading rates - biosolids.

[TABLE 1 TABLE 2] CEILING CONCENTRATIONS	
Pollutant	Ceiling Concentration (milligrams per kilogram)*
Arsenic	75
Cadmium	85
Copper	4,300
Lead	840
Mercury	57
Molybdenum [⁽⁺⁾]	75
Nickel	420
Selenium	100
Zinc	7,500
*Dry weight basis [⁽⁺⁾ Biosolids with a molybdenum concentration greater than 40 mg/kg shall not be applied to land used for livestock grazing.]	

[TABLE 2 TABLE 3] CUMULATIVE POLLUTANT LOADING RATES ⁽¹⁾		
Pollutant	Cumulative Pollutant Loading Rate	
	(kilograms per hectare)	(pounds per acre)
Arsenic ⁽²⁾	41	36
Cadmium	39	35
Copper	1,500	1,340
Lead	300	270
Mercury	17	16
Molybdenum ⁽²⁾		
Nickel	420	375
Selenium	100	89
Zinc	2,800	2,500
Notes: ⁽¹⁾ Such total applications to be made on soils with the biosolids/soil mixture pH adjusted to 6.0 or greater if the biosolids cadmium content is greater than or equal to 21 mg/kg. The maximum cumulative application rate is limited for all ranges of cation exchange capacity due to soil background pH in Virginia of less than 6.5 and lack of regulatory controls of soil pH adjustment after biosolids application ceases. ⁽²⁾ The maximum cumulative application is currently under study by USEPA. [Research suggests that for Molybdenum a cumulative pollutant loading rate below 40 kg/hectare may be appropriate to reduce the risk of copper deficiency in grazing animals.]		

[TABLE 3 TABLE 4] POLLUTANT CONCENTRATIONS	
Pollutant	Monthly Average Concentration (milligrams per kilogram)*
Arsenic	41
Cadmium	39
Copper	1,500
Lead	300
Mercury	17
Molybdenum ⁽¹⁾	
Nickel	420

Regulations

<u>Selenium</u>	<u>100</u>
<u>Zinc</u>	<u>2,800</u>
*Dry weight basis Note: ⁽¹⁾ The monthly average concentration is currently under study by USEPA. [Research suggests that a monthly average Molybdenum concentration below 40 mg/kg may be appropriate to reduce the risk of copper deficiency in grazing animals.]	

[<u>TABLE 4 TABLE 5</u>] ANNUAL POLLUTANT LOADING RATES [⁽¹⁾]		
Pollutant	Annual Pollutant Loading Rate (per 365-day period)	
	(kilograms per hectare)	(pounds per acre)
<u>Arsenic</u> [⁽²⁾]	<u>2.0</u>	<u>1.8</u>
<u>Cadmium</u>	<u>1.9</u>	<u>1.7</u>
<u>Copper</u>	<u>75</u>	<u>67</u>
<u>Lead</u>	<u>15</u>	<u>13</u>
<u>Mercury</u>	<u>0.85</u>	<u>0.76</u>
<u>Molybdenum</u> ⁽²⁾		
<u>Nickel</u>	<u>21</u>	<u>19</u>
<u>Selenium</u>	<u>5.0</u>	<u>4.6</u>
<u>Zinc</u>	<u>140</u>	<u>125</u>
Notes: ⁽¹⁾ Such total applications to be made on soils with the biosolids/soil mixture pH adjusted to 6.0 or greater if the biosolids cadmium content is greater than or equal to 21 mg/kg. The maximum cumulative application rate is limited for all ranges of cation exchange capacity due to soil background pH in Virginia of less than 6.5 and lack of regulatory controls of soil pH adjustment after biosolids application ceases. ⁽²⁾ The maximum cumulative application is currently under study by USEPA.		

[C. D.] Procedures to determine the annual whole sludge application rate (AWSAR) for biosolids. Subdivision [A 4 b B 4 b] of this section requires that the product of the concentration for each pollutant listed in Table 4 of this section in biosolids sold or given away in a bag or other container for application to the land and the AWSAR for the biosolids not cause the annual pollutant loading rate for the pollutant in [Table 4 Table 5] to be exceeded. This subsection contains that procedure used to determine the

AWSAR for a biosolids that does not cause the annual pollutant loading rates (APLR) in [Table 4 Table 5] of this section to be exceeded.

1. The relationship between the APLR for a pollutant and the AWSAR for a biosolids is shown in equation (1):

EQUATION (1)
$APLR = C \times AWSAR \times 0.001$
APLR = Annual pollutant loading rate in kilograms per hectare per 365-day period
C = Pollutant concentration in milligrams per kilogram of total solids (dry weight basis)
AWSAR = Annual whole sludge application rate in metric tons per hectare per 365-day period (dry weight basis)
0.001 = A conversion factor

2. To determine the AWSAR, equation (1) is rearranged into equation (2):

EQUATION (2)
$AWSAR = APLR / (C \times 0.001)$
AWSAR = Annual whole sludge application rate in metric tons per hectare per 365-day period (dry weight basis)
APLR = Annual pollutant loading rate in kilograms per hectare per 365-day period
C = Pollutant concentration in milligrams per kilogram of total solids (dry weight basis)
0.001 = A conversion factor

3. The procedure used to determine the AWSAR for a biosolids is presented below:

- a. Analyze a sample of the biosolids to determine the concentration for each of the pollutants listed in Table 4 of this section in the biosolids.
- b. Using the pollutant concentrations from subdivision 3 a of this subsection and the APLRs from [Table 4 Table 5] of this section, calculate an AWSAR for each pollutant using Equation (2) above.
- c. The AWSAR for the biosolids is the lowest AWSAR calculated in subdivision 3 b of this subsection.

9VAC25-32-357. Operational standards, pathogens, and vector attraction reduction.

- A. Biosolids shall be monitored to verify that the selected pathogen reduction treatment classification and vector attraction reduction method requirements have been met.
- B. Pathogens – biosolids.

1. The Class A pathogen requirements in 9VAC25-32-675 A or the Class B pathogen requirements and site restrictions in 9VAC25-32-675 B shall be met when bulk biosolids is applied to agricultural land, forest, a public contact site, or a reclamation site.

2. The Class A pathogen requirements in 9VAC25-32-675 A shall be met when bulk biosolids is applied to a lawn or a home garden.

3. The Class A pathogen requirements in 9VAC25-32-675 A shall be met when biosolids is sold or given away in a bag or other container for application to the land.

C. Pathogens – domestic septage. The requirements in [~~either~~] 9VAC25-32-675 C [~~1 or C 2~~] shall be met when domestic septage is applied to agricultural land, forest, or a reclamation site.

D. Vector attraction reduction – biosolids.

1. One of the vector attraction reduction requirements in 9VAC25-32-685 B 1 through B 10 shall be met when bulk biosolids is applied to agricultural land, forest, a public contact site, or a reclamation site.

2. One of the vector attraction reduction requirements in 9VAC25-32-685 B 1 through B 8 shall be met when bulk biosolids is applied to a lawn or a home garden.

3. One of the vector attraction reduction requirements in 9VAC25-32-685 B 1 through B 8 shall be met when biosolids is sold or given away in a bag or other container for application to the land.

E. Vector attraction reduction – domestic septage. The vector attraction reduction requirements in 9VAC25-32-685 B 9, B 10, or B 12 shall be met when domestic septage is applied to agricultural land, forest, or a reclamation site.

F. Additional operational control information may be required on an individual basis by the department.

9VAC25-32-358. Frequency of monitoring.

A. Biosolids.

1. The frequency of monitoring for the pollutants listed in Tables 1 through [4 5] of 9VAC25-32-356; the pathogen density requirements in 9VAC25-32-675 A and B 2 through B 4; and the vector attraction reduction requirements in 9VAC25-32-685 B 1 through B 4, B 7, and B 8 shall be the frequency in Table 1 of this section.

TABLE 1 FREQUENCY OF MONITORING – LAND APPLICATION	
Amount of biosolids ⁽¹⁾ (metric tons per 365-day period)	Frequency ⁽²⁾
Greater than zero but less than 290	Once per year

Equal to or greater than 290 but less than 1,500	Once per quarter (four times per year)
Equal to or greater than 1,500 but less than 15,000	Once per 60 days (six times per year)
Equal to or greater than 15,000	Once per month (12 times per year)
Note ⁽¹⁾ : Either the amount of bulk biosolids applied to the land or the amount of biosolids received by a person who prepares biosolids that is sold or given away in a bag or other container for application to the land (dry weight basis).	
Note ⁽²⁾ : Sampling shall be conducted at approximately equal intervals at the listed frequencies. Biosolids programs that store biosolids and land apply only during discrete events throughout the year shall schedule sampling events to coincide with application periods. The department may require increased monitoring frequencies, if necessary, to adequately define any significant variability in biosolids quality.	

2. After the biosolids has been monitored for two years at the frequency in Table 1 of this section, the board may reduce the frequency of monitoring for pollutant concentrations and for the pathogen density requirements in 9VAC25-32-675 A 5 b and c. [~~In no case shall the frequency be reduced to less than once per year in any year that biosolids are applied to land.~~]

B. Domestic septage. If [~~either the pathogen requirements in 9VAC25-32-675 C 2 or~~] the vector attraction reduction requirements in 9VAC25-32-685 B 12 are met when domestic septage is applied to agricultural land, forest, or a reclamation site, each container of domestic septage applied to the land shall be monitored for compliance with those requirements.

9VAC25-32-359. Recordkeeping.

A. Biosolids.

1. If the pollutant concentrations in [~~Table 3~~ Table 4] of 9VAC25-32-356, the Class A pathogen requirements in 9VAC25-32-675 A, and the vector attraction reduction requirements in either 9VAC25-32-685 B 9 or B 10 are met when bulk biosolids is applied to agricultural land, forest, a public contact site, or a reclamation site:

a. The person who prepares the bulk biosolids shall develop the following information and shall retain the information for five years:

(1) The concentration of each pollutant listed in [~~Table 3~~ Table 4] of 9VAC25-32-356 in the bulk biosolids;

(2) The following certification statement:

Regulations

"I certify, under penalty of law, that the information that will be used to determine compliance with the pathogen requirements in 9VAC25-32-675 A was prepared under my direction and supervision in accordance with the system designed to ensure that qualified personnel properly gather and evaluate this information. I am aware that there are significant penalties for false certification including the possibility of fine and imprisonment."; and
(3) A description of how the pathogen requirements in 9VAC25-32-675 A are met.

b. The person who applies the bulk biosolids shall develop the following information and shall retain the information for five years:

(1) The following certification statement:

"I certify, under penalty of law, that the information that will be used to determine compliance with the management practices in 9VAC25-32-560 and the vector attraction reduction requirement in (insert either 9VAC25-32-685 B 9 or B 10) was prepared under my direction and supervision in accordance with the system designed to ensure that qualified personnel properly gather and evaluate this information. I am aware that there are significant penalties for false certification including fine and imprisonment."; and

(2) A description of how the management practices in 9VAC25-32-560 are met for each site on which bulk biosolids is applied; and

(3) A description of how the vector attraction reduction requirements in either 9VAC25-32-685 B 9 or B 10 are met for each site on which bulk biosolids is applied.

2. If the pollutant concentrations in 9VAC25-32-356 [~~Table 3~~ Table 4] and the Class B pathogen requirements in 9VAC25-32-675 B are met when bulk biosolids is applied to agricultural land, forest, a public contact site, or a reclamation site:

a. The person who prepares the bulk biosolids shall develop the following information and shall retain the information for five years:

(1) The concentration of each pollutant listed in [~~Table 3~~ Table 4] of 9VAC25-32-356 in the bulk biosolids;

(2) The following certification statement:

"I certify, under penalty of law, that the information that will be used to determine compliance with the Class B pathogen requirements in 9VAC25-32-675 B and the vector attraction reduction requirement in (insert one of the vector attraction reduction requirements in 9VAC25-32-685 B 1 through B 8, if one of those requirements is met) was prepared under my direction and supervision in accordance with the system designed to ensure that qualified personnel properly gather and evaluate this information. I am aware that there are significant penalties for false certification, including the possibility of fine and imprisonment."; and

(3) A description of how the Class B pathogen requirements in 9VAC25-32-675 B are met; and

(4) When one of the vector attraction reduction requirements in 9VAC25-32-685 B 1 through B 8 is met, a description of how the vector attraction reduction requirement is met.

b. The person who applies the bulk biosolids shall develop the following information and shall retain the information for five years:

(1) The following certification statement:

"I certify, under penalty of law, that the information that will be used to determine compliance with the management practices in 9VAC25-32-560, the site restrictions in 9VAC25-32-675 B 5, and the vector attraction reduction requirements in (insert either 9VAC25-32-685 B 9 or B 10, if one of those requirements is met) was prepared for each site on which bulk biosolids is applied under my direction and supervision in accordance with the system designed to ensure that qualified personnel properly gather and evaluate this information. I am aware that there are significant penalties for false certification including the possibility of fine and imprisonment.";

(2) A description of how the management practices in 9VAC25-32-560 are met on each site on which bulk biosolids is applied;

(3) A description of how the site restrictions in 9VAC25-32-675 B 5 are met for each site on which bulk biosolids is applied;

(4) When the vector attraction reduction requirement in either 9VAC25-32-685 B 9 or B 10 is met, a description of how the vector attraction reduction requirement is met; and

(5) The date bulk biosolids is applied to each site.

3. If the requirements in 9VAC25-32-356 [~~A-2~~ B 2] are met when bulk biosolids is applied to agricultural land, forest, a public contact site, or a reclamation site:

a. The person who prepares the bulk biosolids shall develop the following information and shall retain the information for five years:

(1) The concentration of each pollutant listed in [~~Table 1~~ Table 2] of 9VAC25-32-356 in the bulk biosolids;

(2) The following certification statement:

"I certify, under penalty of law, that the information that will be used to determine compliance with the pathogen requirements in (insert either 9VAC25-32-675 A or B and the vector attraction reduction requirement in (insert one of the vector attraction reduction requirements in 9VAC25-32-685 B 1 through B 8, if one of those requirements is met)) was prepared under my direction and supervision in accordance with the system designed to ensure that qualified personnel properly gather and

evaluate this information. I am aware that there are significant penalties for false certification including the possibility of fines and imprisonment.";

(3) A description of how the pathogen requirements in either 9VAC25-32-675 A or B are met; and,

(4) When one of the vector attraction requirements in 9VAC25-32-685 B 1 through B 8 is met, a description of how the vector attraction reduction requirement is met.

b. The person who applies the bulk biosolids shall develop the following information, retain the information in subdivisions A 3 b (1) through A 3 b (7) indefinitely, and retain the information in subdivisions A 3 b (8) through A 3 b (13) for five years:

(1) The location, by either street address or latitude and longitude, of each site on which bulk biosolids is applied;

(2) The number of hectares in each site on which bulk biosolids is applied;

(3) The date bulk biosolids is applied to each site;

(4) The cumulative amount of each pollutant (i.e., kilograms) listed in [~~Table 2~~ Table 3] of 9VAC25-32-356 in the bulk biosolids applied to each site, including the amount in 9VAC25-32-313 F 2 c;

(5) The amount of biosolids (i.e., [dry] metric tons) applied to each site;

(6) The following certification statement:

"I certify, under penalty of law, that the information that will be used to determine compliance with the requirements to obtain information in 9VAC25-32-313 F 2 was prepared for each [sites site] on which bulk biosolids is applied under my direction and supervision in accordance with the system designed to ensure that qualified personnel properly gather and evaluate this information. I am aware that there are significant penalties for false certification including fine and imprisonment.";

(7) A description of how the requirements to obtain information in 9VAC25-32-313 F 2 are met;

(8) The following certification statement:

"I certify, under penalty of law, that the information that will be used to determine compliance with the management practices in 9VAC25-32-313 B and 9VAC25-32-560 was prepared for each site on which bulk biosolids is applied under my direction and supervision in accordance with the system designed to ensure that qualified personnel properly gather and evaluate this information. I am aware that there are significant penalties for false certification including fine and imprisonment.";

(9) A description of how the management practices in 9VAC25-32-560 are met for each site on which bulk biosolids is applied;

(10) The following certification statement when the bulk biosolids meet the Class B pathogen requirements in 9VAC25-32-675 B:

"I certify, under penalty of law, that the information that will be used to determine compliance with the site restrictions in 9VAC25-32-675 B 5 was prepared under my direction and supervision in accordance with the system designed to ensure that qualified personnel properly gather and evaluate this information. I am aware that there are significant penalties for false certification including fines and imprisonment.";

(11) A description of how the site restrictions in 9VAC25-32-675 B 5 are met for each site on which Class B bulk biosolids is applied;

(12) The following certification statement when the vector attraction reduction requirement in either 9VAC25-32-685 B 9 or B 10 is met:

"I certify, under penalty of law, that the information that will be used to determine compliance with the vector attraction reduction requirement in (insert either 9VAC25-32-685 B 9 or B 10) was prepared under my direction and supervision in accordance with the system designed to ensure that qualified personnel properly gather and evaluate this information. I am aware that there are significant penalties for false certification including the possibility of fine and imprisonment."; and

(13) If the vector attraction reduction requirements in either 9VAC25-32-685 B 9 or B 10 are met, a description of how the requirements are met.

B. Domestic septage. When domestic septage is applied to agricultural land, forest, or a reclamation site, the person who applies the domestic septage shall develop the following information and shall retain the information for five years:

1. The location, by either street address or latitude and longitude, of each site on which domestic septage is applied;

2. The number of acres in each site on which domestic septage is applied;

3. The date domestic septage is applied to each site;

4. The nitrogen [and phosphorus] requirement for the crop or vegetation grown on each site during the 365-day period;

5. The rate, in gallons per acre per 365-day period, at which domestic septage is applied to each site;

6. The following certification statement:

"I certify, under penalty of law, that the information that will be used to determine compliance with the pathogen requirements in (insert either 9VAC25-32-675 C 1 or C 2) and the vector attraction reduction requirements in (insert 9VAC25-32-685 B 9, B 10, or B 12) was prepared under my direction and supervision in accordance with the system designed to ensure that qualified personnel properly

Regulations

gather and evaluate this information. I am aware that there are significant penalties for false certification including the possibility of fine and imprisonment.";

7. A description of how the pathogen requirements in either 9VAC25-32-675 C 1 or C 2 are met; and

8. A description of how the vector attraction reduction requirements in 9VAC25-32-685 B 9; B 10 and B 12 are met.

Article 2

Operational and Monitoring Requirements

9VAC25-32-360. Monitoring; records; reporting. Reporting.

The board may require the owner or operator of any facility to install, use, and maintain monitoring equipment for internal testing of biosolids quality, to identify and determine the causes of operational problems and to determine the necessary corrective actions to correct such problems. If required, test results shall be recorded, compiled, and reported to the department.

A. An activity report shall be submitted (electronically or postmarked) to the department by the 15th day of [~~the~~ each] month [for land application activity that occurred in the previous calendar month,] unless another date is specified in the permit in accordance with 9VAC25-32-80 I 4 [; following any month in which land application occurs]. The report shall indicate those sites where land application activities took place during the previous month. [If no land application occurs under a permit during the calendar month, a report shall be submitted stating that no land application occurred.]

B. A report shall be submitted to the department annually on February 19 of each year for the previous calendar year's activity. The report shall include at a minimum:

1. The information in 9VAC25-32-359 A, except the information in 9VAC25-32-359 A 1 b, A 2 b and A 3 b, for the appropriate requirements; and

2. The information in 9VAC25-32-359 A 3 b (1) through (7) when 90% or more of any of the cumulative pollutant loading rates in [~~Table 2~~ Table 3] of 9VAC25-32-356 is reached at a land application site.

[~~C. Biosolids application rates shall be calculated using the results from sampling and analysis completed during the most recent 12 months of monitoring. For proposed treatment works, rates may be initially based on the biosolids characteristic produced by similar generating facilities.~~

~~D. C.] Reports shall be maintained documenting the required treatment and quality characteristics and the maximum allowable land application loading rates established for biosolids use; in addition, operational monitoring results shall verify that required sludge treatment has achieved the specified levels of pathogen control and vector attraction reductions (9VAC25-32-675 and 9VAC25-32-685). Adequate records on biosolids composition,~~

~~treatment classification, biosolids application rates, and methods of application for each site shall be maintained by the generator and owner.~~

[~~E. D.] The generator and owner shall maintain the records for a minimum period of five years. Sites receiving frequent applications of biosolids that meet or exceed maximum cumulative constituent loadings and dedicated disposal sites should be properly referenced for future land transactions (Sludge Disposal Site Dedication Form).~~

9VAC25-32-370. Minimum biosolids sampling and testing program. (Repealed.)

A. ~~Sampling and testing methods shall conform to current United States Environmental Protection Agency (EPA) guidelines establishing test procedures for analysis of pollutants or other EPA approved methods.~~

B. ~~Either the operation and maintenance manual, sludge management plan, or management practices plan shall contain a specific testing schedule. The testing schedule shall include minimum tests and their frequencies as required to monitor the facility in accordance with the appropriate certificate and the operating permit issued under this regulation.~~

C. ~~The following sampling instructions shall be followed when collecting samples as required by this regulation:~~

1. ~~Raw sewage or sludge samples are to be collected prior to the treatment process unit operations.~~

2. ~~Final treated samples are to be taken at a point following appropriate unit operations in the treatment process. An evaluation of biosolids treatment may require monitoring of fecal coliform levels in the treated sludge.~~

3. ~~Compositing of samples shall be in accordance with the treatment works operation and maintenance manual. Composite samples of sludge shall consist of grab samples taken in accordance with either the operation and maintenance manual or management practices plan, as appropriate. Composite samples shall be representative of the quality and quantity of the biosolids used. Greater frequency of grab sampling may be desirable where abnormal variation in waste strength occurs. Automatic proportional samplers are considered a valid sampling method.~~

9VAC25-32-380. Minimum operational testing and control program. (Repealed.)

A. ~~Sampling and testing methods shall conform to current United States Environmental Protection Agency (EPA) guidelines establishing test procedures for analysis of pollutants or other EPA approved methods.~~

B. ~~The information furnished with either the operation and maintenance manual, sludge management plan, or management practices plan should recommend and describe the control tests and their frequency that should be routinely conducted by the holder of the permit in order to monitor operations and verify the treatment classification achieved (Table 3). All special sampling methods should be identified.~~

Biosolids use site sampling and testing frequencies should be in accordance with the requirements established by the instructions contained in the biosolids use operation and maintenance manual if provided.

C. Additional operational control information may be required on an individual basis by the department.

9VAC25-32-390. Additional monitoring, reporting and recording requirements for land application. (Repealed.)

A. Either the operation and maintenance manual, sludge management plan or management practices plan shall contain a schedule of the required minimum tests necessary to monitor land application operation. Such testing schedule information for land application of biosolids shall contain instructions for recording and reporting. Monitoring of any associated land treatment systems shall be in accordance with the biosolids use operation and maintenance manual if provided.

B. The permit holder shall provide to the department, and to each locality in which it is permitted to land apply biosolids, written evidence of financial responsibility, including both current liability and pollution insurance, or such other evidence of financial responsibility as the board may establish by regulation in an amount not less than \$1 million per occurrence, which shall be available to pay claims for cleanup costs, personal injury, bodily injury and property damage resulting from the transport, storage and land application of biosolids in Virginia. The aggregate amount of financial liability maintained by the permit holder shall be \$1 million for companies with less than \$5 million in annual gross revenue and shall be \$2 million for companies with \$5 million or more in annual gross revenue.

C. Evidence of financial responsibility, which may include liability insurance, meeting the requirements herein shall be maintained by the permit holder at all times that it is authorized to transport, store or land apply biosolids in Virginia. The permit holder shall immediately notify the Department of Health in the event of any lapse or cancellation of such financial resources, including insurance coverage, as required by this section.

9VAC25-32-400. Additional monitoring, reporting and recording requirements for sewage sludge and residual solids management.

Either the operation and maintenance manual, sludge management plan, or management practices plan shall contain a schedule of required minimum tests and their frequency to be conducted for the sewage sludge and biosolids management system and shall also contain necessary information to document sewage sludge and biosolids quality. Such test schedule information should include instructions for recording and reporting. Monitoring, reporting and recording requirements for sewage sludge and biosolids quality control shall be in accordance with the sludge management plan or management practices plan in accordance with 9VAC25-32-500 B. The recordkeeping and reporting requirements for

sewage sludge and biosolids management contained in the treatment works operation and maintenance manual shall apply to all application sites, regardless of size or frequency of application. However, the requirements relative to monitoring, reporting and recording of site specific soils and monitoring, reporting and recording of ground water and surface water are not applicable for any site that meets either of the following criteria:

1. Whenever exceptional quality biosolids are marketed and distributed with a label or identification information that specifies proper quality information and describes how agronomic rates are to be determined. Also, whenever Class I treated biosolids are land applied so that (i) the annual loading rate will not result in annual maximum loading rates in excess of those specified in Table 8; (ii) applied biosolids will meet vector attraction requirements; (iii) the amount of nutrients applied does not exceed the total crop needs or agronomic loading rate; (iv) no additional biosolids are applied for at least five years, or the biosolids are applied to land maintained only as pasture or hay land for five years following the last application of biosolids and the nutrient loading rate does not exceed 70% of the annual total crop needs of the grass or hay cover (Tables A-2 and 11).

2. Whenever the application site area for biosolids processed by Class I or II treatment is no larger than 10 acres and is isolated (2,000 feet or more separation distance) from other sites receiving applications of biosolids within three years of the time biosolids are applied to the identified site and the necessary vector attraction requirements are met.

A. The department may recommend require that specified additional site specific monitoring be performed by the holder of the permit for any biosolids land application practice regardless of frequency of application or size of the application area. Such recommendations will requirements may occur in situations in which [groundwater ground water] contamination, surface runoff, soil toxicity, health hazards or nuisance conditions are identified as an existing problem or documented as a potential problem as a result of biosolids use operations. Requirements of 9VAC 25-32-510 through 9VAC25-32-580 shall apply in full whether or not a monitoring waiver provision is applicable. Additional monitoring may include, but is not limited to, [groundwater groundwater], surface water, crop, and soil monitoring.

B. The board may require the owner or operator of any facility or operation to install, use, and maintain monitoring equipment for internal testing of biosolids quality, to identify and determine the causes of operational problems, and to determine the necessary corrective actions to correct such problems. If this testing is required, test results shall be recorded, compiled, and reported to the department.

C. Additional operational control information may be required on an individual basis by the department.

Regulations

D. The department may require biosolids to be tested for certain toxic organic compounds prior to agricultural use [~~(Table 1 of 9VAC25-32-570)~~]. If performed and validated, these test results shall be utilized to evaluate the maximum allowable annual loading rate for the tested biosolids. If analytical test results verify that biosolids contains levels of organic chemicals exceeding concentration limits incorporated in federal regulations or standards, appropriate restrictions shall be imposed for agricultural use of those biosolids.

E. Additional parameters may be required for screening purposes such as aluminum (mg/kg), water [~~soluble~~ soluble] boron (mg/kg), calcium (mg/kg), manganese (mg/kg), sulfates (mg/kg), and those pollutants for which removal credits are granted.

F. Microbiological testing may be necessary to document the sludge treatment classification (9VAC25-32-675). Microbiological standards shall be verified by the log mean of the analytical results from testing of [~~nine~~ seven] or more samples of the sludge source. Sampling events shall be separated by an appropriate period of time so as to be representative of the random and cyclic variations in sewage characteristics.

~~9VAC25-32-410. Operation and maintenance manuals.~~ ~~[Operations Biosolids] management plan.~~

~~A. General. The general purpose of an operation and maintenance manual is to facilitate operation and maintenance of the biosolids use facilities within permit requirements for both normal conditions and generally anticipated adverse conditions. The manual shall be tailored to the size and type of system being employed. The manual shall be directed toward the operating staff required for the facility. The manual shall be updated as necessary and be made available to the operating staff. The manual should be designed as a reference document, being as brief as possible while presenting the information in a readily accessible manner.~~

~~A. The permit holder shall maintain [~~an operations management plan~~ and implement a Biosolids Management Plan] that shall consist of three components:~~

~~1. The materials, including site booklets, developed and submitted at the time of permit application or permit modification adding a farm to the permit in accordance with 9VAC25-32-60 F;~~

~~2. Nutrient management plan [developed] for each site [, in accordance with 9VAC25-32-560 prior to biosolids application]; and~~

~~3. Operations and maintenance (O&M) manual, developed and submitted to the department within 90 days of the effective date of the permit.~~

~~B. Contents. The manual shall contain the testing and reporting elements required by this regulation. In addition, for information and guidance purposes, the manual should~~

~~contain additional schedules that supplement these required schedules.~~

~~B. [The biosolids management plan and all of its components shall be incorporated as an enforceable part of the permit.~~

~~C. Nutrient management plan:~~

~~1. A nutrient management plan approved by the Department of Conservation and Recreation shall be required for application sites prior to board authorization under specific conditions, including but not limited to:~~

~~a. Sites operated by an owner or lessee of a confined animal feeding operation as defined in subsection A of § 62.1-44.17:1 of the Code of Virginia, or confined poultry feeding operation as defined in subsection A of § 62.1-44.17:1.1 of the Code of Virginia;~~

~~b. Sites where land application more frequently than once every three years at greater than 50% of the annual agronomic rate is proposed;~~

~~c. Mined or disturbed land sites where land application is proposed at greater than agronomic rates; and~~

~~d. Other sites based on site-specific conditions that increase the risk that land application may adversely impact state waters.~~

~~2. Where conditions at the land application site change so that it meets one or more of the specific conditions identified in subdivisions 1 a through d of this subsection, an approved nutrient management plan shall be submitted prior to any future land application at the site.~~

~~3. The nutrient management plan shall be available for review by the department at the land application site during biosolids land application.~~

~~4. Within 30 days after land application at the site has commenced, the permit holder shall provide a copy of the nutrient management plan to the farm operator of the site, the Department of Conservation and Recreation and the chief executive officer or designee for the local government unless they request in writing not to receive the nutrient management plan.~~

~~5. The nutrient management plan must be approved by the Department of Conservation and Recreation prior to land application for application sites where the soil test phosphorus levels exceed the values in Table 1 of this section. For purposes of approval, permittees should submit the nutrient management plan to the Department of Conservation and Recreation at least 30 days prior to the anticipated date of land application to ensure adequate time for the approval process.~~

TABLE 1 SOIL PHOSPHORUS LEVELS REQUIRING NMP APPROVAL	
Region	Soil Test P (ppm)

	<u>VPI & SU Test (Mehlich I)*</u>
<u>Eastern Shore and Lower Coastal Plain</u>	<u>135</u>
<u>Middle and Upper Coastal Plain and Piedmont</u>	<u>136</u>
<u>Ridge and Valley</u>	<u>162</u>

*If results are from another laboratory, the Department of Conservation and Recreation approved conversion factors must be used.

D.] The O&M manual shall include at a minimum:

1. Equipment maintenance and calibration procedures and schedules;
2. Storage facility maintenance procedures and schedules;
3. Sampling schedules for:
 - a. Required monitoring; and
 - b. Operational control testing;
4. Sample collection, preservation, and analysis procedures, including laboratories and methods used; and
5. Instructions for recording and reporting of all monitoring activities.

9VAC25-32-420. Operability.

A. Independently operated essential equipment, or components, of biosolids use facilities and operations, including treatment works, shall be provided with sufficient capacity and routine maintenance resources so that the average quantity of biosolids used may be reliably transported, stored, treated or otherwise managed in accordance with permit requirements. Permit noncompliance shall be prevented in those situations in which the largest component is out of service.

B. The need for spare parts ~~should~~ shall be determined from operational experience; and evaluation of past maintenance requirements, etc. A spare parts inventory may be included in the operation and maintenance manual. ~~The inventory should list the minimum and maximum quantities of the spare parts to be kept on hand, the equipment in which they are used, their storage location, replacement procedures and other pertinent information.~~

C. Sufficient spare parts determined as necessary to ensure continuous operability of essential unit operations and equipment ~~should~~ shall be either located at the treatment works or at readily accessible locations. The minimum quantities of spare parts actually provided shall be in accordance with the operation and maintenance manual.

9VAC25-32-440. Biosolids ~~monitoring/reporting.~~ (Repealed.)

A. ~~Monitoring biosolids quality shall be performed as required for permit compliance. Monitoring frequency shall~~

be sufficient to both reflect the degree of variability, if any, expected in the biosolids quality and the frequency of application. The following guidelines should provide sufficient data for characterizing the quality of biosolids for biosolids programs that land apply continuously throughout the year.

Amount of biosolids ⁽⁴⁾ (metric tons per 365-day period)	Frequency
Greater than zero but less than 290	Once per year
Equal to or greater than 290 but less than 1,500	Once per quarter (four times per year)
Equal to or greater than 1,500 but less than 15,000	Once per 60 days (six times per year)
Equal to or greater than 15,000	Per month (12 times per year)
Note: ⁽⁴⁾ Either the amount of bulk sewage applied to the land or the amount of sewage sludge received by a person who prepares sewage sludge that is sold or given away in a bag or other container for application to the land (dry weight basis).	

~~Note: Sampling shall be conducted at approximately equal intervals at the listed frequencies. Biosolids programs that store biosolids and land apply only during discrete events throughout the year shall schedule sampling events to coincide with application periods. The regulatory agency may require increased monitoring frequencies, if necessary, to adequately define any significant variability in biosolids quality. After two years of monitoring the permittee may request that the monitoring frequency be reduced, but in no case to less than once per year in any year that biosolids are applied to land.~~

~~B. An activity report shall be submitted (postmarked) to the department by the 15th day of the month unless another date is specified in the permit in accordance with 9VAC25-32-80-I 4, following any month in which land application occurs. The report shall indicate those sites where land application activities took place during the previous month.~~

~~C. Biosolids application rates should be based on the annual average sludge quality. The average sludge quality should be established from the results of approved analytical testing of composite samples obtained during the most recent 12 months of monitoring. For proposed treatment works, rates may be initially based on the biosolids characteristic produced by similar generating facilities.~~

~~D. The required treatment and quality characteristics and the maximum allowable land application loading rates shall be established for biosolids use. In addition, operational~~

Regulations

monitoring results shall verify that required sludge treatment has achieved the specified levels of pathogen control and vector attraction reductions (Table 3). Adequate records on sludge composition, treatment classification, sludge application rates and methods of application for each site shall be maintained by the generator and owner. Table 4 shows a sample operating report for documenting the minimum required information. Reporting shall be yearly (postmarked by February 19 for the preceding calendar year) unless otherwise required. The generator and owner shall maintain the records as necessary for a minimum period of five years until further notification by the department. Sites receiving frequent applications of sludge that meet or exceed maximum cumulative constituent loadings and dedicated disposal sites should be properly referenced for future land transactions (see the sample Sludge Disposal Site Dedication Form Table A 1).

9VAC25-32-450. Sampling, analysis [2] and preservation.

A. General. The sampling procedures and protocols used for the national sewage sludge survey (EPA Office of Water Regulations and Standards, March 1988) or validated equivalent methods will be approved by the board through issuance of a permit for biosolids use. Composite samples are better than single grab samples because they define representative "average" levels of sludge characteristics. A large open container such as a one to two gallon capacity bucket will normally be necessary to obtain complete grab samples of sludge flows. The volume or weight of grab samples should be adjusted so as to represent approximately equal volumes or weights of the sludge volume or mass being sampled. These adjusted grab samples can then be added to form a composite sample.

A. Representative samples of biosolids that is applied to the land or placed on a surface disposal site shall be collected and analyzed.

1. Raw sewage or sludge samples are to be collected prior to the treatment process unit operations.
2. Final treated samples are to be taken at a point following appropriate unit operations in the treatment process. An evaluation of biosolids treatment may require monitoring of fecal coliform levels in treated biosolids.
3. Composite samples shall be collected in accordance with the treatment works operation and maintenance manual.

B. Liquid sludge biosolids. In the case of digesters and liquid storage holding tanks, a representative sample shall be composed of at least four grab samples obtained during daily operations at the facility or land application site. Samples of liquid biosolids obtained under pressure or vacuum should be obtained shortly after the beginning, during and at the end of the time period that the biosolids are produced at the sampling point.

C. Biosolids storage facilities. Equal volumes of biosolids ~~should~~ shall be withdrawn from random locations across the

width and throughout the length of the storage facility at the surface, mid-depth and near the bottom of the lagoon at each grab sample location. These grab samples ~~should~~ shall be added to form a composite mix. A range of the ~~recommended~~ minimum number of grab samples that should be obtained from various sizes of ~~sludge lagoons~~ biosolids storage facilities in order to obtain a representative composite sample is presented in Table 1 of this section:

<u>Lagoon Surface Area (Acres)</u>	<u>Minimum Number of Grab Samples</u>	
	<u>Depth less than 4 feet</u>	<u>Depth greater than 4 feet</u>
<u>1 to 9.99</u>	<u>4 to 5</u>	<u>6 to 8</u>
<u>10 or more</u>	<u>6 to 8</u>	<u>9 to 11</u>

D. Dewatered sludge biosolids. Small, equally sized grab samples of the dewatered sludge stream may be taken at equally spaced intervals over the period of operation of the dewatering unit. Centrifuged sludge biosolids samples may be taken from a belt conveyor or receiving hopper. Filter cake sludge biosolids samples may be taken from a belt conveyor or a portion of the cake may be removed as it leaves the unit. The smaller grab samples should be combined to form a representative composite sample. A composite sample can be obtained over the daily operational period at the land application site.

E. Compost sampling. Composite Collect composite samples are preferred composed of at least three grab samples of 1 kilogram or more so that a representative average level of compost characteristics can be obtained from analytical testing. Although the compost material has been subjected to premixing, some variation in quality may exist and at least three grab samples of one kilogram or more should be taken of each mixture and combined to form a composite sample of that mixture. This mixture should be used for analytical testing or for combination with other composites to obtain a total composite sample representing a fixed period of operation. Compost samples may be taken with a scoop or shovel and placed in flexible bags that can be thoroughly shaken to mix grab samples.

F. Analysis and preservation of samples. In general, sludge samples should be refrigerated at approximately 4°C immediately after collection, which provides adequate preservation for most types of sludge physical and chemical analysis for a period up to seven days. Exact sample analysis and preservation techniques should be submitted in the sludge management plan. Analytical procedures should be updated as needed. Biosolids samples shall be preserved and analyzed in accordance with methods listed in 40 CFR Part 136 (2007) and methods identified in 9VAC25-31-490. Calculation

procedures in the methods shall be used to calculate the percent volatile solids reduction for biosolids. Any other acceptable test procedure not listed in 40 CFR Part 136 (2007) shall be specified in the VPA permit.

9VAC25-32-460. Soils monitoring and reporting.

~~A. Soil should~~ shall be sampled and analyzed prior to ~~sludge biosolids application [to determine site suitability and to provide background data]. After the land application program is underway, it may be necessary to continue monitoring possible changes in the soil characteristics of the application site. [No sample analysis used to determine application rates shall be more than three years old at the time of biosolids land application.]~~ Soil shall be sampled and analyzed in accordance with Table 1 of this section. [Reduced monitoring will usually may apply for typical agricultural utilization projects where biosolids are applied to farmland at or below agronomic rates or on an infrequent basis (see Table 5) (Table 1).] Reduced monitoring may also apply to one time sludge biosolids applications to forest or reclaimed lands. For background analysis, random composite soil samples from the zone of incorporation is required for infrequent applications and frequent applications at less than agronomic rates (total less than 15 dry tons per acre).

TABLE 1
SOIL TEST PARAMETERS FOR LAND APPLICATION SITES¹

Parameter	[Biosolids Application			Storage
	Infrequent ²	Frequent Below Agromic Rates ²	Frequent at Agromic Rates ²	Super-natant ⁴
Soil pH (Std. Units)	⌘	⌘	⌘	⌘
Nitrate nitrogen (ppm) ²			⌘	
Available phosphorus (ppm) ⁵	⌘	⌘	⌘	⌘
Extractable potassium (ppm)	⌘	⌘	⌘	⌘
Extractable sodium (mg/100g)	⌘	⌘	⌘	⌘
Extractable calcium (mg/100g)			⌘	⌘
Extractable magnesium (mg/100g)	⌘		⌘	⌘
Zinc (ppm)	⌘	⌘	⌘	⌘

Manganese (ppm)	⌘	⌘	⌘	
Hydraulic conductivity (cm/sec)				⌘

¹Note: Unless otherwise stated, analyses shall be reported on a dry weight basis (*).

²See 9VAC25-32-560 B 3.

³Only used as a supplemental fertilizer for side-dressing corn.

⁴Liquid biosolids derived from biosolids use facilities.

⁵Available P shall be analyzed using one of the following methods: Mehlich I, Mehlich III, or Bray.

⁶Extractable sodium shall be analyzed only where biosolids known to be high in sodium will be land applied.

Parameter
Soil pH (Std. Units)
Available phosphorus (ppm) ²
Extractable potassium (ppm)
Extractable sodium (mg/100g) ³
Extractable calcium (mg/100g)
Extractable magnesium (mg/100g)
Zinc (ppm)
Manganese (ppm)

¹Note: Unless otherwise stated, analyses shall be reported on a dry weight basis.
²Available P shall be analyzed using one of the following methods: Mehlich I or Mehlich III.
³Extractable sodium shall be analyzed only where biosolids known to be high in sodium will be land applied.]

Generally, one subsample per acre should be taken for application sites of 10 acres or more receiving frequent applications. For frequent land application sites greater than 50 acres, a controlled area of approximately 10 acres in size may be provided that is representative of site loading and soil characteristics. The control area should be sampled through random collection of approximately 20 subsamples taken according to standard agricultural practices. Records of soil analysis must be maintained by the owner and submitted as required.

B. The permit applicant or permit holder may be required to conduct soil testing and analysis of additional parameters, as determined by the department, based on site-specific history or conditions.

C. Samples shall be collected in accordance with § 10.1-104.2 of the Code of Virginia.

9VAC25-32-480. [Groundwater ~~Ground~~ water] monitoring and reporting.

A. Monitoring wells may be required by the board as recommended by the department for land treatment sites, sludge lagoons, or sludge holding biosolids land application sites, or biosolids storage facilities to monitor [groundwater

Regulations

~~ground water~~] quality. The wells should be designed and located to meet specific geologic and hydrologic conditions at each site. Existing wells or springs may be approved for use as monitoring wells if they can be shown to provide a representative sample of groundwater conditions. The monitoring well should be constructed so as to sample the shallowest occurrence of groundwater that can reliably be obtained. The wells must be deep enough to penetrate the water table, and the screened interval must be in the saturated zone. The well construction should include PVC casing and screen with a bottom end plug or cap. The casing joints should be of the threaded, split ring or some other type that does not require adhesive. The screened interval should be backfilled with washed porous media (sand/gravel) and a bentonite or other impermeable seal placed at least two feet above the screen. The remainder of the well may be backfilled with clean native materials. A concrete surface seal should slope away from the well. Locking caps are recommended. Upon well completion, a driller's log shall be submitted to the department.

B. Sampling procedures must assure maintenance of sample integrity. Samples should be collected in clean sample containers and with an uncontaminated sampling device. In order to obtain a representative sample, standing water in the well must be evacuated prior to sampling. At a minimum, at least three times the volume of water standing in the borehole should be removed prior to taking a sample for analysis to assure movement of formation water into the well and eliminate false readings that would be obtained from water that has stratified in the well. Samples may be obtained by pumping, bailing or pressure methods (e.g., Bar Cad samplers). The state does not endorse any one particular method or manufacturer, but each method has advantages and disadvantages that must be considered prior to final selection. Sampling methodology should be submitted for initial review. To obtain sufficient background groundwater quality data, three to six monthly samples should be collected from each observation well prior to placing the land application site or other facility into operation. Sampling should account for seasonal groundwater table fluctuations. Groundwater samples shall be collected and analyzed on a quarterly basis during operation of the site or facility. Table 6 lists typical parameters for groundwater monitoring. Additional test parameters may be required on a case by case basis. If [~~ground water~~ groundwater] monitoring is required, a [~~ground water~~ groundwater] monitoring plan shall be submitted to the department for approval that includes at a minimum:

1. Geologic and hydrologic conditions at the site;
2. Monitoring well design, placement, and construction;
3. Sampling frequency;
4. Sampling procedures, including quality assurance and quality control; and
5. Collection of background samples.

C. Sample analysis and preservation techniques should be in accordance with the latest edition of Standard Methods for the Examination of Water and Wastewater.

TABLE 2
PARAMETERS FOR BIOSOLIDS ANALYSIS⁽¹⁾

A. Suggested minimum

Source of sludge

Type of sludge (lime stabilized, aerobically digested, etc.)

Percent solids (%)

Volatile solids (%)

pH (standard units)

Total kjeldahl nitrogen (%)

Ammonia nitrogen (%)

Nitrates (mg/kg)

Total phosphorus (%)

Total potassium (%)

Alkalinity as CaCO₃ (mg/kg)⁽²⁾

Arsenic (mg/kg)

Cadmium (mg/kg)

Copper (mg/kg)

Lead (mg/kg)

Mercury (mg/kg)

Molybdenum (mg/kg)

Nickel (mg/kg)

Selenium (mg/kg)

Zinc (mg/kg)

⁽¹⁾Values reported on a dry weight basis unless indicated.

⁽²⁾Lime treated sludges (10% or more lime by dry weight) should be analyzed for percent CaCO₃.

B. Additional parameters such as the organic chemicals listed in Table 12 may be required for screening purposes as well as aluminum (mg/kg), water soluble boron (mg/kg), calcium (mg/kg), chlorides (mg/l), manganese (mg/kg), sulfates (mg/kg), and those pollutants for which removal credits are granted.

C. Microbiological testing may be necessary to document the sludge treatment classification (Table 3). Microbiological standards shall be verified by the log mean of the analytical results from testing of nine or more samples of the sludge source. Sampling events shall be separated by an appropriate period of time so as to be representative of the random and cyclic variations in sewage characteristics.

TABLE 3
STANDARDS FOR DOCUMENTATION OF PATHOGEN CONTROL AND VECTOR ATTRACTION REDUCTION LEVELS FOR BIOSOLIDS

A. Pathogen control standards (dry weight of sludge solids basis):

1. Class I treatment for Class A pathogen control:

- a. ⁽¹⁾ ~~Composting or other acceptable time temperature treatment* shall result in a biosolids content equal to or less than either 1,000 fecal coliform per gram or three salmonella per four grams of total solids in treated sludge prior to removal for use or preparation for distribution.~~
- b. ~~Stabilization*⁽²⁾ Verify a biosolids content less than either 1,000 MPN fecal coliform per gram of total solids, or three salmonella, or one virus (PFU), or one helminth egg, per four grams of total sludge solids and provide that vector attraction reduction requirements will be met upon use.~~

2. Class II treatment for Class B pathogen control:

- a. ⁽¹⁾ ~~When the influent sludge stream to the stabilization unit operation contains more than 6 log₁₀ fecal coliform per gram of total solids, a reduction of 1.5 log₁₀ of fecal coliform or more may be required for stabilization.~~
- b. ~~Stabilization⁽²⁾. Verify biosolids content maximum of 6.3 log₁₀ of fecal coliform per gram of total solids in sludges subjected to adequate treatment and provide that vector attraction reduction requirements will be met upon use.~~

B. ~~Vector attraction reduction requirements (must satisfy one of the following for approval of land application of biosolids):~~

1. ~~Thirty eight percent volatile solids (VS) reduction by digestion processes, or:~~

- a. ~~Less than 38% reduction by anaerobic digestion if additional treatment (additional 40 days or more at 32°C or more) results in less than 17% additional VS reduction:~~

$$\text{Additional VS Reduction} = \frac{\text{VSD1} - \text{VSD2}}{\text{VSD1} - (\text{VSD1})(\text{VSD2})}$$

D1 = Initial conventional digestion period

D2 = Additional 40 day digestion period

- b. ~~Less than 38% reduction by aerobic digestion if the specific oxygen uptake rate (SOUR) of sludge is 1.5 or less milligrams of oxygen per hour per gram of total sludge solids (dry weight basis) at a temperature of 20°C.~~
- c. ~~Less than 38% reduction by aerobic digestion if additional treatment (additional 30 days or more at 20°C or more) results in less than 15% additional VS reduction.~~
- d. ~~Less than 38% reduction if treated in an adequately aerated unit operation for 14 days or more at a temperature exceeding 40°C and the average sludge temperature exceeds 45°C.~~

2. ~~Sludge pH is 12 or more (alkaline addition) for two consecutive hours and remains at 11.5 or higher for 22 additional hours (no further alkaline additions), or~~

3. ~~Seventy five percent or more total solids in treated sludge if no untreated primary sludge is included, or 90% total solids if unstabilized primary sludge is included, prior to any mixing with other materials, or~~

4. ~~Either incorporation of treated sludge into the soil within six hours of surface application, or direct injection below the surface of the land so that no evidence of any significant amounts of sludge is present on the land surface within one hour of injection.~~

5. ~~For land application of biosolids receiving Class I treatment:~~

- a. ~~For surface application: apply to land within eight hours of final treatment and incorporate below the surface within six hours of application, or achieve one of the appropriate vector attraction reduction requirements by treatment.~~
- b. ~~For subsurface application: inject within eight hours of final treatment or achieve one of the appropriate vector attraction reduction requirements by treatment.~~

C. ~~Documentation statement for submission of treatment, or quality, verification reports:~~

~~I have submitted the proper documentation to verify that the necessary levels of pathogen reduction and vector attraction reduction have been achieved for all sludge to be land applied in accordance with the permit requirements. These determinations have been made under my direction and supervision in accordance with approved procedures developed to ensure that qualified personnel obtain and evaluate the information necessary to ensure permit compliance. Also, the sludge quality characteristics are suitable for land application in accordance with permit requirements (if appropriate).~~

~~Signed by Responsible Person in Charge~~

~~(Title if appropriate) Date~~

⁽¹⁾Note: ~~Refers to an acceptable method of treatment with established operational controls capable of treating sludge to produce the required microbiological standards (see Article 3 (9VAC25-32-490 et seq.) of this part.~~

⁽²⁾Refers to testing standards.

*Specify the methods utilized to comply with treatment/application requirements on a separate attachment.

TABLE 5
RECOMMENDED SOIL TEST PARAMETERS FOR LAND APPLICATION SITES⁽⁴⁾

Parameter	BIOSOLIDS APPLICATION			STORAGE
	Infrequent ⁽²⁾	Frequent Below Agronomic Rates ⁽²⁾	Frequent at Agronomic ^{(2),(3)}	Supernatant ⁽⁴⁾
Soil organic matter (%)			*	*
Soil pH (Std. Units)	*	*	*	*
Cation exchange capacity (me/100g)			*	
Total nitrogen (ppm)			*	*
Organic nitrogen (ppm)			*	*
Ammonia nitrogen (ppm)			*	
Available phosphorus (ppm)	*	*	*	*
Exchangeable potassium (ppm)	*	*	*	
Exchangeable sodium (mg/100g)			*	*
Exchangeable calcium (mg/100g)			*	*
Exchangeable magnesium (mg/100g)	*		*	*
Copper (ppm)			*	*
Nickel (ppm)			*	*
Zinc (ppm)			*	*
Cadmium (ppm)			*	*
Lead (ppm)			*	*
Manganese (ppm)			*	
Molybdenum (ppm)			*	
Selenium (ppm)			*	
Particle size analysis or USDA Textural estimate (%)			*	*
Hydraulic conductivity (in/hr)				*

Regulations

⁽¹⁾Note: Unless otherwise stated, analyses shall be reported on a dry weight basis(*).

⁽²⁾See 9VAC25-32-560 B 3.

⁽³⁾Testing requirements to be adjusted in accordance with prior analytical test results. Heavy metal analyses are not required but once every three years before application.

⁽⁴⁾Liquid biosolids derived from biosolids use facilities.

TABLE 6
SUGGESTED GROUNDWATER
MONITORING PARAMETERS AND
MONITORING FREQUENCY

Annual Monitoring	Quarterly Monitoring
Total Kjeldahl Nitrogen	Nitrate Nitrogen
Ammonia Nitrogen	pH
Phosphorus	Conductivity
Sodium	Chlorides
Boron	Static Water Level
Copper	
Lead	
Nickel	
Cadmium	
Zinc	
Hardness	
Alkalinity	
COD (FOC)	
Pathogen Indicator Organism	

Article 3

Biosolids Use Standards and Practices

9VAC25-32-490. Compliance with biosolids use practices of this chapter.

Guidelines set forth in [~~9VAC25-32-500~~ 9VAC25-32-515] through [~~9VAC25-32-660~~ 9VAC25-32-580] of this regulation specify minimum standards for biosolids use for land application, marketing and distribution, including biosolids quality and site specific management practices. Compliance with this chapter will not be required for facilities not including land application, distribution, or marketing, which have received the approval of the

Commissioner of the State Department of Health and the State Water Control Board and for which operation has commenced as of January 1, 2008. Such operation of facilities is deemed to be commenced upon issuance of a certificate to operate in accordance with the Sewage Collection and Treatment Regulations (9VAC25-790). However, the board may impose standards and requirements that are more stringent than those contained in this regulation [~~when required to protect public health or prevent nuisance conditions from developing either within critical areas, or when special conditions develop prior to or during biosolids use operations according to the provisions of 9VAC25-32-100 E, 9VAC25-32-315, and 9VAC25-32-560 B 3~~]. Conformance to local land use zoning and planning should be resolved between the local government and the facility owner or permit holder. Applications submitted for facilities must demonstrate that the facility and biosolids use management practices will adequately safeguard public health and will comply with the certificate and permit requirements, as appropriate. Submissions that are in substantial compliance with this regulation and comply with any additional requirements as noted above will be approved. Justification for [~~biosolid~~ biosolids] use proposals may be required for those portions of the submitted proposal that differ from these criteria. The owner or owner's agent shall identify and justify noncompliance with specific standards or "shall" criteria that the department identifies, or the applicant, in his judgment, believes to be substantial in nature. The department may request changes in designs that are not in substantial compliance with this regulation and that are not adequately justified by the applicant. The fact that significant work was accomplished on a specific permit application prior to adoption of this regulation shall be a consideration when evaluating applications.

9VAC25-32-500. [~~Sludge~~ Biosolids management. (Repealed.)]

[~~A. Sludge~~ Biosolids management activities shall be described in a ~~sludge~~ biosolids operations management plan or a management practices plan submitted by the owner or the owner's agent to the department for review and approval in accordance with this section at the time of permit application. ~~Before sludge is utilized or disposed of, its potential effects on the land and state waters should be evaluated. Land application and facilities for biosolids use shall not result in flooding or pose a hazard to public health, wildlife, water quality, or other environmental resources as a result of biosolids transport due to flooding and subsequent runoff. Treatment works owners involved in biosolids use management practices may need to require pretreatment of~~

industrial waste for control of contaminants of concern in order to comply with this regulation.

~~B. The scope and purpose, requirements, and submission and approval of sludge management plans or management practices plans are described in this subsection.~~

~~1. The general purpose of these plans is to facilitate a determination by the board that the sludge management plan or management practices plan developed by the owner presents the necessary technical guidance and regulatory requirements to facilitate the proper management of sewage sludge including use of biosolids for both normal conditions and generally anticipated adverse conditions. The plan should be developed as a reference document, being as brief as possible while presenting the information in a clear, concise and readily accessible manner. The plan should be directed toward the management option(s) for biosolids use selected for the treatment works. The plan shall address methods of controlling and monitoring the quality of sludge by the owner and the means of use of biosolids developed from that sludge by the owner or his agent (9VAC25-32-670 and 9VAC25-32-680).~~

~~2. Complete sludge management plans or management practices plans shall be submitted for all biosolids use activities, by the owner, or owner's agent. The plan shall contain the elements required by applicable sections of this regulation (9VAC25-32-670 and 9VAC25-32-680).~~

~~3. Submission and approval of sludge management plans or management practices plans involving the land application of biosolids shall be at the time of permit application as follows:~~

~~a. Three copies of the final sludge management plan or management practices plan shall be submitted to the appropriate regional office. The technical evaluation of the plan will not commence until the applicant has submitted all necessary information.~~

~~b. Upon receipt of comments or no response by contacted agencies the department will complete the evaluation of the plan and the board will approve or disapprove the plan as technically adequate.~~

~~c. The board will approve the plan if it is determined that biosolids use will be in compliance with Article 2 (9VAC25-32-360 et seq.) of this part. If the board determines that substantial revision to the plan is required, the department shall send a letter to the owner and plan preparer, outlining the necessary revision and requesting submission of a revised plan within 60 days. A revised plan constitutes a resubmittal.~~

B. The biosolids operations management plan developed by the owner shall contain the necessary technical requirements to facilitate the proper management of sewage sludge and biosolids including use of biosolids for both normal conditions and generally anticipated adverse conditions. The plan shall be directed toward the management option or

options for biosolids use selected for the treatment works. The plan shall address methods of controlling and monitoring the quality of sludge by the owner and the means of use of biosolids developed from that sludge by the owner or his agent (9VAC25-32-60 F).

C. A complete biosolids operations management plan shall be submitted for all biosolids use activities, by the owner or owner's agent. The plan shall contain the elements required by applicable sections of this regulation (9VAC25-32-60 F and 9VAC25-32-410).]

9VAC25-32-510. General biosolids use standards. (Repealed.)

~~A. 9VAC25-32-510 and 9VAC25-32-550 provide minimum criteria that will be used for reviewing sludge management plans and management practices plans. Each plan shall address site specific management practices involving use of biosolids. Final disposition of sludge may involve use or disposal. For the purpose of 9VAC25-32-510 and 9VAC25-32-550, "use" shall include resource recovery, recycling or deriving beneficial use from the material. "Disposal" shall involve the final disposition of a waste material without resource recovery, recycling or deriving beneficial use from the material.~~

~~B. All practical use options should be evaluated before disposal options are evaluated or selected. Biosolids use practices include land application for agricultural, nonagricultural and silvicultural use and the distribution and marketing of exceptional quality biosolids. Sludge disposal methods include incineration, landfill codisposal, surface disposal, and other dedicated disposal practices, such as burial on dedicated disposal sites.~~

~~C. Water quality protection and monitoring provisions shall be included in all sludge management plans and management practices plans, except for those land application practices designed for limited loadings (amounts per area per time period) within defined field areas in agricultural use. Groundwater monitoring requirements shall be evaluated by the board for annual application of biosolids to specific sites, reclamation of disturbed and marginal lands and application to forest land (silviculture). Submittal of site specific (soils and other) information for each identified separate field area shall be required for issuance of permits. For information regarding handling and disposal of septage, refer to the Sewage Handling and Disposal Regulations, 12VAC5-610. Septage treated and managed in accordance with standards contained in this regulation is defined as either sewage sludge or as biosolids as appropriate.~~

~~D. Conformance of biosolids use to local land use zoning and planning should be resolved between the local government and the permit applicant. The permit applicant shall attempt to notify land owners of property within 200 feet and 1,000 feet of the boundaries of sites proposed for frequent use and dedicated sites, respectively, and furnish the department and the chief executive officer or designee for the~~

Regulations

local government where the site is located with acceptable documentation of such notifications (i.e., intent to land apply biosolids on the proposed locations). Relevant concerns of adjacent landowners will be considered in the evaluation of site suitability.

E. The requirements for processing approvals of sludge management plans and management practices plans are included in 9VAC25-32-500 B as well as (i) requirements for notification of applications, hearings and meetings, and (ii) minimum information required for completion of a sludge management plan for land application (9VAC25-32-670 and 9VAC 25-32-680).

F. At least 100 days prior to commencing land application of biosolids at a permitted site, the permit holder shall deliver or cause to be delivered written notification that is substantially in compliance with this section to the chief executive officer or designee for the local government where the site is located. This requirement may be satisfied by providing a list of available permitted sites in the locality at least 100 days prior to commencing the application at any site on the list. If the site is located in more than one county, the information shall be provided to all jurisdictions where the site is located. Sufficiency of such notices shall be determined by the department.

G. The notification required by this section shall include the following:

1. The name, address and telephone number of the permit holder, including the name of a representative knowledgeable of the permit;
2. Identification by tax map number and farm service agency (FSA) farm tract number of parcels on which land application is to take place;
3. A map indicating haul routes to each site where land application is to take place;
4. The name or title, and telephone number of at least one individual designated by the permit holder to respond to questions and complaints related to the land application project;
5. The approximate dates on which land application is to begin and end at the site;
6. The name and telephone number of the person or persons at the Virginia Department of Health to be contacted in connection with the permit; and
7. The name, address, and telephone number of the wastewater treatment facility, or facilities, from which the biosolids will originate, including the name or title of a representative of the treatment facility that is knowledgeable about the land application operation.

H. The permit holder shall deliver or cause to be delivered written notification to the department as least 14 days prior to commencing land application of sewage sludge at a permitted site. The notice shall identify the location of the permitted site

and the expected sources of the sewage sludge to be applied to the site.

I. Within 24 hours of receiving notification of a complaint, the permit holder shall commence investigation of said complaint. The permit holder shall confirm receipt of a complaint by phone, email or facsimile to the department, the chief executive officer or designee for the local government of the jurisdiction in which the complaint originates, and the owner of the treatment facility from which the biosolids originated within 24 hours after receiving the complaint. Complaints and responses thereto shall be documented by the permit holder and submitted with monthly land application reports to department and copied to the chief executive officer or designee for the local government and the owner of the treatment facility from which the biosolids originated.

Localities receiving complaints concerning land application of sewage sludge shall notify the department and the permit holder.

9VAC25-32-515. Notification of land application activity.

A. Written notification.

1. At least 100 days prior to commencing [the first] land application of biosolids at a permitted site, the permit holder shall deliver or cause to be delivered written notification to the chief executive officer or designee for the local government where the site is located. This requirement may be satisfied by [the department's notice to the local government at the time of receiving the permit application if all necessary information is included in the notice or by] providing a list of available permitted sites in the locality at least 100 days prior to commencing the application at any site on the list. If the site is located in more than one county, the information shall be provided to all jurisdictions where the site is located.

2. At least 14 days prior to commencing land application of biosolids at a permitted site, the permit holder shall deliver or cause to be delivered written notification to the department and the chief executive officer or designee for the local government where the site is located [unless they request in writing not to receive the notice. The notice shall identify the location of the permitted site and the expected sources of the biosolids to be applied to the site]. [The notice shall include the following:

a. The name, address, and telephone number of the permit holder, including the name of a representative knowledgeable of the permit;

b. Identification by tax map number and the DEQ control number for sites on which land application is to take place;

c. A map indicating haul routes to each site where land application is to take place;

d. The name or title and telephone number of at least one individual designated by the permit holder to respond to

~~questions and complaints related to the land application project;~~

~~e. The approximate dates on which land application is to begin and end at the site;~~

~~f. The name and telephone number of the person or persons at the department to be contacted in connection with the permit; and~~

~~g. The name, address, and telephone number of the wastewater treatment facility, or facilities, from which the biosolids will originate, including the name or title of a representative of the treatment facility that is knowledgeable about the land application operation.~~

~~If multiple sites are included in the notification, the permit holder shall make a good faith effort to identify the most probable order that land application will commence.]~~

~~3. [The Not more than 24 hours prior to commencing land application activities, including delivery of biosolids at a permitted site, the] permittee shall [deliver or cause to be delivered daily notification to notify in writing] the department and the chief executive officer or designee for the local government where the site is located [prior to commencing planned land application activities. unless they request in writing not to receive the notice. This notification shall include identification of the biosolids source and shall include only sites where land application activities will commence within 24 hours or where biosolids will be staged within 24 hours.]~~

B. Posting signs.

1. At least five business days prior to delivery of biosolids for land application on any site permitted under this regulation, the permit holder shall post signs at the site that comply with this section, are visible and legible from the public right-of-way in both directions of travel, and conform to the specifications herein. The sign shall remain in place for at least five business days after land application has been completed at the site. [The permit holder shall not remove the signs until at least 30 days after land application has been completed at the site.]

a. [A sign shall be posted at or near the intersection of the public right-of-way and the main site access road or driveway to the site used by the biosolids transport vehicles.

b.] If the [site field] is located adjacent to a public right-of-way, [signs at least one sign] shall be posted along each [public] road frontage beside the field to be land applied.

[b. If the site is not located adjacent to a public right of way, the sign shall be posted at or near the intersection of the public right of way and the main site access road or driveway to the site.]

c. The department may grant a waiver to the requirements in this section, or require alternative posting options due to extenuating circumstances or [to be

consistent where requirements conflict] with local government ordinances and other requirements regulating the use of signs.

[2. Upon the posting of signs at a land application site prior to commencing land application, the permittee shall deliver or cause to be delivered written notification to the department and the chief executive officer or designee for the local government where the site is located unless they request in writing not to receive the notice. Notification shall be delivered to the department within 24 hours of the posting of signs. The notice shall include the following:

a. The name and telephone number of the permit holder, including the name of a representative knowledgeable of the permit;

b. Identification by tax map number and the DEQ control number for sites on which land application is to take place;

c. The name or title and telephone number of at least one individual designated by the permit holder to respond to questions and complaints related to the land application project if not the permit holder identified in 9VAC25-32-515 B 2 a;

d. The approximate dates on which land application is to begin and end at the site; and

e. The name, address, and telephone number of the wastewater treatment facility or facilities from which the biosolids will originate, including the name or title of a representative of the treatment facility who is knowledgeable about the land application operation.

~~2.~~ 3.] The sign shall be made of weather-resistant materials and shall be sturdily mounted so as to be capable of remaining in place and legible throughout the period that the sign is required at the site. Signs required by this section shall be temporary, nonilluminated, and four square feet or more in area, and only contain the following information:

a. A statement that biosolids are being land-applied at the site;

b. The name [~~and telephone number~~] of the permit holder [~~and the name or title and;~~

c. The] telephone number of an individual designated by the permit holder to respond to complaints and inquiries; and

[~~e. d.] Contact information for the department, including a telephone number for complaints and inquiries.~~

[~~3.~~ 4.] The permit holder shall make a good faith effort to replace or repair any sign that has been removed from a land application site or that has been damaged so as to render any of its required information illegible prior to five business days after completion of land application.

C. Handling of complaints.

Regulations

1. Within 24 hours of receiving notification of a complaint, the permit holder shall commence investigation of said complaint and shall determine whether the complaint is substantive. The permit holder shall confirm receipt of all substantive complaints by phone, email, or facsimile to the department, the chief executive officer or his designee for the local government of the jurisdiction in which the complaint originates, and the owner of the treatment facility from which the biosolids originated within 24 hours after receiving the complaint.

2. For the purposes of this section, a substantive complaint shall be deemed to be any complaint alleging a violation of these regulations, state law, or local ordinance; a release of biosolids to state waters or to a public right-of-way or to any location not authorized in the permit; or failure to comply with the nutrient management plan for the land application site.

3. Localities receiving complaints concerning land application of biosolids shall notify the department and the permit holder within 24 hours of receiving the complaint.

9VAC25-32-520. Sludge quality and composition. (Repealed.)

~~A. Sampling and testing sludge. Samples shall be collected so as to provide a representative composition of the sludge. Analytical testing shall be performed by a laboratory capable of testing in accordance with current EPA approved methods or other accepted methods. The operational section of this regulation establishes the minimum constituents that shall be analyzed and the sampling and preservation procedures that should be utilized. The sludge management plan or management practices plan shall detail both the sampling and testing methods used to characterize the sludge.~~

~~B. Nonhazardous declaration. Regulations under the Resource Conservation and Recovery Act (RCRA) and the Virginia Hazardous Waste Management Regulations (9VAC20-60) identify listed hazardous wastes and hazardous waste characteristics. Municipal wastewater or sewage sludge is neither excluded nor specifically listed as hazardous waste. Hazardous wastes as established through RCRA and appropriate state regulations are not managed under this regulation. The owner shall monitor sludge characteristics as required to determine if it is hazardous or nonhazardous and declare to the department that the sludge generated at his facility is nonhazardous.~~

~~C. Sludge treatment. Sludges shall be subjected to a treatment process sequence designed to reduce both the pathogen content and the solids content to the appropriate level for the selected method of management, such as land application. For such use options, the sludge treatment provided shall minimize the potential for vector attraction and prevent objectionable odor problems from developing during management. Acceptable levels of pathogen reduction may be achieved by various established conventional treatment methods including Class I treatment to accomplish Class A~~

~~pathogen control and Class II treatment to accomplish Class B pathogen control 9VAC25-32-610. The level of pathogen control achieved by nonconventional treatment must be verified by microbiological monitoring (Table 3).~~

~~For land application, Class B pathogen, or better, shall be achieved. Such Class I or II treatment may involve either: anaerobic or aerobic digestion, high or low temperature composting, heat treatment, air drying, or chemical treatment processes utilizing alkaline additives or chlorine. For use of treated sludge or sludge products involving a high potential for public contact, it may be necessary to achieve further pathogen reduction (Class A) beyond that attained by the above processes. Such Class I treatment may be accomplished by (i) heat treatment and drying, (ii) thermophilic composting, (iii) alkaline treatment. A three log reduction or more (a thousand fold reduction) in pathogenic bacteria and viral microorganisms to meet conventional treatment standards. Raw sludge levels of pathogenic bacteria and viral microorganisms can be effectively reduced to safe levels by conventional Class I treatment methods.~~

~~Properly treated sludges can be safely utilized and should not create any nuisance problems when managed in accordance with approved sludge management or management practices plans. A sludge that receives Class I or II treatment for adequate pathogen control and is treated or managed to properly reduce vector attraction and pollutants within acceptable levels (Table 7 A) is referred to as "biosolids." A Class I treated sludge with approved control of vector attraction and acceptable levels of pollutants (Table 7 A) is referred to as "exceptional quality biosolids."~~

~~D. Sludge composition. The characterization of sludge properties is a necessary first step in the design of a use/disposal system. Monitoring and testing for certain pollutants shall be achieved prior to specific use or disposal practices. For the purposes of this regulation, sludge management and testing methods shall account for moisture content including (i) liquid sludge defined as sludges with less than 15% total solids, (ii) dewatered sludge normally defined as sludges with 15% to 30% total solids; or (iii) dried sludge normally defined as sludges with more than 30% total solids.~~

9VAC25-32-530. Land acquisition and management control.

~~A. When an application to permit land application of sludge biosolids is proposed, submitted to the department, the permit applicant shall ensure the continued availability of the land and protection from improper concurrent use during the utilization period shall be assured. A written agreement shall be established between the landowner and owner to be submitted with the permit application, whereby the landowner, among other things, shall consent to apply sewage sludge on his property. The responsibility for obtaining and maintaining the agreements lies with the party who is the holder of the permit. Site management controls shall include~~

access limitations relative to the level of pathogen control achieved during treatment. In addition, agricultural use of sludge in accordance with this regulation is not to result in harm to threatened or endangered species of plant, fish, or wildlife, nor result in the destruction or adverse modification of the critical habitat of a threatened or endangered species. Site specific information shall be provided as part of the sludge management or management practices plan.

B. Land acquisition requirements.

1. Permit holders shall use a unique control number assigned by the department as an identifier for fields permitted for land application.

2. A written agreement shall be established between the landowner and permit applicant or permit holder [to be submitted with the permit application], whereby the landowner shall consent to apply biosolids on his property [and certify that no concurrent agreements exist for the fields to be permitted]. The landowner agreement shall include [an acknowledgment by the landowner of any site restrictions identified in the permit. The responsibility for obtaining and maintaining the agreements lies with the permit holder. The written agreement shall be submitted to the department with the permit application.]

(a) A statement certifying that the landowner is the sole owner or one of multiple owners of the property or properties identified on the landowner agreement;

(b) A statement certifying that no concurrent agreements are in effect for the fields to be permitted for biosolids application;

(c) An acknowledgement that the landowner shall notify the permittee when land is sold or ownership transferred;

(d) An acknowledgement that the landowner shall notify the permittee if any conditions change such that any component of the landowner agreement becomes invalid;

(e) Permission to allow department staff on the landowner's property to conduct inspections;

(f) An acknowledgement by the landowner of any site restrictions identified in the regulation;

(g) An acknowledgement that the landowner has received a biosolids fact sheet approved by the department; and

(h) An acknowledgement that the landowner shall not remove notification signs placed by the permit holder.]

3. New landowner agreements [using the most current form provided by the board] shall be submitted to the department [with for proposed land application sites identified in] each application for issuance or reissuance of a permit or the modification to add land to an existing permit that authorizes the land application of biosolids.

[4. For permits modified in order to incorporate changes to this regulation, the permit holder shall, within 60 days of the effective date of the permit modification, advise the landowner by certified letter of the requirement to provide

a new landowner agreement. The letter shall include instructions to the landowner for signing and returning the new landowner agreement, and shall advise the landowner that the permit holder's receipt of such new landowner agreement is required prior to application of biosolids to the landowner's property.

5. The responsibility for obtaining and maintaining the agreements lies with the permit holder. The written agreement shall be submitted to the department with the permit application.]

B. At least 48 hours prior to delivery of biosolids for land application on any site permitted under this regulation, the permit holder shall post a sign at the site that substantially complies with this section, is visible and legible from the public right of way, and conforms to the specifications herein. If the site is not located adjacent to a public right of way, the sign shall be posted at or near the intersection of the public right of way and the main site access road or driveway to the site. The department may grant a waiver to this or any other requirement, or require alternative posting options due to extenuating circumstances. The sign shall remain in place for at least 48 hours after land application has been completed at the site.

C. The sign shall be made of weather resistant materials and shall be sturdily mounted so as to be capable of remaining in place and legible throughout the period that the sign is required at the site. Signs required by this section shall be temporary, nonilluminated, four square feet or more in area and shall only contain the following information:

1. A statement that biosolids are being land-applied at the site;

2. The name and telephone number of the permit holder as well as the name or title, and telephone number of an individual designated by the permit holder to respond to complaints and inquiries; and

3. Contact information for the Virginia Department of Health, including a telephone number for complaints and inquiries.

D. The permit holder shall promptly replace or repair any sign that has been removed from a land application site prior to 48 hours after completion of land application or that has been damaged so as to render any of its required information illegible.

9VAC25-32-540. Transport.

A. Transport routes should follow primary highways, should avoid residential areas when possible, and should shall comply with all Virginia Department of Transportation requirements and standards. Transport vehicles shall be sufficiently sealed to prevent leakage and spillage of sludge biosolids. For sludges biosolids with a solids content of less than 15%, totally closed watertight transport vehicles with rigid tops shall be provided to prevent spillage unless adequate justification is provided to demonstrate that such

Regulations

controls are unnecessary. The board may also require certain dewatered ~~sludges~~ biosolids exceeding 15% solids content to be handled as liquid ~~sludges~~ biosolids. The minimum information for ~~sludge~~ biosolids transport that shall be supplied in the ~~sludge~~ biosolids [~~operations~~] management plan is listed in ~~9VAC25-32-670 and 9VAC25-32-680~~ 9VAC25-32-60 F.

B. The permit holder shall be responsible for the prompt cleanup and removal of biosolids spilled during transport ~~to the land application site or to or from a storage facility~~. The operations manual shall include a plan for the prevention of spills during transport and for the cleanup and removal of spills. The permit holder shall ensure that its personnel, subcontractors or the drivers of vehicles transporting biosolids for land application shall be properly trained in procedures for spill removal and cleanup.

C. The permit holder shall take appropriate steps to prevent drag-out and track-out of dirt and debris or biosolids from land application sites onto public roads. Where material is transported onto a paved or public road surface, the road surface shall be cleaned thoroughly as soon as practicable, but no later than the end of each day.

D. The permit holder shall promptly report offsite spills to the [~~Virginia Department of Health~~ Environmental Quality department], the chief executive officer or designee for the local government and the owner of the facility generating the biosolids. The report shall be made verbally as soon as possible, but no later than 24 hours after the discovery of the spill. After business hours notification may be provided by voicemail, facsimile or email.

E. A written report, which shall include a description of measures taken in response to the spill, shall be submitted by the permit holder to the ~~Virginia Department of Health~~ department, the chief executive officer or designee for the local government, and the owner of the facility generating the biosolids within five working days of the spill. The report may be sent by first class mail, facsimile or email, or it may be hand delivered.

9VAC25-32-545. Staging of biosolids for land application.

A. ~~Staging [of biosolids shall not commence unless the field meets the requirements for land application] is the placement of biosolids on a permitted land application field, within the land application area, in preparation for commencing land application or during an ongoing application, at the field or an adjacent permitted field. Staging is not considered storage and shall not take the place of storage [.~~

B. Staging requirements.

1. [~~Biosolids that have been staged for greater than seven days shall be spread as soon as field conditions become favorable for land application or removed from the field; Staging of biosolids shall not commence unless the field meets the requirements for land application in accordance~~

~~with Part IX (9VAC25-32-303 et seq.) of this regulation and field conditions are favorable for land application;]~~

2. [~~No liner or cover is required under or over staged biosolids if spread within 14 days; Biosolids may be staged for up to seven days from the first day biosolids are offloaded onto the staging area, with the following exceptions:~~

~~a. In areas of Karst topography, biosolids offloaded at a permitted land application field shall be land applied by the end of the business day;~~

~~b. In areas identified in the USDA soil survey as frequently flooded, biosolids offloaded at a permitted land application field shall be land applied by the end of the business day; or~~

~~c. Biosolids shall not be staged overnight on sites that have on-site storage;]~~

3. [~~Staged~~ If staged] biosolids [~~that~~] cannot be spread [~~within 14 days shall be covered to prevent contact with precipitation;~~ by the end of the seventh day of staging, the permittee shall take the following actions:

~~a. Biosolids shall be covered to prevent contact with precipitation;~~

~~b. The permittee shall notify the department in writing within 24 hours. Notification shall include the biosolids source or sources and amounts, location of the site, and reason for staging biosolids longer than seven days; and~~

~~c. Biosolids that have been staged for greater than seven days shall be spread or removed from the field as soon as field conditions become favorable for land application;]~~

[~~4. The certified land applier shall notify the department within 24 hours when it is necessary to stage biosolids for land application. Notification shall include source or sources, location, amounts, and reason for staging;~~

~~5- 4.] Staging shall be limited to the amount of biosolids specified in the nutrient management plan to be applied at the intended field;~~

[~~6- 5.] Biosolids will be staged within the land application area of the field in which the biosolids will be applied or in a permitted field adjacent to the subject field, in a location selected to prevent runoff to waterways and drainage ditches;~~

[~~7- 6.] Biosolids shall not be staged in the [~~buffer zones~~ setback areas];~~

[~~7. Biosolids shall not be staged overnight within 400 feet of an occupied dwelling unless reduced or waived through written consent of the occupant and landowner;~~

~~8. Biosolids shall not be staged overnight within 200 feet of a property line unless reduced or waived through written consent of the landowner;~~

~~8- 9.] Management practices, as described in the [~~operations manual~~ biosolids management plan], shall be~~

utilized as appropriate to prevent pollution of state waters by staged biosolids;

~~[9. 10.] Staged biosolids are to be inspected by the certified land applier [at least every seven days and after daily. After] precipitation events of 0.1 inches or greater [to inspections shall] ensure that runoff controls are in good working order. Observed excessive slumping, erosion, or movement of biosolids is to be corrected within 24 hours. Any ponding [or malodor] at the site is to be corrected [and any malodor shall be addressed in accordance with the odor control plan]. The certified land applier shall maintain documentation of the inspections of staged biosolids; [and]~~

~~[10. Staging shall be prohibited in areas identified in the USDA soil survey as frequently flooded;~~

~~11. No staging shall take place in areas of karst topography;~~

~~12. 11.] Staged biosolids shall be managed so as to prevent adverse impacts to water quality or public health [; and~~

~~13. Biosolids shall not be staged on sites that have on-site storage].~~

9VAC25-32-550. Storage facilities.

A. No person shall apply to the ~~Department of Environmental Quality~~ department for a permit, a variance, or a permit modification authorizing storage of ~~sewage sludge biosolids~~ without first complying with all requirements adopted pursuant to § 62.1-44.19:3 R of the Code of Virginia.

B. ~~Three Two~~ types of storage may be integrated into a complete ~~sludge biosolids [operations]~~ management plan including (i) "emergency storage" involving immediate implementation of storage for any sludge that becomes necessary due to unforeseen circumstances, (ii) "temporary storage" involving the provision of storage of stabilized sludges at the land application site that becomes necessary due to unforeseen climatic events that preclude land application of biosolids in the day that it is transported from the generator, or (iii) "routine storage" involving the storage of biosolids as necessary for all nonapplication periods of the year. Only routine storage facilities shall be considered a facility under this regulation.:

1. On-site storage, or

2. Routine storage. Only routine storage facilities shall be considered a facility under this regulation.

C. Emergency storage. The owner shall notify the department upon implementation of any emergency storage. Approval of such storage and subsequent processing of the sludge and supernatant will be considered as a contingency plan integrated into the sludge management plan. Only emergency storage shall be used for storage of unstabilized sludges. Further processing utilization and disposal shall be conducted in accordance with the approved sludge management plan. Design and implementation of facilities

used for emergency storage shall not result in water quality, public health or nuisance problems.

~~D. Temporary storage. The owner shall notify the department whenever it is necessary to implement temporary storage. Temporary storage may be utilized at the land application site due to unforeseen climatic factors that preclude application of sludge (either offloaded at the site or in transport to the site) to permitted sites within the same working day. Temporary storage is not to be used as a substitute for routine storage and is restricted as follows:~~

1. Sludge stored at the site shall be land applied prior to additional offloading of sludge at the same site;

2. The owner shall be restricted to storing a daily maximum amount of 100 wet tons per operational site;

3. The stored sludge shall be land applied within 30 days from the initiation of storage or moved to a routine sludge facility;

4. Approval of plans for temporary storage will be considered as part of the overall sludge management plan;

5. Temporary storage shall not occur in areas prone to flooding at a 25 year or less frequency interval;

6. A synthetic liner shall be required for placement under and over sludge stored in this manner with one exception: where sludge is stockpiled for less than seven days, a liner placed under the stored sludge is not required. Surface water diversions and other best management provisions (BMP) should be utilized as appropriate; and

7. Temporary storage shall not result in water quality, public health or nuisance problems.

C. [All on-site storage and routine storage facilities shall comply with the requirements of this section by [12 months from the effective date of this regulation].

D.] On-site storage. On-site storage is the short-term storage of biosolids [on a constructed surface] within a site approved for land application [on a constructed surface] at a location preapproved by the department. These stored biosolids shall be applied only to sites under the operational control of the same owner or operator of the site where the on-site storage is located. Requirements for on-site storage include the following:

1. The certified land applier shall notify the department within the same working day whenever it is necessary to implement on-site storage. Notification shall include the source or sources, location, and amounts;

2. A surface shall be constructed with sufficient strength to support operational equipment and with a maximum permeability of 10⁻⁷ cm/sec;

3. Storage shall be limited to the amount of biosolids specified in the nutrient management plan to be applied at sites under the operational control of the same owner or operator of the site where the on-site storage is located;

Regulations

4. If malodors related to the stored biosolids are verified by the department at any occupied dwelling on surrounding property, the problem must be corrected within 48 hours. If the problem is not corrected within 48 hours, the biosolids must be removed from the storage site;

5. All biosolids stored on the on-site storage pad shall be land applied by the 45th day from the first day of on-site storage;

6. Biosolids storage shall be located to provide minimum visibility [from adjacent properties];

7. Best management practices shall be utilized as appropriate to prevent contact with storm water run on or runoff;

8. Stored biosolids are to be inspected by the certified land applier at least every seven days and after precipitation events of 0.1 inches or greater to ensure that runoff controls are in good working order. Observed excessive slumping, erosion, or movement of biosolids is to be corrected within 24 hours. Any ponding or malodor at the [storage] site is to be corrected. The certified land applier shall maintain documentation of inspections of stored biosolids;

9. The department may prohibit or require additional restrictions for on-site storage in areas of [karst Karst] topography and environmentally sensitive sites; [and]

10. [Biosolids shall not be stockpiled on sites that have on-site storage; and

11. Biosolids shall not result in Storage of biosolids shall be managed so as to prevent adverse impacts to] water quality [or] public health [, or nuisance problems].

[E. ~~D.~~] Routine storage. Routine storage is the long-term storage of biosolids at a facility [not located at the site of the wastewater treatment plant,] preapproved by the department and constructed specifically for the storage of biosolids to be applied at any [permitted] site [included in permits held by the permit holder of the storage facility]. Routine storage facilities shall be provided for all land application projects if no alternative means of management is available during nonapplication periods. No person shall apply to the department for a permit, a variance, or a permit modification authorizing storage of biosolids without first complying with all requirements adopted pursuant to § 62.1-44.19:3 A 5 of the Code of Virginia. Plans and specifications for any surface storage facilities (pits, ponds, lagoons) or aboveground facilities (tanks, pads) shall be submitted as part of the minimum information requirements. The minimum information requirements include:

1. Location.

a. The facility shall be located at an elevation that is not subject to, or is otherwise protected against, inundation produced by the 100-year flood/wave action as defined by U.S. Geological Survey or equivalent information.

b. Storage facilities should be located to provide minimum visibility.

c. ~~All storage facilities with a capacity in excess of 100 wet tons and~~ located offsite of property owned by the generator shall be provided with a minimum 750-foot [~~buffer zone setback area~~]. The length of the [~~buffer zone setback area~~] considered will be the distance measured from the perimeter of the storage facility. Residential uses, high-density human activities and activities involving food preparation are prohibited within the [~~buffer zone setback area~~]. The board may [~~consider a reduction of up to half of the above buffer~~ reduce the setback] requirements based on [site-specific factors,] such [~~facts~~] as [~~lagoon area facility size~~], topography, prevailing wind direction, and the inclusion of an effective windbreak in the overall design.

2. Design capacity.

a. The design capacity for storage of liquid biosolids shall be sufficient to store a minimum volume equivalent to 60 days or more average production of biosolids and the incidental wastewater generated by operation of the treatment works plus sufficient capacity necessary for: (i) the 25 year-24 hour design storm (incident rainfall and any runoff as may be present); (ii) net precipitation excess during the storage period; and (iii) an additional one foot freeboard from the maximum water level (attributed to the sum of the above factors) to the top berm elevation. Storage capacity of less than that specified above will be considered on a case-by-case basis only if sufficient justification warrants such a reduction.

b. If alternative methods of management cannot be adequately verified, contractors [~~should~~ shall] provide for a minimum of 30 days of in-state routine storage capacity for the average quantity of ~~sludge~~ biosolids transported into Virginia from out-of-state treatment works generating at least a Class [~~H-level treated B~~] sludge biosolids.

3. [Construction Facility design].

[a. All drawings and specifications shall be submitted in accordance with 9VAC25-790-160.

b.] The biosolids shall be stored on an engineered surface with a maximum permeability of 10⁻⁷ cm/sec and of sufficient strength to support operational equipment.

[~~b. c.~~] Storage facilities designed to hold dewatered biosolids shall be constructed with a cover to prevent contact with precipitation.

[~~e. d.~~ Existing facilities permitted as routine storage facilities and designed to contain liquid biosolids may be used to store dewatered biosolids. The supernatant shall be managed as liquid biosolids in accordance with 9VAC25-32-550 E 5 d. Freeboard shall be maintained in accordance with 9VAC25-32-550 E 5 c. The department

may require additional monitoring prior to land application.

~~e.~~ Storage facilities shall be of uniform shape (round, square, rectangular) with no narrow or elongated portions. ~~The facilities shall be lined in accordance with the requirements contained in sewerage regulations or certificate.~~

~~d. f.~~ The facilities shall also be designed to permit access of equipment necessary for loading and unloading biosolids, and ~~should~~ shall be designed with receiving facilities to allow for even distribution of ~~sludge biosolids~~ into the facility.

~~e. g.~~ ~~Design should~~ The design shall also provide for truck cleaning facilities ~~as may be necessary~~. ~~Storage facilities with a capacity of 100 wet tons or less shall comply with the provision for temporary storage as a minimum.~~

4. Monitoring. All ~~sludge biosolids~~ storage facilities [~~in excess of 100 wet ton capacity~~] shall be monitored in accordance with the requirements of this regulation. Plans and specifications shall be provided for such a monitoring program in accordance with the minimum information specified in ~~Article 4 (9VAC25-32-670 et seq.) of this part 9VAC25-32-60 F and 9VAC25-32-410.~~

5. Operation.

a. Only biosolids suitable for land application (Class A or B biosolids) shall be placed into permitted routine storage facilities.

b. Storage of biosolids located offsite or remote from the wastewater treatment works during the summer months shall be avoided whenever possible so that the routine storage facility remains as empty as possible during the summer months.

c. Storage facilities ~~should~~ shall be operated in a manner such that sufficient freeboard is provided to ensure that the maximum anticipated high water elevation due to any and all design storm inputs is not less than one foot below the top berm elevation.

d. Complete plans for supernatant disposal shall be provided in accordance with ~~Article 4 (9VAC25-32-670 et seq.) of this part 9VAC25-32-60 F.~~ Plans for supernatant disposal may include transport to the sewage treatment works, mixing with the biosolids for land application or land application separately. However, separate land application of supernatant will be regulated as liquid ~~sludge biosolids~~; additional testing, monitoring and treatment (disinfection) may be required.

e. The facility site shall be fenced to a minimum height of five feet; gates and locks shall be provided to control access. The fence ~~should~~ shall be posted with signs identifying the facility. The fence ~~should~~ shall not be constructed closer than 10 feet to the outside edge of the facility or appurtenances, to allow adequate accessibility.

f. If malodors related to the stored biosolids are verified by [~~DEQ the department~~] at any occupied dwelling on surrounding property, the malodor must be corrected within 48 hours.

6. Closure. An appropriate plan of closure or abandonment shall be developed by the permittee when the facility ceases to be utilized and approved by the board. Such plans may also be reviewed by the Department of Health.

7. Recordkeeping. A manifest system shall be developed, implemented and maintained and be available for inspection during operations as part of the overall daily recordkeeping for the project ~~Article 4 (9VAC25-32-670 et seq.) of this part (9VAC25-32-60 F).~~

9VAC25-32-560. Biosolids utilization methods.

A. Requirements applicable to land application of biosolids.

1. All biosolids application rates, application times and other site management operations shall be restricted as specified in the [~~approved operations biosolids~~] management ~~practices~~ plan. The [~~operations biosolids~~] management ~~practices~~ plan shall include a nutrient management plan as required by ~~9VAC25-32-680 9VAC25-32-410~~ and prepared by a certified nutrient management planner as stipulated in regulations promulgated pursuant to § 10.1-104.2 of the Code of Virginia.

~~a. A nutrient management plan shall be developed for all application sites prior to biosolids application.~~

~~b. All nutrient management plans shall account for all sources of nutrients to be applied to the site and include at a minimum the following information:~~

~~(1) A site map indicating the location of any waste storage facilities and the fields where biosolids or animal waste will be applied;~~

~~(2) Site evaluation and assessment of soil types and potential productivities;~~

~~(3) Nutrient management sampling including soil monitoring;~~

~~(4) Biosolids or animal waste application rates based on the overall nutrient requirements of the proposed crop and soil monitoring results; and~~

~~(5) Biosolids and other nutrient source application schedules and land area requirements.~~

~~e. The nutrient management plan shall be available for review by the department at the land application site during biosolids land application.~~

~~d. Within 30 days after land application at the site has commenced, the permit holder shall provide a copy of the nutrient management plan to the department, the farm operator of the site, the Department of Conservation and Recreation regional office, and the chief executive officer or designee for the local government, unless they request in writing not to receive the nutrient management plan.~~

Regulations

~~e. The nutrient management plan must be approved by the Department of Conservation and Recreation prior to land application for application sites where the soil test phosphorus levels exceed the values in Table 1 of this section. For purposes of approval, permittees should submit the nutrient management plan to the Department of Conservation and Recreation at least 30 days prior to the anticipated date of land application to ensure adequate time for the approval process.~~

<u>TABLE 1</u> <u>SOIL PHOSPHORUS LEVELS REQUIRING</u> <u>NMP APPROVAL</u>	
<u>Region</u>	<u>Soil Test P (ppm)</u> <u>VPI & SU Test</u> <u>(Mehlich D)*</u>
<u>Eastern Shore and Lower Coastal Plain</u>	<u>135</u>
<u>Middle and Upper Coastal Plain and Piedmont</u>	<u>136</u>
<u>Ridge and Valley</u>	<u>162</u>
<u>*If results are from another laboratory, the Department of Conservation and Recreation approved conversion factors must be used.]</u>	

2. Biosolids shall be treated to meet standards for land application as required by Part IX (9VAC25-32-310 et seq.) (9VAC25-32-303 et seq.) of this chapter prior to delivery at the land application site. No person shall alter the composition of biosolids at a site approved for land application of biosolids under a Virginia Pollution Abatement Permit. Any person who engages in the alteration of such biosolids shall be subject to the penalties provided in Article 6 (§ 62.1-44.31 et seq.) of Chapter 3.1 of Title 62.1 of the Code of Virginia. The addition of lime or deodorants to biosolids that have been treated to meet standards for land application as required by Part IX (9VAC25-32-310 et seq.) (9VAC25-32-303 et seq.) of this chapter shall not constitute alteration of the composition of biosolids. The board may authorize public institutions of higher education to conduct scientific research on the composition of biosolids that may be applied to land.

B. Agricultural use. Agricultural use of ~~sewage sludge biosolids~~ is the land application of biosolids (Table 7) to cropland or pasture land to obtain agronomic benefits as a plant nutrient source and soil conditioner. ~~This use shall require a system design that ensures that the land application procedures are performed in accordance with sound agronomic principles.~~

1. Sludge Biosolids treatment. As a minimum, biosolids that are applied to the land or incorporated into the soil shall be treated by a Class II pathogen treatment process

and shall be treated or managed to provide an acceptable level of vector attraction reduction.

2. Site soils. ~~Soils best suited for agricultural use should possess good tilth and drainage capabilities, have moderate to high surface infiltration rates and moderate to slow subsoil permeability. Depth to bedrock or restrictive layers should be a minimum of 18 inches. Depth to the seasonal water table should exceed 18 inches as defined by the Soil Conservation Service soil survey. If such information is not available the water table depth may be determined by soil characteristics or water table observations. If the soil survey or such evidence indicates that the seasonal water table can be less than 18 inches below the average ground surface, soil borings shall be utilized within seven days prior to land application operations during periods of high water table for the soil series present, to verify that the 18-inch depth restriction is complied with during field operations. The use of soil borings and water table depth verification may be required for such sites from November to May (during seasonal high water table elevations) of each year depending on soil type. Constructed channels (agricultural drainage ditch) may be utilized to remove surface water and lower the water table as necessary for erop productions and site management.~~

a. Depth to bedrock or restrictive layers shall be a minimum of 18 inches.

b. Biosolids application shall not be made during times when the seasonal high water table of the soil is within 18 inches of the ground surface. If Natural Resources Conservation Service soil survey information regarding depth of seasonal water table is not available, the water table depth shall be determined by soil characteristics or water table observations. If the soil survey or such evidence indicates that the seasonal water table can be less than 18 inches below the average ground surface, soil borings shall be conducted within seven days prior to land application operations during periods of high water table for the soil series present to verify the actual water table depth. The use of soil borings and water table depth verification may be required for such sites from November to May (during seasonal high water table elevations) of each year depending on soil type. Constructed channels (agricultural drainage ditches) may be utilized to remove surface water and lower the water table as necessary for crop production and site management.

c. The pH of the biosolids and soil mixture shall be 6.0 or greater at the time of each biosolids application if the biosolids cadmium concentration is greater than or equal to 21 mg/kg. The soil pH must be properly tested and recorded prior to land application operations during which a pH change of one-half unit or more may occur within the zone of incorporation (i.e., use of biosolids

containing lime or other alkaline additives at 10% or more of dry solid weight).

~~d. [Soil When soil] test pH [must be greater than or equal to is less than] 5.5 [at the time of each S.U., the land shall be supplemented with lime at the recommended agronomic rate prior to or during] biosolids application if the biosolids to be land applied have not been alkaline stabilized.~~

~~[e. Soil When soil] test potassium levels [must be greater than or equal to are less than] 38 parts per million (Mehlich I analytical procedure or equivalent) [at the time of each, the land shall be supplemented with potash at the recommended agronomic rate prior to or during] biosolids application.~~

3. Management practices.

~~a. Application rates and requirements. Process design considerations shall include sludge composition, soil characteristics, climate, vegetation, cropping practices, and other pertinent factors in determining application rates. Site specific application rates should be proposed using pertinent biosolids plant available nitrogen (PAN) and crop nutrient needs (agronomic rate listed in Table 10) and shall not exceed the rates established in the nutrient management plan nor result in exceedance of the cumulative trace element loading rates (Table 8) specified in 9VAC25-32-356 [Table 2 Table 3]. Lime amended biosolids shall be applied at rates that are not expected to result in a target soil pH in the plow layer above a pH of 6.5 for soils located in the coastal plain and above a pH of 6.8 in other areas of the state. Agricultural use of treated septage shall be in accordance with these requirements (Table 12). The biosolids application rate, application timing and all other site management practices shall be restricted to the following criteria in accordance with the approved management practices plan including the nutrient management plan that may prescribe more restrictive site management practices than the following criteria:~~

~~b. Agricultural use of stabilized septage shall be in accordance with the same requirements as biosolids.~~

~~[e. Crops. For proposed use of crops or plant available nitrogen (PAN) rates (lbs/A) not stipulated in regulations promulgated pursuant to § 10.1-104.2 of the Code of Virginia, adequate yield and PAN data are to be submitted in accordance with 9VAC25-32-60 F.~~

~~(1) Soybeans. Allowable PAN rates are equivalent to the PAN recommendation for corn stipulated in regulations promulgated pursuant to § 10.1-104.2 of the Code of Virginia. For double crop or late beans planted after June 21 (of any year) allowable PAN rates are equivalent to the PAN recommendation for corn stipulated in regulations promulgated pursuant to § 10.1-104.2 of the Code of Virginia, minus 20 lbs PAN.~~

~~(2) Tallgrass hay. Application of the full PAN rate stipulated in regulations promulgated pursuant to § 10.1-104.2 of the Code of Virginia may only be applied between March 1 and September 30 in any year. Application of up to 50% of the listed PAN rate may be applied between October 1 of any year and February 28 of the following year, with remaining PAN applied after March 1 of that following year.~~

~~(3) Warm season grasses and alfalfa. From July 1 through September 14, applications to warm season grass hay and alfalfa shall only be applied at 50% of the rate stipulated in regulations promulgated pursuant to § 10.1-104.2 of the Code of Virginia. No biosolids applications shall be made to warm season grass and alfalfa between September 15 and March 15.~~

~~d. c.] Application frequency.~~

~~[(1)] For infrequent applications, Infrequent. If biosolids are applied to a field only once in a three-year period, biosolids may be applied such that the total crop needs for nitrogen (Table 10 Agronomic Rate) is not exceeded (in order to minimize the amount of nitrogen that passes below the crop root zone to actually or potentially pollute groundwater); during a one-year crop rotation period including the production and harvesting of two crops in succession within a consecutive 12-month growing season. However, the total application of biosolids shall not exceed a computed maximum loading of 15 dry tons per acre, unless a higher loading can be justified in relation to both the biosolids and the site characteristics, including the biosolids nutrient and dry solids content and the site slopes. No further applications of biosolids shall be allowed for a period of three years from the date that the agronomic rate is achieved for the crop or crops grown in the following 12 months. The infrequent application rate may be restricted (i) down to 10% of the maximum cumulative loading rate [9VAC25-32-356 Table 2) (9VAC25-32-356 Table 3)] for cadmium and lead or (ii) to account for all sources of nutrients applied to the site, including existing residuals.~~

~~(2) The infrequent application rate may be restricted: (i) down to 10% of the maximum cumulative loading rate (Table 8) for cadmium and lead (i.e., 2.0 kilograms per hectare (kg/ha) for cadmium); or (ii) to account for all sources of nutrients applied to the site, including existing residuals.~~

~~(3) The infrequent application rate may also be restricted by the lime content of the biosolids.~~

~~(4) For systems designed for frequent application of biosolids (application of the PAN requirement for a normal crop rotation more frequently than once in every three years), the previous year's applied biosolids nitrogen and mineralization rates (Table 11) and soil phosphorus levels, shall be considered in the design and proposed subsequent application rates. Acceptable~~

Regulations

nutrient management requirements shall be included in the management practices plan for all sites proposed for frequent at agronomic application rates (9VAC25-32-680).

(5) ~~[(2) Frequent. Frequent below agronomic application rate involves frequent applications of biosolids on permanent pasture or hay at less than the PAN requirement listed in Table 10. regulations promulgated pursuant to § 10.1-104.2 of the Code of Virginia. Frequent below agronomic application rates shall be calculated using one of the following options: A maximum of 70% of the nitrogen requirement of the permanent pasture or hay crop can be applied on an annual basis. The 70% application rate shall be calculated after accounting for residual nitrogen. For systems designed for frequent below agronomic rates, surface and ground water monitoring shall not be required.]~~

~~(a) A maximum of 70% of the nitrogen requirement of the permanent pasture or hay crop can be applied on an annual basis. The 70% application rate shall be calculated after accounting for the previous two years' applied biosolids nitrogen mineralization rates.~~

~~(b) A maximum of 50% of the nitrogen requirement of the permanent pasture or hay crop can be applied on an annual basis. It is not necessary to account for the previous two years' applied biosolids nitrogen mineralization rates under this option.~~

~~For systems designed for frequent below agronomic rates, surface and groundwater monitoring shall not be required. Soil phosphorus levels shall be considered in the design of proposed subsequent application rates. No application shall be made between September 15 and March 15 on warm season grasses and alfalfa.~~

~~b. Standard slopes and topography. Management practices specifying uniform application of biosolids at approved rates should be established in accordance with standard slopes. Agronomic practices and crop growth on sites with slope of not greater than 7.0% will provide acceptable protection of surface water quality during the active growing season. If biosolids are applied to site slopes greater than 7.0% during the period of November 16 of one year to March 15 of the following year certain best management practices (BMP's) should be utilized (see subdivision 3 c (1) of this subsection). Biosolids should be directly injected into soils on sites exhibiting erosion potential unless other best management practices are utilized to minimize soil erosion and the potential of nonpoint runoff. Biosolids shall not be applied to site slopes exceeding 15%. Biosolids shall be directly injected or incorporated (mixed within the normal plow layer within 48 hours) if: (i) applied on sites with less than 60% uniform residue cover (stalks, vines, stubble, etc.) within any portion of the site; or (ii) applied to soils~~

~~during periods of time soils may be subject to frequent flooding as defined by soil survey information.~~

~~e. [e. d.] Operations.~~

~~(1) Field management. The application rate of all application equipment shall be routinely measured as described in [an approved a] sludge [operations biosolids] management plan and every effort shall be made to ensure uniform application of biosolids within sites in accordance with approved maximum design loading rates. Liquid sludges biosolids shall not be applied at rates exceeding 14,000 gallons per acre, per application. Sufficient drying times shall be allowed between subsequent applications. Application vehicles should shall be suitable for use on agricultural land. Pasture and hay fields should shall be grazed or clipped to a height of approximately four and six inches, respectively, prior to biosolids application unless the biosolids can be uniformly applied so as not to mat down the vegetative cover so that the site vegetation can be clipped to a height of approximately four inches within one week of the biosolids application. Biosolids shall be applied such that uniform application is achieved. If application methods do not result in a uniform distribution of biosolids, additional operational methods shall be employed following application such as dragging with a pasture harrow, followed by clipping if required, to achieve a uniform distribution of the applied biosolids.~~

~~(2) Surface incorporation may be required on cropland by the department, or the local monitor with approval of the department, to mitigate [excessive odors malodors] when incorporation is practicable and compatible with a soil conservation plan [or contract] meeting the standards and specifications of the U.S. Department of Agriculture Natural Resources Conservation Service.~~

~~(3) Slopes above 15%. Biosolids shall not be applied to site slopes exceeding 15%. [This restriction may be waived by the department for the establishment and maintenance of perennial vegetation or based on site specific criteria and BMPs in place in the field.]~~

~~(4) Biosolids application timing and slope restrictions shall conform to criteria contained in regulations promulgated pursuant to § 10.1-104.2 of the Code of Virginia.~~

~~In accordance with the management practices plan, when biosolids are applied to site slopes greater than 7.0% between the period of November 16 of one year, and March 15 of the following year, one of the following practices shall be used to prevent runoff and soil loss:~~

~~(a) Biosolids are surface applied or subsurface injected beneath an established living crop such as hay, pasture, or timely planted small grain or cover crop;~~

(b) Biosolids are surface applied or subsurface injected so that immediately after application the crop residue still provides at least 60% soil surface coverage; or

(c) Biosolids are applied by surface application or subsurface injection and the site is operated in compliance with an existing soil conservation plan approved by the U.S.D.A. Natural Resource Conservation Service and will remain in compliance after any subsequent tillage operation to incorporate the biosolids.

In accordance with the management practices plan if site slopes exceed 5.0% up to 7.0%, biosolids can be applied by surface application or subsurface injection followed by: (i) incorporation within 48 hours of application if crop residue still provides at least 30% soil surface coverage immediately following incorporation, or (ii) ridge tilling or chisel plowing within 48 hours of application; during the period of November 16 to March 15 of the following year. The site should be chisel plowed or ridge tilled predominately along the contour so that uniform parallel ridges of four inches or greater are created that will improve soil roughness and reduce runoff. Consideration should also be given to the use of similar practices on slopes of 5.0% or less when feasible for applications during the late fall and winter

(2) Restrictions: (5) Snow. Biosolids application shall not be made during times when the seasonal high water table of the soil is within 18 inches of the ground surface. Biosolids may only be applied to snow-covered ground if the snow cover does not exceed one inch and the snow and biosolids are immediately incorporated within 24 hours of application. If snow melts during biosolids application, incorporation is not necessary. Liquid sludges may not be applied to frozen ground. Dry or dewatered sludges may be applied to frozen ground only if (i) site slopes are 5.0% or less; (ii) a 200-foot vegetative (i.e., at least 60% uniformly covered by stalks or other vegetation) buffer is maintained from surface water courses; and (iii) the entire application site has uniform soil coverage of at least 60% with stalks, vines, stubble, or other vegetation and (iv) the site soils are characterized as well drained.

In accordance with the management practices plan, when biosolids are land applied between March 15 and September 1, crop planting following biosolids application should occur within a 30 day period. When biosolids are applied to sites between September 1 and November 16, an agronomically justified crop capable of trapping plant available nitrogen such as small grain shall be planted within 45 days of the application of biosolids or prior to November 16, whichever comes first, or an established cool season grass sod or timely planted small grain crop shall be present. The crop planted should be capable of germination and significant growth before the

onset of winter so the plant is able to use available nitrogen released by the biosolids.

On sites with a high leaching index (greater than 10) as defined by the Department of Conservation and Recreation, an established cool season grass or timely planted small grain crop should be present when biosolids are applied to such sites between November 16 and December 21 in accordance with the nutrient management plan. Biosolids should not be applied any earlier than 30 days prior to spring planting on environmentally sensitive sites in accordance with the nutrient management plan.

d. [f. Buffer zones. e. Setback distances.]

(1) Setback distances. If slopes are greater than 7.0% and biosolids will be applied between November 16 and March 15, setback distances to perennial streams and other surface water bodies shall be doubled. The [location of] land application of biosolids shall not occur within the following minimum [buffer zone setback distance] requirements (Table [± 2] of this section):

[TABLE 2: MINIMUM BUFFER ZONE REQUIREMENTS			
Adjacent Features	Minimum Distances (Feet) to Land Application Area		
	Surface Application [†]	Incorporation	Winter ²⁵
Occupied dwellings	200 ft. ^{3,2,4}	200 ^{3,2,4}	200 ^{3,2,4}
Water supply wells or springs	100 ft.	100	100
Water supply reservoirs ³	400	400	400
All streams and tributaries designated as a PWS under the WQS	100	100	100
Property lines, w/o the presence of an "occupied dwelling"	50	50	50
Property lines, with the presence of an "occupied dwelling" ⁶	100 ft. ³	50 100	100
Perennial streams and other surface waters except intermittent streams	50 ft.	35	100
Intermittent streams/drainage ditches	25 ft.	25	50

Regulations

All improved roadways	10 ft.	5	10
Rock outcrops and sinkholes	25 ft.	25	25
<u>Limestone rock outcrops and sinkholes</u>	<u>50</u>	<u>50</u>	<u>50</u>
Agricultural drainage ditches with slopes equal to or less than 2.0%	10 ft.	5	10

¹Note: Not plowed or disced/disked to incorporate within 48 hours.
²The buffer to occupied dwellings may be reduced or waived upon written consent of the occupant of the dwelling.
³Buffer may be extended by the department based on documented site specific conditions.
⁴Buffer may exceed 400 feet where an evaluation by the Virginia Department of Health determines that a buffer in excess of 400 feet is necessary to prevent specific and immediate injury to the health of an individual.
²⁵Application occurs on average site slope greater than 7.0% during the time between November 16 of one year and March 15 of the following year.
⁶Property line buffers may be reduced or waived upon written consent of the adjacent property resident or landowner.

<u>as a Public Water Supply under the Water Quality Standards</u>	
<u>Surface waters without a vegetated buffer</u>	<u>100</u>
<u>Surface waters with a 35-foot vegetated buffer</u>	<u>35</u>
<u>Agricultural drainage ditches</u>	<u>10</u>
<u>All improved roadways</u>	<u>10</u>
<u>Rock outcrops</u>	<u>25</u>
<u>Open sinkholes</u>	<u>100</u>
<u>Limestone rock outcrops and closed sinkholes⁶</u>	<u>50</u>

¹The setback distance to occupied dwellings may be reduced or waived upon written consent of the occupant and landowner of the dwelling.

²The department shall grant to any landowner or resident in the vicinity of a biosolids land application site an extended setback of up to 200 feet from their property line and up to 400 feet from their occupied dwelling upon request from their physician based on medical reasons. In order for an extended setback request to be granted, the request must be submitted to the department in writing on a form provided by the department. A request must be received by the department no later than 48 hours before land application commences on the field affected by the extended setback, and communicated to the permittee no later than 24 hours before land application commences on the field affected by the extended setback. The department may extend a setback distance within 48 hours of land application if requested by the Virginia Department of Health in connection with the landowner or resident's physician.

³Setback distances may be extended beyond 400 feet where an evaluation by the Virginia Department of Health determines that a setback in excess of 400 feet is necessary to prevent specific and immediate injury to the health of an individual.

⁴The setback distance to property lines may be reduced or waived upon written consent of the landowner.

⁵Publicly accessible sites are open to the general public and routinely accommodate pedestrians and include, but are not limited to, schools, churches, hospitals, parks, nature trails, businesses open to

<u>TABLE 1</u> <u>MINIMUM SETBACK DISTANCE REQUIREMENTS</u>	
<u>Adjacent Feature</u>	<u>Minimum Setback Distance (Feet) to Land Application Area</u>
<u>Occupied dwelling</u>	<u>200^{1,2,3}</u>
<u>Odor sensitive receptors (without injection or same day incorporation)</u>	<u>400³</u>
<u>Odor sensitive receptors (with injection or same day incorporation)</u>	<u>200</u>
<u>Property lines</u>	<u>100^{2,4}</u>
<u>Property lines of publicly accessible sites⁵</u>	<u>200</u>
<u>Water supply wells or springs</u>	<u>100</u>
<u>Public water supply reservoirs</u>	<u>400</u>
<u>All segments of streams and tributaries designated</u>	<u>100</u>

the public, and sidewalks. Temporary structures, public roads or similar thoroughfares are not considered publicly accessible.

⁶A closed sinkhole does not have an open conduit to groundwater. The setback from a closed sinkhole may be reduced or waived by the department upon evaluation by a professional soil scientist.]

(2) [~~Reduced buffer setback distances. The stated buffer zones to adjacent property boundaries and drainage ditches constructed for agricultural operations may be reduced by 50% for subsurface application (includes same day incorporation) unless state or federal regulations provide more stringent requirements.] Written consent of affected landowners is required to reduce buffer distances from property lines and dwellings. In cases where more than one [~~buffer setback~~] distance is involved, the most restrictive distance governs. Buffer requirements may be increased or decreased based on either site specific features, such as agricultural drainage features and site slopes, or on biosolids application procedures demonstrating precise placement methods.~~

(3) ~~Waivers. Waivers from adjacent property residents and landowners may only be used to reduce [~~buffer setback~~] distances from occupied dwellings and property lines.~~

~~(2) (4) Extended [~~buffer~~] setback distances. The department may increase [~~buffer setback~~] requirements based on site specific features, such as agricultural drainage features and site slopes. [For applications where surface applied biosolids are not incorporated, the department (or the local monitor with approval of the department) may require as a site specific permit condition, extended buffer zone setback distances when necessary to protect odor sensitive receptors.] When necessary, buffer zone setback distances from odor sensitive receptors may be extended to 400 feet or more and no biosolids shall be applied within such extended buffer zones. In accordance with 9VAC25 32 100 and 9VAC25 32 490, the board may impose standards and requirements that are more stringent when required to protect public health and the environment, or prevent nuisance conditions from developing, either prior to or during biosolids use operations.~~

~~e. Monitoring and testing. Groundwater and surface water and soils monitoring and testing may be required by the department, or the local monitor with approval of the department for any frequent application sites (reach agronomic rate more than once in three years) for which a potential environmental or public health concern is identified by the board in accordance with this regulation (9VAC25 32 400). Groundwater monitoring and testing~~

~~should not be required for infrequent application of biosolids.~~

[~~h. f.~~] ~~Voluntary extensions of [~~buffer setback~~] distances. If a permit holder negotiates a voluntary agreement with a landowner or resident to extend [~~buffer setback~~] distances or add other more restrictive criteria than required by this regulation, the permit holder shall document the agreement in writing and provide the agreement to the department. Voluntary [~~buffer setback~~] increases or other management criteria will not become an enforceable part of the land application permit unless the permit holder modifies the [~~operations biosolids~~] management plan to include the additional restriction.~~

[~~i. g.~~] ~~Extension of [~~buffer setback~~] distances with phosphorus index. If the application rate included in a nutrient management plan for a biosolids land application site is dependent upon an extended setback distance calculated using the phosphorus index, the phosphorus index calculations shall be included in the nutrient management plan. The extended setback distance shall be an enforceable part of the permit.~~

C. Forestland (Silviculture). Silvicultural use includes application of biosolids to [~~commercial~~] timber and fiber production land, as well as federal and state forests. The forestland may be recently cleared and planted, young plantations (two-year-old to five-year-old trees), or established forest stands.

1. ~~Sludge Biosolids standards. Refer to [9VAC25 32 590 the standards] and 9VAC25 32 660 of this Article article.~~

2. Site suitability.

a. ~~Site suitability requirements should shall conform to subdivision A 2 of this section the requirements contained in subdivision B 2 of this section.~~

b. ~~The Notwithstanding the requirements of [~~subsection subdivision~~] B 2 of this section the soil pH should shall be managed at the natural soil pH for the types of trees proposed for growth.~~

c. ~~Notwithstanding the requirements of [~~subsection subdivision~~] B 2 of this section the soil test potassium level is not required to be at a minimum level at the time of biosolids application.~~

3. Management practices.

a. Application rates. Biosolids application rates shall be in accordance with the [~~operations biosolids~~] management [~~practices~~] plan ~~and. The [~~operations biosolids~~] management plan shall include~~ information provided by the Virginia Department of Forestry.

b. Operations.

(1) Field management.

(a) High pressure spray shall not be utilized if public activity is occurring within 1,500 feet downwind of the application site. Public access to the site shall be

Regulations

~~adequately limited or~~ controlled following application (Article 3 (9VAC25-32-490 et seq.) of this part) in accordance with Article 3 (9VAC25-32-490 et seq.) of this part.

~~(b) The operations should only proceed when the wind velocity is less than or equal to 15 miles per hour. When high pressure spray is used windless conditions are preferred for such operations.~~

~~(c)~~ (b) Biosolids application vehicles ~~should~~ shall have adequate ground clearance to be suitable for silvicultural field use.

~~(d)~~ (c) Application scheduling ~~should~~ included in the [operations biosolids] management [practices] plan shall take into account ~~high~~ rainfall periods and periods of freezing conditions.

~~(e)~~ (d) Monitoring requirements shall be site specific and may include [groundwater ~~ground water~~], surface water or soils, for frequent application sites.

~~(2) [Buffer zones. Buffer zones Setbacks. Setbacks] should shall~~ conform to those for agricultural utilization. Refer to [~~Table 2~~ Table 1] of this section.

D. Reclamation of disturbed land. ~~Biosolids applied at rates exceeding the agronomic rate may reclaim disturbed land in one or more of the following ways: (i) surface or underground mining operations, (ii) the deposition of ore processing wastes, (iii) deposition of dredge spoils or fly ash in construction areas such as roads and borrow pits. Reclamation of disturbed land is within the jurisdiction of the Virginia Department of Mines, Minerals and Energy. That department should be contacted concerning issuance of a permit for these operations. The land reclamation management practices plan should be prepared with the assistance of the Virginia Department of Conservation and Recreation, the Soil Conservation Service and the Virginia Cooperative Extension Service.~~

1. ~~Sludge~~ Biosolids standards. Refer to the standards of this article.

2. Site suitability. Site suitability requirements ~~should~~ shall conform to ~~subdivision A 2 of this section~~ the requirements contained in subdivision B 2 of this section. Exceptions may be considered on a case-by-case basis.

3. Management practices.

a. Application rates. The biosolids application rates shall be established in the [nutrient biosolids] management practices plan through recommendations provided by appropriate agencies including in consultation with the Virginia Department of Mines, Minerals and Energy [and,] the Virginia Department of Conservation and Recreation [; and the] appropriate faculty of the [Department of Crop and Soil Environmental Sciences of the Virginia Polytechnic Institute and State University.] The nutrient management plan shall be approved by the Department of Conservation and

Recreation prior to permit issuance [where land application is proposed at greater than agronomic rates].

b. Vegetation selection. The land ~~should~~ shall be seeded with grass and legumes even when reforested ~~in order to help prevent erosion and utilize available plant nitrogen.~~ The [biosolids] management [practices] plan shall include information on the seeding mixture and a detailed seeding schedule.

c. Operations.

(1) The soil pH ~~should~~ shall be maintained at 6.0 or above if the cadmium level in the biosolids applied is at or above 21 mg/kg. during the first year after the initial application. Soil samples should be analyzed by a qualified laboratory. The application rate shall be limited by the most restrictive cumulative trace element loading (~~Table 8~~) [(~~Table 2 of this section~~). (9VAC25-32-356 Table 3).]

(2) Surface material ~~should~~ shall be turned or worked prior to the surface application of liquid biosolids, ~~to minimize potential for runoff, since solids in liquid sludge can clog soil surface pores.~~

(3) Unless the applied biosolids are determined to be Class A or have been documented as subjected to Class I treatment, crops intended for direct human consumption shall not be grown for a period of three years following the date of the last ~~sludge~~ biosolids application ~~unless the crop is tested to verify that the crop is not contaminated.~~ No animals whose products are intended for human consumption may graze the site or obtain feed from the site for a period of six months following the date of the last biosolids application, ~~unless representative samples of the animal products are tested after grazing and prior to marketing to verify that they are not contaminated.~~

9VAC25-32-570. Distribution and marketing.

A. Exceptional quality. Distribution or marketing provides for the sale or distribution of exceptional quality biosolids or mixtures of ~~Class I treated~~ exceptional quality biosolids with other materials such that the mixture achieves the Class A pathogen control ~~standard,~~ vector attraction reduction and pollutant control standards. Distribution or marketing of ~~Class I treated~~ Class A biosolids that have been mixed with inert materials may be approved on a case-by-case basis. ~~Inert materials shall not contain pathogens or attract vectors.~~ Use of such mixtures for agricultural purposes ~~should~~ shall be evaluated through proper testing or research programs designed to ~~access~~ assess the suitability of the material for such use. Exceptional quality biosolids marketed as fertilizers or soil conditioners must ~~be registered with the Virginia Department of Agriculture and Consumer Services. The permit applicant shall obtain such registration prior to issuance of a permit by the board for residential, agricultural, reclamation or silvicultural use.~~ meet the following conditions:

1. The biosolids product must be registered with the Virginia Department of Agriculture and Consumer Services in accordance with [~~regulations promulgated under § 3.2-3601~~ the provisions of § 3.2-3607] of the Code of Virginia. [~~The permit applicant shall obtain such registration prior to issuance of a permit by the board.~~]

1. Because of the high potential for public contact with distributed and marketed sludge or sludge products, only

2. The biosolids product must be processed to meet criteria specified for Class I treatment process sequences designed to eliminate or further reduce pathogens (PFRP) shall be sold or given away for application to land Class A pathogen requirements as specified in 9VAC25-32-675 A. In addition, the biosolids must meet vector attraction reduction requirements, and other quality standards (Table 8) as required for the intended use.

3. The biosolids product must meet one of the vector attraction reduction requirements as specified in 9VAC25-32-685 B 1 through B 8.

4. The biosolids product must meet the ceiling concentrations specified in 9VAC25-32-356 - [~~Table 1 Table 2~~].

5. The biosolids product must meet the pollutant concentrations specified in 9VAC25-32-356 - [~~Table 3 Table 4~~].

6. Additional parameters [may be required for screening purposes] such as [~~the~~] organic chemicals [~~listed in Table 1 of this section may be required for screening purposes as well as;~~] aluminum (mg/kg), water soluble boron (mg/kg), calcium (mg/kg), chlorides (mg/l), manganese (mg/kg), [~~sulfates sulfur~~] (mg/kg), and those pollutants for which removal credits are granted.

[TABLE 1 ORGANIC CHEMICAL TESTING MAY BE REQUIRED TO IDENTIFY AN EXCEPTIONAL QUALITY BIOSOLIDS
Organic chemicals
Aldrin/dieldrin (total)
Benzo (a) pyrene
Chlordane
DDT/DDE/DDD (total)*
Dimethyl nitrosamine
Heptachlor
Hexachlorobenzene
Hexachlorobutadiene
Lindane
Polychlorinated biphenols

Toxaphene
Trichloroethylene
*Note:
DDT 2,2 Bis (chlorophenyl) 1,1,1
Trichloroethane
DDE 1,1 Bis (chlorophenyl) 2,2 Dichloroethane
DDD 1,1 Bis (chlorophenyl) 2,2
Dichloroethane]

2. B. Bulk distribution. Exceptional quality biosolids may be distributed and marketed in either bulk amounts (unpacked) or as a bagged product. For purposes of this regulation, a bulk use quantity of biosolids will be defined as a volume of that sludge product containing 15 dry tons or more of sewage sludge. Application of bulk use quantities of exceptional quality biosolids to home vegetable gardens shall not exceed an equivalent annual loading rate of approximately one pound dry weight of biosolids per square foot (garden products may constitute a significant portion of a family diet and the amount of applied biosolids cannot be specifically controlled as in agricultural use). Exceptional quality biosolids can ideally be used as soil amendments for horticulture and landscaping purposes such as The following requirements shall apply to distribution and marketing of biosolids products:

- a. Use in potting soil mixes;
- b. Use for seed beds, for establishment of grass and other vegetation and for topdressing of existing lawns and landscape vegetation.

1. Any permit holder who distributes or markets exceptional quality biosolids shall [~~maintain records as required by regulations promulgated under § 3.2-3601 of the Code of Virginia and make the records comply with the reporting requirements of §§ 3.2-3609 and 3.2-3610 of the Code of Virginia. The records shall be maintained for five years and made] available to the department upon request.~~

2. Bulk quantities of exceptional quality biosolids shall be land applied in accordance with a nutrient management plan prepared by a certified nutrient management planner as stipulated in regulations promulgated pursuant to § 10.1-104.2 of the Code of Virginia, except under the following conditions:

- a. The percent solids of the biosolids is equal to or greater than 90% based on moisture content and total solids, or
- b. [~~The percent solids of a blended product derived from biosolids is equal to or greater than 40% based on moisture content and total solids and achieves a carbon to nitrogen ratio of at least 25:1~~ A blended product derived from biosolids is utilized for a purpose other than land application at agricultural operations] .

Regulations

3. Within 30 days after land application at the site has commenced, the permit holder shall provide a copy of the plan to [~~the department,~~] the [~~farmer farm~~] operator of the site [~~;~~] and the Department of Conservation and Recreation [~~regional office~~].

3. C. Approval of biosolids sources. Only exceptional quality biosolids produced from an approved a sludge processing facility approved by the board can be distributed and marketed. Biosolids sold for use as soil amendments or fertilizers must be registered with the Virginia Department of Agriculture and Consumer Services. Approved sludge processing facilities are those facilities constructed and operated in compliance with required permits. Approved methods of Class I processing for biosolids for distribution or marketing include, but may not be limited to, the methods described in this article.

B. Permits. Any owner who proposes to distribute or market exceptional quality biosolids or materials derived from Class I biosolids (distributor), including soil additives or compost in bulk use quantities, shall be required to obtain a written approval issued by the board. The derived material shall achieve acceptable vector attraction reduction standards and contain acceptable levels of solids and pollutant concentrations in accordance with this regulation. A permit for distribution or marketing is not required provided that an operation permit has been issued for land application of the processed material as part of either an approved sludge management plan (12VAC5-585-140 H) or an approved management practices plan (12VAC5-585-240). Approval of the distribution of bulk use quantities of exceptional quality biosolids is not required for a holder of a valid permit that authorizes distribution in bulk use quantities. All requests for bulk use approval shall be directed initially to the appropriate regional office of the department. The Virginia Department of Health, the Virginia Department of Agriculture and Consumer Services and the Virginia Department of Conservation and Recreation may participate in the review of such permits involving land application. A permit for distribution of bulk use quantities of biosolids will require the submittal and review of an acceptable distribution information sheet as described in this regulation. The approval of a distribution information sheet for bulk use quantities of exceptional quality biosolids will be issued in the form of a letter of approval of such use by the department's regional offices.

The permittee shall maintain records on the sludge processing facility operation, maintenance and laboratory testing. Records shall be maintained for all samples to include the following: (i) the date and time of sampling, (ii) the sampling methods used, (iii) the date analyses were performed, (iv) the identity of the individual obtaining each sample and the analysts, and (v) the results of all required analyses and measurements. The records shall include all data and calculations used and shall be available to the department

for inspections at reasonable times. All required records shall be kept for a minimum of five years.

C. D. Information furnished to all users. Biosolids distributed for public use in Virginia shall have proper identification of the producer and a description of the product including an acceptable statement of quality based on representative analytical testing. This information shall be provided by the owner in either brochures for bulk distribution or by proper labeling on bagged material. Labeling requirements ~~should~~ shall be addressed in [a ~~an~~ operations biosolids] management plan or in the operation and maintenance manual for the processing facility. Either a label shall be affixed to the bag or other container in which exceptional quality biosolids is sold or given away for application to the land, or an information sheet shall be provided to the person who receives exceptional quality biosolids. The label or information sheet shall contain the following information:

1. The name and address of the person who prepared the exceptional quality biosolids;
2. A statement that application of the exceptional quality biosolids to the land is prohibited except in accordance with the instructions on the label or information sheet;
3. The annual whole sludge application rate for the biosolids that does not cause any of the annual pollutant loading rates in [~~Table 4~~ Table 5] of 9VAC25-32-356 to be exceeded; and
4. Information required in accordance with regulations promulgated under § 3.2-3601 of the Code of Virginia [and with the labeling provisions of § 3.2-3611 of the Code of Virginia].

Information provided to users of marketed or distributed biosolids should note the following:

- (i) the nutrient content,
 - (ii) the acceptable land application rates,
 - (iii) the CCE value,
- the pH,
- (iv) to follow the stated directions for use, and
 - (v) that for any uses not specified the user should contact the distributor at a listed address or telecommunications number.

D. Distribution information. Distribution information should be maintained by the sludge processing facility owner or holder of a permit for distribution or marketing (distributor) and completed by any single biosolids distributor or user receiving bulk use quantities of marketed or distributed biosolids of more than 50 cubic yards during a period of 24 consecutive hours or less. Copies of this information should be maintained by the sludge processing facility or distributor and be made available upon request by the department. These records should include the following information, as a minimum:

1. Date;
2. Name, address, and phone number of user;
3. Amount of exceptional quality biosolids obtained; ~~and~~
4. Location and property owner where biosolids are being used;
5. Size of area where biosolids are spread;
6. Proximity of site to closest river or water supply source; and
7. Description of site uses.

~~Only the information listed in subdivisions 1 through 4 of this subsection shall be necessary for submission by a biosolids distributor.~~

The department reserves the right to prohibit the distribution of bulk use quantities of biosolids when it appears that such distribution is being accomplished in such a manner so as to circumvent the foregoing requirements.

~~E. Other uses. The use of a nonhazardous sewage sludge product, such as incinerator ash, will be evaluated on a case-by-case basis as provided for by this regulation.~~

E. Recordkeeping.

1. The person who prepares exceptional quality biosolids shall develop the following information and shall retain the information for five years:

- a. The concentration of each pollutant listed in [~~Table 3~~ Table 4] of 9VAC25-32-356 in the biosolids;
- b. The following certification statement:

"I certify [,] under penalty of law, that the information that will be used to determine compliance with the Class A pathogen requirements in 9VAC25-32-675 A and the vector attraction reduction requirement in (insert one of the vector attraction reduction requirements in 9VAC25-32-685 B 1 through B 8) was prepared under my direction and supervision in accordance with the system designed to ensure that qualified personnel properly gather and evaluate this information. I am aware that there are significant penalties for false certification including the possibility of fine and imprisonment.";

- c. A description of how the Class A pathogen requirements in 9VAC25-32-675 A are met; and
- d. A description of how one of the vector attraction reduction requirements in 9VAC25-32-685 B 1 through B 8 is met.

2. The person who derives the material that meets the criteria of exceptional quality biosolids shall develop the following information and shall retain the information for five years:

- a. The concentration of each pollutant listed in [~~Table 3~~ Table 4] of 9VAC25-32-356 in the material;
- b. The following certification statement:

"I certify, under penalty of law, that the information that will be used to determine compliance with the Class A pathogen requirements in 9VAC25-32-675 A and the vector attraction reduction requirement in (insert one of the vector attraction reduction requirements in 9VAC25-32-685 B 1 through B 8) was prepared under my direction and supervision in accordance with the system designed to ensure that qualified personnel properly gather and evaluate this information. I am aware that there are significant penalties for false certification including the possibility of fine and imprisonment.";

c. A description of how the Class A pathogen requirements in 9VAC25-32-675 A are met; and

d. A description of how one of the vector attraction reduction requirements in 9VAC25-32-685 B 1 through B 8 is met.

3. If the requirements in 9VAC25-32-356 [~~A-4 b~~ B 4 b] are met when biosolids is sold or given away in a bag or other container for application to the land, the person who prepares the biosolids that is sold or given away in a bag or other container shall develop the following information and shall retain the information for five years:

a. The annual whole sludge application rate for the biosolids that does not cause the annual pollutant loading rates in [~~Table 4~~ Table 5] of 9VAC25-32-356 to be exceeded;

b. The concentration of each pollutant listed in [~~Table 4~~ Table 5] of 9VAC25-32-356 in the biosolids;

c. The following certification statement:

"I certify, under penalty of law, that the information that will be used to determine compliance with the management [~~practice~~ practices] in 9VAC25-32-570 E and F, the Class A pathogen requirement in 9VAC25-32-675 A, and the vector attraction reduction requirement in (insert one of the vector attraction reduction requirements in 9VAC25-32-685 B 1 through B 8 []) was prepared under my direction and supervision in accordance with the system designed to ensure that qualified personnel properly gather and evaluate this information. I am aware that there are significant penalties for false certification including the possibility of fine and imprisonment.";

d. A description of how the Class A pathogen requirements in 9VAC25-32-675 A are met; and

e. A description of how one of the vector attraction reduction requirements in 9VAC25-32-685 B 1 through B 8 is met.

F. An annual report shall be submitted to the department that includes the following information:

1. Total amount in dry tons of exceptional quality biosolids distributed in a bag or other container per year;

2. Total amount in dry tons of exceptional quality biosolids distributed in bulk; and

Regulations

3. Total amount in dry tons of exceptional quality biosolids distributed from each approved source.

9VAC25-32-580. Sludge disposal.

Permits for sludge disposal practices will be issued through other state and federal regulations and are not subject to this regulation. Such practices may include:

1. Incineration. Emission quality control requirements will be established in accordance with state and federal regulations. The generated ash is required to be properly managed in accordance with local, state and federal regulations. Applicable regulatory requirements in addition to this regulation may involve permits issued by the appropriate state and federal agencies. [~~Buffer separation~~ Setback distance] requirements will be established on a site specific basis in accordance with the applicable regulations.

2. Landfill. Management of stabilized sludge suitable for topdressing of completed landfill areas will be subject to state and federal regulations. Codisposal of sludge within municipal solid waste landfills is subject to state and federal regulation. Codisposal requirements have included:

- a. Stabilization treatment of sludges.
- b. Dewatering of sludges by methods designed to achieve a suspended solids level of 20% or more, or a treated sludge sample passes the paint filter test standards for free water.
- c. A nonhazardous declaration from the owner.

3. Lagooning (surface disposal). When these facilities are closed by burying the wastes in place, they may be considered to be surface disposal sites. A closure plan shall be provided to the appropriate agencies.

4. Dedicated sites. The primary purpose of surface disposal sites is to allow frequent long-term sludge application at a single location at amounts that exceed agronomic rates but not for the purpose of reclaiming disturbed soils. Sludge disposal operations on dedicated sites will be subject to local, state and federal regulations including site management practices. Permits will be issued through state and federal regulations to protect public health and the quality of state waters. Any dedicated site may be subject to local zoning requirements and may be recorded as a dedicated site in the appropriate circuit court deed book (Table A-1) by filing a Sludge Disposal Site Dedication Form.

9VAC25-32-590. ~~Standards for agricultural use.~~ (Repealed.)

~~A. Standards for agricultural use of sewage sludge as biosolids have been established such that the concentrations of sludge contaminants released to the environment will not exceed the human health and environmental quality criterion for the relevant exposure pathways.~~

~~B. Agricultural use standards involve regulation of the following:~~

- ~~1. Sludge characteristics as determined from sampling and testing as well as control of sewer use.~~
- ~~2. Sludge treatment (stabilization) in relation to process design and operational controls (Table 3).~~
- ~~3. Site management in relation to land application of biosolids for agronomic use, including (i) operational methods, (ii) access restrictions, and (iii) buffer restrictions.~~
- ~~4. Crop management in relation to land application of biosolids and crop rotation, including (i) application rate determinations, and (ii) crop use restrictions.~~
- ~~5. Standards for biosolids characteristics including (i) nutrient concentrations, (ii) heavy metal concentrations, (iii) organic chemical concentrations, and (iv) lime content/pH characteristics.~~
- ~~6. Standards for processing biosolids involving treatment process sequences for (i) pathogen reduction treatment and (ii) reduction of organic matter to minimize odors and reduce vector attraction.~~

9VAC25-32-600. Biosolids characteristics; nutrients; trace elements; organic chemicals. (Repealed.)

~~A. The primary agronomic value of biosolids, the nutrient content, shall be established prior to agricultural use. The applied nitrogen and phosphorous content of biosolids shall be limited to amounts established to support crop growth. Nitrate nitrogen developed as a result of biosolids application shall be controlled in order not to accumulate in groundwater as a pollutant. Thus, the amount of biosolids applied to land shall be restricted based on the nitrogen requirements of the crop grown on the amended site immediately following application (agronomic rate). In addition, soil erosion and site runoff should not result in phosphorous pollution of surface waters as a result of surface application of biosolids. The results of approved groundwater monitoring programs may be utilized to verify frequent application rates.~~

~~B. The heavy metal content of biosolids may restrict the application rate below the agronomic rate. However, municipal biosolids would not normally contain excessive heavy metal concentrations unless a significant amount of a high metal content wastewater without pretreatment is routinely discharged into the municipal system. If a biosolid contains heavy metal concentrations below the ceiling values listed in Table 7, or is processed and evaluated as exceptional quality biosolids, the application rate for agricultural use shall be unrestricted up to the agronomic rate for infrequent applications. The accumulated amount of trace elements can restrict the application rate for frequent applications of biosolids.~~

~~C. Municipal biosolids can contain synthetic organic chemicals from industrial wastewater contributions and disposal of household chemicals and pesticides. Municipal~~

biosolids typically contain very low levels of these compounds; however, biosolids may be required to be tested for certain toxic organic compounds prior to agricultural use (Table 12). If performed and validated, these test results shall be utilized to evaluate the maximum allowable annual loading rate for the tested biosolids. If analytical test results verify that biosolids contains levels of organic chemicals exceeding concentration limits incorporated in federal regulations or standards, appropriate restrictions shall be imposed for agricultural use of that biosolid.

9VAC25-32-610. Biosolids treatment. (Repealed.)

A. Stabilization. Biosolids treatment processes are primarily designed to increase the solids content of the biosolids by separation and removal of liquid and are designed to stabilize the solid fraction through biochemical conversions that inactivate pathogens and reduce vector attraction characteristics and the potential for odor production. Such treatment should be designed to improve the characteristics of the biosolids for a particular use/disposal practice, increase the economic viability of using a particular practice and reduce the potential for public health, environmental and nuisance problems.

B. Class I treatment. Class I treatment may be achieved by process sequences to further reduce (PFRP) or eliminate pathogens, i.e., Class A pathogen control. Class I treatment methods reduce all pathogens potentially contained in biosolids or septage to a level below specified limits (Table 3). Class A microbiological standards and an acceptable solids content shall be achieved at the time biosolids are used or prepared for distribution or marketing in accordance with the appropriate management practices specified in this regulation. Class I treatment processes should include one or more of the following operations:

1. Heat treatment. The temperature of the biosolids that is used or disposed is maintained at a specific value for a specified period of time:

a. When the percent solids of the biosolids is 7.0% or higher, the temperature of the biosolids shall be 50°C or higher; the time period shall be 20 minutes or longer; and the temperature and time period shall be determined using equation B 1, except when small particles of biosolids are heated by either warmed gases or an immiscible liquid.

Equation B 1: $D1 = (131,700,000) / 10(\exp 0.1400(t))$

Where,

D1 = time in days that biosolids temperature is t or more

t = Biosolids temperature in degrees Celsius.

exp = exponent or power that Base 10 is raised to.

b. When the percent solids of the biosolids is 7.0% or higher and small particles of biosolids are heated by either warmed gases or an immiscible liquid, the temperature of the biosolids shall be 50°C or higher; the time period shall be 15 seconds or longer; and the

temperature and time period shall be determined using equation B 1.

c. When the percent solids of the biosolids is less than 7.0% and the time period is at least 15 seconds, but less than 30 minutes, the temperature and time period shall be determined using equation B 1.

d. When the percent solids of the biosolids is less than 7.0% the temperature of the biosolids is 50°C or higher; and time period is 30 minutes or longer, the temperature and time period shall be determined using equation B 2.

Equation B 2: $D2 = (50,070,000) / 10(\exp 0.1400(t))$

Where,

D2 = time in days that biosolids temperature is t or more

t = Biosolids temperature in degrees Celsius.

e. The temperature of the biosolids is maintained at 70°C or higher for a time period of 30 minutes or longer (Pasteurization).

2. Heat drying. A process wherein dewatered biosolids cake is dried by direct or indirect contact with hot gases and the biosolids moisture content is reduced to 10% or lower. Direct drying is achieved when the biosolids particles reach temperatures of 80°C or higher. Indirect drying may involve the temperature of the gas stream measured at the point where the gas stream leaves the dryer. Indirect drying may be achieved when the wetbulb temperature of the gas stream leaving the dryer is in excess of 80°C or the biosolids particles reach temperatures of 80°C or higher.

3. Thermophilic composting. A process using the within-vessel composting method that maintains a treated biosolids temperature of 55°C or greater for three days. A process using the static aerated pile composting method that maintains a treated biosolids temperature of 55°C or greater for three days. A process using the windrow composting method that maintains a treated biosolids temperature at 55°C or greater for at least 15 days during the composting period, and during the indicated high temperature period, there is a minimum of five turnings of the windrow. Operating temperatures are measured at the depth of 30 cm from the surface of the compost mixture. As thermophilic composting processes are less efficient in destroying pathogens than other disinfection processes an additional storage of processed compost up to 30 days or more may be necessary to achieve an adequate level of vector attraction reduction as verified by testing prior to final disposition (Table 3).

4. Thermophilic aerobic digestion. Liquid biosolids consisting of 50% or more waste biological liquid by dry weight, is agitated with air or oxygen to maintain one mg/l or more dissolved oxygen at mid depth, during a mean cell residence time of 10 days or more at 55°C or more.

5. Alkaline (PFRP) stabilization. Thorough blending of an alkaline additive to digested biosolids in sufficient

Regulations

quantities to produce a mixture pH of 12 or more for a period of 72 hours or more with one of the following: (i) mixture temperature of 55°C for a minimum period of 12 hours, or (ii) mixture temperature of 70°C or more for a minimum period of 30 minutes or more. Such treatment may be followed by storage for an acceptable period of time to dry the mixture to an adequate dry solids content. Alkaline addition to undigested biosolids will be considered on a case by case basis with extensive monitoring used to verify the level of pathogen control achieved.

6. Chlorine oxidation. A process of introducing high doses of chlorine (1,000 mg/l to 3,000 mg/l) into the biosolids stream under low pressure (30 psig or more) producing a biosolids pH of four or less in order to achieve Class A microbiological standards (Table 3), followed by acceptable drying to achieve a suspended solids content of 30% or more.

7. Alternative equivalent stabilization processes. The process operating parameters for alternative equivalent stabilization processes (PFRP) should be addressed, case by case, based on department evaluation of the results of adequate monitoring and testing programs (Table 3), with input from the USEPA staff, i.e., the Pathogen Equivalency Committee.

C. Class II treatment. Class II treatment may be achieved by process sequences to significantly reduce pathogens (PSRP), i.e., Class B pathogen control. Class II treatment methods reduce bacteria (fecal coliform, fecal streptococci, enterococci) found in the treated biosolids or septage 1 log or more (32 fold) below the densities found in the raw biosolids to achieve a density of (6.3 log₁₀ per gram of total solids or less (Table 3)). Class B microbiological standards shall be achieved at the time the biosolids are removed and transported for land application in accordance with the management practices specified. Class II treatment processes may include one or more of the following operations:

1. Anaerobic digestion. A process whereby biosolids are maintained in an anaerobic environment for a mean cell residence period ranging from 60 days at 20°C to 15 days at 35°C.

2. Aerobic digestion. A process of agitating biosolids with air or oxygen to maintain aerobic conditions for a mean cell residence period ranging from 60 days at 15°C to 40 days at 20°C.

3. Low temperature composting. A process using the within vessel, aerated static pile or windrow composting methods, whereby the temperature of treated biosolids is maintained at a minimum of 40°C for five days. For four hours during this period the operating temperature of the treated biosolids exceeds 55°C. Additional storage of processed compost for 30 days or more may be necessary to provide the necessary level of vector attraction reduction prior to final disposition.

4. Alkaline (PSRP) stabilization. A process where sufficient alkaline additive is blended with unstabilized biosolids to produce a minimum mixture pH of 12 after two hours of contact and a pH of 11.5 or more for 22 additional hours or more, with storage for a period sufficient to produce an acceptable dry solids content as necessary for the method of final disposition.

5. Air drying. Biosolids treated by methods similar to those listed above, but not meeting Class II treatment standards are dried on sand beds or in basins with underdrains for a minimum period of three months, during which time the ambient daily temperature exceeds 0°C and dried biosolids are produced.

D. Additional treatment methods to provide disinfection of treated biosolids. Pathogen treatment processes may be enhanced by providing additional treatment methods to eliminate parasitic worms and ova (EH process sequence). Any of the processes listed below, if added to stabilization processes described previously, will further lower pathogens. Because these processes when used alone do not reduce nuisance odors and the attraction of vectors, they are considered to be supplementary to typical stabilization and pathogen treatment processes.

1. Beta ray irradiation. A process involving the irradiation of biosolids with beta rays at dosages of at least one megarad at 20°C.

2. Gamma ray irradiation. A process involving the irradiation of biosolids with gamma rays from certain isotopes, such as 60Cobalt and 137Cesium, at dosages of at least 1.0 megarad at 20°C.

E. Vector attraction reduction parameters. One of the appropriate vector attraction reduction requirements shall be achieved and Class A or B pathogen control obtained when bulk biosolids are applied to agricultural land, forest, a public contact site, reclamation site, lawn or home gardens. One of the appropriate vector attraction reduction requirements shall be met when Class A biosolids are sold or given away in a bag or other container for application to the land. The following operational methods will achieve the necessary vector attraction reduction requirements:

1. The mass of volatile solids in the biosolids shall be reduced by a minimum of 38% (see calculation procedures in "Environmental Regulations and Technology Control of Pathogens and Vector Attraction in Sewage Sludge," EPA-625/R-92/013, July 2003, U.S. Environmental Protection Agency, Cincinnati, Ohio 45268).

2. When the 38% volatile solids reduction cannot be met for an anaerobically digested biosolid, vector attraction reduction can be demonstrated by digesting a portion of the originally digested biosolids anaerobically in the laboratory in a bench scale unit for 40 additional days at a temperature between 30°C and 37°C. When at the end of the 40 days, the volatile solids in the biosolids at the beginning of that period is reduced by less than 17%;

~~adequate vector attraction reduction is considered demonstrated for the originally digested biosolids.~~

~~3. When the 38% volatile solids reduction requirement cannot be met for an aerobically digested biosolid, vector attraction reduction can be demonstrated by digesting a portion of the originally digested biosolids that has a percent solids of 2.0% or less aerobically in the laboratory in a bench scale unit for 30 additional days at 20°C. When at the end of the 30 days, the volatile solids in the biosolids at the beginning of that period is reduced by less than 15%, adequate vector attraction reduction is considered demonstrated for the originally digested biosolids.~~

~~4. The specific oxygen uptake rate (SOUR) for biosolids treated in a Class II or better aerobic process shall be equal to or less than 1.5 milligrams of oxygen per hour per gram of total solids (dry weight basis) at a temperature of 20°C.~~

~~5. Biosolids shall be treated in a Class II or better aerobic process for 14 days or longer. During that time, the temperature of the biosolids shall be higher than 40°C and the average temperature of the biosolids shall be higher than 45°C.~~

~~6. The pH of treated biosolids shall be raised to 12 or higher by alkaline addition and, without the addition of more alkaline material, shall remain at 12 or higher for two hours and then at 11.5 or higher for an additional 22 hours. Alkaline stabilization of untreated biosolids shall be evaluated on a case by case basis.~~

~~7. The percent solids of treated biosolids that does not contain unstabilized solids generated in a primary wastewater treatment process shall be equal to or greater than 75% based on the moisture content and total solids prior to mixing with other materials.~~

~~8. The percent solids of treated biosolids that contains unstabilized solids generated in a primary wastewater treatment process shall be equal to or greater than 90% based on the moisture content and total solids prior to mixing with other materials.~~

~~9. For biosolids that are surface applied and incorporated, or injected, below the surface of the land:~~

~~a. No significant amount of the biosolids shall be present on the land surface within one hour after the biosolids are injected.~~

~~b. When the biosolids that are injected below the surface of the land are Class A with respect to pathogens, the biosolids shall be injected below the land surface within eight hours after being discharged from the pathogen treatment process.~~

~~c. Biosolids applied to the land surface shall be incorporated into the soil within six hours after application to or placement on the land.~~

~~d. When biosolids that are incorporated into the soil are Class A with respect to pathogens, the biosolids shall be~~

~~applied to or placed on the land within eight hours after being discharged from the pathogen treatment process.~~

~~10. The pH of untreated domestic septage applied to land shall be raised to 12 or higher by alkaline addition and, without the addition of more alkaline material, shall remain at 12 or higher for 30 minutes prior to application.~~

9VAC25-32-620. Site access time restrictions. (Repealed.)

~~A. Unrestricted access (UA). Biosolids that have undergone Class I treatment to achieve Class A pathogen control may be applied or incorporated into the soil of agricultural lands and immediate public access is permitted. A waiting period is required up to 30 days following application (to allow adhering biosolids to be washed from the foliar portion of the plants by precipitation). This waiting period is required before (i) crops are harvested for human consumption, or (ii) domestic animals are allowed to graze on the site.~~

~~B. Restricted access (RA). Following application or incorporation of biosolids that have undergone Class II treatment to achieve Class B pathogen control public access and crop management shall be restricted as follows: (i) access to any site with a high potential for contact with the ground surface (public use) by the general public shall be controlled for a minimum time period of one year, (ii) access to agricultural sites and other sites with a low potential for public exposure shall be controlled for 30 days, (iii) food crops with harvested parts that touch the biosolids/soil mixture and are not totally above the land surface shall not be harvested for 14 months, (iv) food crops with harvested parts below the surface of the land shall not be harvested for 20 months following application, when the biosolids remain on the land surface for four months or longer prior to incorporation into the soil, (v) food crops with subsurface harvested parts shall not be harvested for 38 months following application, when the biosolids remain on the land surface less than four months prior to incorporation, (vi) feeding of harvested crops to animals shall not take place for a total of one month following surface application (two months for lactating dairy livestock), (vii) grazing by animals whose products will or will not be consumed by humans is prevented for at least 30 days (60 days for lactating dairy livestock), and (viii) harvesting turf grass for placement on land with a high potential for public exposure or a lawn is prevented for 12 months.~~

~~C. Modified Access (MA). If a biosolids processing sequence is used to treat PSRP or PSLP biosolids that eliminates or inactivates helminth eggs (EH), public use access restrictions are reduced to six and eight months respectively, which shall include two summer months. A summary listing of access restrictions is presented in Table 9.~~

9VAC25-32-630. Biosolids management for nitrogen loading. (Repealed.)

~~A. Crop uptake guidelines. 9VAC25-32-560 B-3 states that application rates shall be approved by the board and that nitrogenous substances are often the limiting factoring~~

Regulations

determining these application rates. The applicant is responsible for providing site specific biosolids loading rates on a field by field basis. In cases where nitrogen is the rate limiting constituent, such rates may be justified by determining the predominant soil type in a field and then correlating the appropriate soil productivity group and nitrogen requirement for the proposed crop. Soil test recommendations developed through the Virginia Polytechnic Institute and State University or the Virginia Water Conservation, Department of Conservation and Recreation may be used for such purposes. Table 10 summarizes the correlation between nitrogen requirement and productivity class for several crops grown and harvested in Virginia. The applicant may also justify site specific loading rates by documenting historic crop yield records (average of three highest yields in five years of record) or by written verifications from the Virginia Polytechnic Institute and State University, the Cooperative Extension Service or Department of Conservation and Recreation Nutrient Management Specialist. Written verification shall accompany a request for higher yield goals than those posted in Table 10.

B. Application rate calculations. For biosolids application, a nitrogen balance must be evaluated to determine the acceptable loading rate. For frequent biosolids application, the evaluation will require an assessment of biosolids mineralization rates for organic nitrogen present in the biosolids for the year it is applied as well as residual organic nitrogen that will be mineralized from previous years' biosolids application. Table 11 summarizes acceptable organic nitrogen mineralization rates and ammonia volatilization rates for various types of biosolids and should be used in computing acceptable nitrogen loading rates unless information is provided to justify other rates. The nitrogen application rate on sites registered in the conservation reserve

plan should be established in accordance with those land use restrictions. The application rates for treated septage shall be developed using equation 1 contained in Table 12 B.

9VAC25-32-640. Maximum application rates for trace elements. (Repealed.)

The maximum cumulative application of cadmium and other biosolids borne trace elements to soils used for crop production is summarized in Table 8. Parameters other than those listed in Tables 8, 9 and 14 can be used to evaluate the application rate of biosolids in accordance with current EPA technical regulations. Exceptional quality biosolids applied to lawns or home gardens in residential areas shall be of such quality so as to conform with the pollutant levels specified in Table 7 B.

9VAC25-32-650. Maximum application rates for high lime biosolids. (Repealed.)

Application rates for alkaline stabilized biosolids may be restricted in accordance with the soil pH buffer capacity, as determined by commercial and state soil testing laboratories. The application of biosolids will affect soil pH. Unless properly controlled, high rates of calcium carbonate equivalency (i.e., CCE, which is a factor that relates the liming potential of biosolids to calcium carbonate limestone) application can have an adverse effect on crop productivity by increasing the soil pH beyond the range optimum for maximum crop production. Agricultural use of biosolids with high CCE content should be controlled to correspond with current agricultural liming practices. Calcium carbonate equivalent loadings should not exceed rates designed to attain soil pH values in the plow layer above 6.5 for soils located in the coastal plain and above 6.8 for soils located in other areas of the state.

9VAC25-32-660. Maximum application rates for biosolids. (Repealed.)

If soils exhibit very high soil test phosphorus of 55 or more parts per million phosphorus (Mehlich I analytical test procedure or equivalent procedure approved by the Department of Conservation and Recreation), the maximum application rates for phosphorus contained in biosolids together with phosphorus contained in other applied nutrient sources to the site and all applicable phosphorus management practices shall be consistent with the nutrient management plan.

TABLE 7

A. RECOMMENDED CEILING LIMITS FOR THE TRACE ELEMENT CONTENT OF BIOSOLIDS ACCEPTABLE FOR LAND APPLICATION

TRACE ELEMENT	CONCENTRATION IN MILLIGRAMS PER KILOGRAMS (DRY WEIGHT)
Arsenic	75
Cadmium	85
Copper	4300
Lead	840
Mercury	57
Molybdenum	75

Nickel	420
Selenium	100
Zinc	7500

B. MAXIMUM MONTHLY AVERAGE TRACE ELEMENT CONCENTRATIONS FOR APPLICATION OF EXCEPTIONAL QUALITY BIOSOLIDS TO LAWNS OR HOME GARDENS IN RESIDENTIAL LOCATIONS

TRACE ELEMENT	CONCENTRATION IN MILLIGRAMS PER KILOGRAMS (DRY WEIGHT)
Arsenic ⁽¹⁾	41
Cadmium	39
Copper	1500
Lead	300
Mercury	17
Molybdenum ⁽¹⁾	
Nickel	420
Selenium	100
Zinc	2800

Note: ⁽¹⁾The monthly average concentration is currently under study by USEPA.

**TABLE 8
MAXIMUM CUMULATIVE APPLICATION OF BIOSOLIDS TRACE ELEMENTS THAT CAN BE APPLIED TO SOILS USED FOR CROP PRODUCTION⁽¹⁾**

TRACE ELEMENT	Kg/ha	(lbs/AC)
Arsenic ⁽²⁾	41	(36)
Cadmium	39	(35)
Copper	1,500	(1,340)
Lead	300	(270)
Mercury	17	(16)
Molybdenum ⁽²⁾		
Nickel	420	(375)
Selenium	100	(89)
Zinc	2,800	(2,500)

Notes: ⁽¹⁾Such total applications to be made on soils with the biosolids/soil mixture pH adjusted to 6.0 or greater if the biosolids cadmium content is greater than or equal to 21 mg/kg.
 The maximum cumulative application rate is limited for all ranges of cation exchange capacity due to soil background pH in Virginia of less than 6.5 and lack of regulatory controls of soil pH adjustment after biosolids application ceases.
⁽²⁾The maximum cumulative application is currently under study by USEPA.

**TABLE 9
COMPARISONS OF TIME RESTRICTIONS FOLLOWING COMPLETION OF BIOSOLIDS APPLICATION ASSOCIATED WITH CLASS II TREATMENT LEVELS**

Regulations

Type of Application	Surface ⁽¹⁾	Incorporated ⁽²⁾
Control of Access for Public Use ⁽³⁾	12 Months	12 Months
Time lapse required before above-ground food crops with harvested parts that touch the biosolids/soil mixture can be harvested.	14 Months	14 Months
Time lapse before food crops with harvested parts below the land surface can be harvested	20 Months	38 Months
Harvesting food crops, feed crops and fiber crops	1 Month	1 Month
Grazing and feeding harvested crops to animals whose products are consumed by humans ⁽⁴⁾	1 Month	1 Month
Grazing of farm animals whose products are not consumed by humans	1 Month	1 Month
Harvesting turf for placement on land with a high potential for public exposure or a lawn ⁽⁵⁾	12 Months	12 Months

Notes: ⁽¹⁾Remains on land surface for four months or longer prior to incorporation.
⁽²⁾Remains on land surface for less than four months prior to incorporation.
⁽³⁾Public access to agricultural sites and other sites with a low potential for direct contact with the ground surface shall be controlled for 30 days.
⁽⁴⁾The restriction for lactating dairy cows is two months.
⁽⁵⁾This time restriction must be met unless otherwise specified by the permitting authority.

TABLE 10
NITROGEN REQUIREMENTS FOR AGRONOMIC RATES

A. RECOMMENDED PLANT AVAILABLE NITROGEN (PAN) APPLICATION RATES IN POUNDS OF NITROGEN (N) PER ACRE FOR VARIOUS NONIRRIGATED CROPS GROWN ON SOILS RECEIVING INFREQUENT BIOSOLIDS APPLICATIONS ⁽¹⁾									
Crop	Soil Productivity Group								
	I		II		III		IV		V
	A	B	A	B	A	B	A	B	
	lbs N/acre								
Corn grain	180	170	160	150	140	130	120	100	80
Corn silage	200	185	175	165	155	145	130	110	90
Grain sorghum	140	130	120	110	100	90	90		80
Full season Soybeans ⁽²⁾	160 to 180	150 to 170	140 to 160	130 to 150	120 to 140	110 to 130	100 to 120	85 to 105	65 to 85
Canola ⁽³⁾	100		90		80		60		60
Wheat	100		90		80		60		60
Barley	90		80		80		60		60
Rye	75		75		75		75		75

Regulations

Oats	80	80	80	60	60
Tallgrass hay ⁽⁴⁾	250	250	200	160	160
Bermudagrass hay	240–300	240–300	210–260	210–260	210–260
Pasture Fescue/Orchardgrass ⁽⁵⁾	120	120	100	80	80
Bermudagrass pasture ⁽⁷⁾	175–225	175–225	120–180	120–180	120–180
Alfalfa ⁽⁷⁾	300	300	210	150	150
Sudangrass, sudan- sorghum, millet ⁽⁶⁾	70	70	70	70	70
Stockpiled tall fescue (summer application by August 15)	60–100	60–100	50–80	50–80	50–80

Notes: ⁽¹⁾For proposed use of crops or PAN rates (lbs/A) not included in the following tables, adequate yield and PAN Data are to be submitted in accordance with Article 4 (9VAC25-32-670 et seq.) of this part.

⁽²⁾For doublecrop or late beans planted after 6/21 (of any year) allowable PAN rates are the lowest of the listed values, as rounded to nearest factor of 10.

⁽³⁾For fall application rate may sidedress up to 60 lbs fertilizer N/acre in late February before spring growth begins.

⁽⁴⁾Apply listed PAN rate when application occurs between 3/1 and 9/30 in any year and apply only one half of listed PAN rates if application will occur between 10/1 of any year and 2/28 of the following year, with remaining PAN applied after 3/1 of that following year.

⁽⁵⁾For frequent applications apply 60 lbs PAN/acre per year. Following infrequent application rate, subsequent frequent applications should be adjusted on a case-by-case basis, accounting for residual from other wastes and crops (Part IV, Table A-2).

⁽⁶⁾Sudangrass, sudan sorghum and pearl millet may receive a PAN rate of 120 lbs/A if the application occurs between 3/1 and 6/1 of any year and two cuttings are to be made, weather permitting. For Foxtail or German Millet, cut only once, application will be limited to a PAN rate of 70 LBS/A.

⁽⁷⁾From 7/1 through 9/14, applications to Bermuda grass hay or alfalfa shall only be applied at 50% of the listed rate

B. ESTIMATED YIELDS IN BUSHEL (bu) OR TONS (T) PER ACRE (A) OF VARIOUS NONIRRIGATED CROPS FOR IDENTIFIED SOIL PRODUCTIVITY GROUPS

Crop	I		II		III		IV		V
	A	B	A	B	A	B	A	B	
Corn Grain (bu/A)	180	170	160	150	140	130	120	100	80
Corn Silage (T/A)	25.4	24.4	23.4	22.5	21.5	20.5	19.5	17.5	15.6
Grain Sorghum (bu/A)	140	130	120	110	100	90	90		80
Soybeans (bu/A)									
—Early season	50	45	40		35		25		20
—Late season ⁽⁸⁾	40	34	34	30	25		18		15
Canola ⁽⁹⁾	UNDETERMINED AT THIS TIME								
Wheat (bu/A)									
—Standard	64		56		48		40		24
—Intensive	80		70		60		50		30

Regulations

Barley (bu/A)					
—Standard	110	70	60	50	30
—Intensive	115	88	75	63	38
Oats	80	80	80	60	60
Tallgrass hay (T/A)	>4.0	3.5– 4.0	3.5– 4.0	3.0–3.5	<3.0
Bermudagrass hay (T/A)	>6.0	5.0–6.0	4.0–5.0	3.0–4.0	<3.0
Alfalfa (T/A)	>6.0	4.0–6.0	<4.0	<4.0	<4.0

Notes: ⁽⁸⁾Late season beans would be planted on or after 6/21 of that year.

⁽⁹⁾Sufficient yield data not currently available.

C. RESIDUAL PLANT AVAILABLE NITROGEN (PAN) REMAINING FROM GROWTH OF VARIOUS LEGUMES DURING THE PREVIOUS YEAR⁽¹⁰⁾

Crop	%Stand	Yield Description	Residual Pan (lbs/A)
Alfalfa	50–75	Good (>4T/A)	90
	25–49	Fair (3–4T/A)	70
	<25	Poor (<3T/A)	50
Red Clover	>50	Good (>3T/A)	80
	25–49	Fair (2–3T/A)	60
	<25	Poor (<2T/A)	40
Hairy Vetch	80–100	Good	100
	50–79	Fair	75
	<50	Poor	50
Peanuts			45
Soybeans			20 ⁽¹¹⁾

Notes: ⁽¹⁰⁾The residual PAN values must be subtracted from the PAN values listed in Table A of this section to determine biosolids application rates following growth of legume crops the previous year.

⁽¹¹⁾Where yield data is available utilize 0.5 pounds per bushel.

TABLE 11
A. ESTIMATED NITROGEN MINERALIZATION RATES FOR BIOSOLIDS

Biosolids Type	Application Year ⁽¹⁾			
	0–1	1–2	2–3	3–4
Lime Stabilized	0.30	0.10	0.10	0.05
Aerobic digestion	0.30	0.10	0.10	0.05
Anaerobic digestion	0.30	0.10	0.10	0.05
Composted ⁽²⁾	0.10	0.05	0.03	0.00

Notes: ⁽¹⁾To determine nitrogen available from previous biosolids applications, multiply the initial organic nitrogen analysis by the appropriate mineralization factor.

⁽²⁾Total organic nitrogen content of 2.0% or less and no significant ammonia nitrogen.

B. ESTIMATED BIOSOLIDS AMMONIA NITROGEN AVAILABILITY FACTORS BASED ON EXPECTED VIOLATILIZATION RATES FOR BIOSOLIDS

Method of Application	Availability Factor ⁽¹⁾	
	Biosolids pH Less than 10	Biosolids pH Greater than 10
Injection below surface	1.0	1.0
Surface application with/		
–Incorporation within 24 hours	0.85	0.75
–Incorporation within 1-7 days	0.70	0.50
–Incorporation after 7 days	0.50	0.25

⁽¹⁾To determine the plant available biosolids ammonium nitrogen in the soil, multiply the biosolids ammonium nitrogen concentration or total weight applied by the appropriate availability factor.

TABLE 12

A. ORGANIC CHEMICAL TESTING THAT MAY BE REQUIRED TO IDENTIFY AN EXCEPTIONAL QUALITY BIOSOLIDS

Organic Chemicals

Aldrin/dieldrin (total)

Benzo (a) pyrene

Chlordane

DDT/DDE/DDD (total) (1)

Dimethyl nitrosamine

Heptachlor

Hexachlorobenzene

Hexachlorobutadiene

Lindane

Polychlorinated biphenols

Toxaphene

Trichloroethylene

(1)Note: DDT 2,2-Bis (chlorophenyl)-1,1,1-Trichloroethane

DDE 1,1-Bis (chlorophenyl)-2,2-Dichloroethane

DDD 1,1-Bis (chlorophenyl)-2,2-Dichloroethane

B. THE RECOMMENDED APPLICATION RATE FOR DOMESTIC SEPTAGE APPLIED TO AGRICULTURAL LAND, FOREST, OR A RECLAMATION SITE SHALL NOT EXCEED THE ANNUAL APPLICATION RATE CALCULATED USING THE FOLLOWING EQUATION:

$$AAR = N / (0.0026)$$

Where:

AAR = Annual application rate in gallons per acre per 365-day period.

N = Amount of nitrogen in pounds per acre per 305-day period needed by the crop or vegetation grown on the land.

Regulations

Article 4

Pathogen and Vector Attraction Reduction

9VAC25-32-665. Scope.

A. This article contains the requirements for a biosolids to be classified either Class A or Class B with respect to pathogens.

B. This article contains the site restrictions for land on which a Class B biosolids is applied.

C. This article contains the pathogen requirements for domestic septage applied to agricultural land, forest, or a reclamation site.

D. This article contains alternative vector attraction reduction requirements for biosolids that is applied to the land or placed on a surface disposal site.

Article 4

Permit Application Information for Biosolids Use

9VAC25-32-670. Minimum information required for a management practices plan utilizing land application. (Repealed.)

~~A. General information.~~

~~1. Legal Name and Address: The legal name of the owner making application for a permit is to appear on the title page or in the opening paragraph or both. Both the mailing and physical address should be included.~~

~~2. Owner Contact: The name, title, address, and telephone number of the individual to be contacted regarding this application should be furnished.~~

~~3. A general description of the proposed plan including name and location of generators and owners involved and copies of agreements developed, biosolids quality, biosolids treatment and handling processes, means of biosolids transport or conveyance, location and volume of storage proposed, general location of sites proposed for application and methods of biosolids application proposed. A description of temporary storage methods should be provided.~~

~~4. Written permission of landowners and farmers on a form approved by the board and pertinent lease agreements as may be necessary for operation of the treatment works.~~

~~5. Methods for notification of local government and obtaining compliance with local government zoning and applicable ordinances.~~

~~6. A copy of a letter of approval of the nutrient management plan for the operation from the Department of Conservation and Recreation if required in 9VAC25 32-680 A 3.~~

~~B. Design information.~~

~~1. Biosolids characterization.~~

~~a. Amounts and volumes to be handled.~~

~~b. Biosolids laboratory analytical data of a representative number of samples of biosolids in accordance with the~~

~~guideline specified in accordance with Tables 2 and 3. Statement that the biosolids is nonhazardous, documentation statement for treatment and quality and description of how treated biosolids meets other standards in accordance with this regulation.~~

~~2. Plans and specifications for storage facilities of all biosolids to be handled, including routine and emergency storage, shall be submitted for the issuance of a certificate to construct and a certificate to operate in accordance with the Sewage Collection and Treatment Regulations (9VAC25 790) and shall depict the following information:~~

~~a. Site layout on a recent 7.5 minute topographic quadrangle or other appropriate scaled map with the following information:~~

~~(1) Location of any required soil, geologic and hydrologic test holes or borings will be submitted.~~

~~(2) Location of the following field features within 0.25 miles of the site boundary (indicate on map) with the approximate distances from the site boundary.~~

~~(a) Water wells (operating or abandoned).~~

~~(b) Surface waters.~~

~~(c) Springs.~~

~~(d) Public water supplies.~~

~~(e) Sinkholes.~~

~~(f) Underground and/or surface mines.~~

~~(g) Mine pool (or other) surface water discharge points.~~

~~(h) Mining spoil piles and mine dumps.~~

~~(i) Quarries.~~

~~(j) Sand and gravel pits.~~

~~(k) Gas and oil wells.~~

~~(l) Diversion ditches.~~

~~(m) Occupied dwellings, including industrial and commercial establishments.~~

~~(n) Landfills dumps.~~

~~(o) Other unlined impoundments.~~

~~(p) Septic tanks and drainfields.~~

~~(q) Injection wells.~~

~~b. Topographic map (10 foot contour preferred) of sufficient detail to clearly show the following information:~~

~~(1) Maximum and minimum percent slopes.~~

~~(2) Depressions on the site that may collect water.~~

~~(3) Drainageways that may attribute to rainfall run on to or runoff from this site.~~

~~(4) Portions of the site (if any) that are located within the 100 year floodplain.~~

~~c. Data and specifications for the liner proposed for seepage control.~~

- d. Scaled plan view and cross sectional view of the facilities showing inside and outside slopes of all embankments and details of all appurtenances.
 - e. Calculations justifying impoundment capacity.
 - f. Groundwater monitoring plans for the facilities including pertinent geohydrological data to justify upgradient and downgradient well location and depth.
3. Generic plans for on site temporary storage.
4. A legible topographic map of proposed application areas to scale as needed to depict the following features:
- a. Property boundaries.
 - b. Surface water courses.
 - c. Water supply wells and springs.
 - d. Roadways.
 - e. Rock outcrops.
 - f. Slopes.
 - g. Frequently flooded areas (SCS designation).

The map shall also show the acreage to be amended with biosolids together with the net acres for biosolids application computed.

- 5. County map or other map of sufficient detail to show general location of the site and proposed transport vehicle haul routes to be utilized from the treatment plant.
- 6. A USDA soil survey map, if available, of proposed sites for land application of biosolids.
- 7. Representative soil samples are to be collected to address each major soil types for each field and analyzed for the soil parameters indicated in accordance with Table 5, and test results should be submitted with the management practices plan.
- 8. For projects utilizing frequent application of biosolids the following additional site information will be necessary.
 - a. Information specified (subdivisions 2 a and 4 of this subsection).
 - (1) Soil type.
 - (2) Soil texture for each horizon (USDA classification).
 - (3) Soil color for each horizon.
 - (4) Depth from surface to mottling and bedrock if less than two feet.
 - (5) Depth from surface to subsoil restrictive layer.
 - (6) Indicated infiltration rate (surface soil).
 - (7) Indicated permeability of subsoil restrictive layer.
 - e. Additional soil testing in accordance with Table 5.

d. Groundwater monitoring plans for the land treatment area including pertinent geohydrologic data to justify upgradient and downgradient well location and depth.

9. Description of agricultural practices including a list of proposed crops to be grown, their respective anticipated yield, planting and harvesting schedules, proposed biosolids application rates on a field by field basis and how biosolids application will be integrated with these schedules.

10. Pertinent calculations justifying storage and land area requirements for biosolids application including an annual biosolids balance incorporating such factors as precipitation, evapotranspiration, soil percolation rates, wastewater loading, monthly storage (input and drawdown).

9VAC25-32-675. Pathogens.

A. Biosolids - Class A.

1. The requirement in subdivision 2 of this subsection and the requirements in either subdivision 3, 4, 5, 6, 7, or 8 of this subsection shall be met for [a sewage sludge biosolids] to be classified as Class A biosolids with respect to pathogens.

2. The Class A pathogen requirements in subdivisions 3 through 8 of this subsection shall be met either prior to meeting or at the same time the vector attraction reduction requirements in 9VAC25-32-685, except the vector attraction reduction requirements in 9VAC25-32-685 B 6 through B 8, are met.

3. Class A - Alternative 1.

a. Either the density of fecal coliform in the biosolids shall be less than 1,000 Most Probable Number per gram of total solids (dry weight basis), or the density of Salmonella sp. bacteria in the biosolids shall be less than three Most Probable Number per four grams of total solids (dry weight basis) at the time the biosolids is used or disposed; at the time the biosolids is prepared for sale or giveaway in a bag or other container for application to the land; or at the time the biosolids or material derived from biosolids is prepared to meet the ceiling concentrations in 9VAC25-32-356 [~~Table 1~~ Table 2], the pollutant concentrations in 9VAC25-32-356 [~~Table 3~~ Table 4], the Class A pathogen requirements in subsection A of this section, and one of the vector attraction reduction requirements in 9VAC25-32-685 B 1 through B 8.

b. The temperature of the sewage sludge that is used as biosolids or disposed shall be maintained at a specific value for a period of time.

(1) When the percent solids of the sewage sludge is 7.0% or higher, the temperature of the sewage sludge shall be 50°C or higher, the time period shall be 20 minutes or longer; and the temperature and time period shall be determined using equation (1), except when small

Regulations

particles of sewage sludge are heated by either warmed gases or an immiscible liquid.

EQUATION (1)
$D = 131,700,000/10^{0.1400t}$
D = time in days
t = temperature in degrees Celsius

(2) When the percent solids of the sewage sludge is 7.0% or higher and small particles of sewage sludge are heated by either warmed gases or an immiscible liquid, the temperature of the sewage sludge shall be 50°C or higher; the time period shall be 15 seconds or longer; and the temperature and time period shall be determined using equation (1).

(3) When the percent solids of the sewage sludge is less than 7.0% and the time period is at least 15 seconds, but less than 30 minutes, the temperature and time period shall be determined using equation (1).

(4) When the percent solids of the sewage sludge is less than 7.0%, the temperature of the sewage sludge is 50°C or higher; and the time period is 30 minutes or longer; the temperature and time period shall be determined using equation (2).

EQUATION (2)
$D = 50,070,000/10^{0.1400t}$
D = time in days
t = temperature in degrees Celsius

4. Class A - Alternative 2.

a. Either the density of fecal coliform in the biosolids shall be less than 1,000 Most Probable Number per gram of total solids (dry weight basis) [~~at the time the biosolids is used or disposed;~~] or the density of Salmonella sp. bacteria in the biosolids shall be less than three Most Probable Number per four grams of total solids (dry weight basis) [at the time the biosolids is used or disposed;] at the time the biosolids is prepared for sale or giveaway in a bag or other container for application to the land; or at the time the biosolids or material derived from biosolids is prepared to meet the ceiling concentrations in 9VAC25-32-356 [~~Table 1~~ Table 2]; the pollutant concentrations in 9VAC25-32-356 [~~Table 3~~ Table 4]; the Class A pathogen requirements in subsection A of this section, and one of the vector attraction reduction requirements in 9VAC25-32-685 B 1 through B 8.

b. The pH and temperature of the sewage sludge that is used as biosolids or disposed shall be maintained at specific values for a period of time.

(1) The pH of the sewage sludge that is used as biosolids or disposed shall be raised to above 12 and shall remain above 12 for 72 hours [~~;~~]

(2) The temperature of the sewage sludge shall be above 52°C for 12 hours or longer during the period that the pH of the sewage sludge is above 12; and

(3) At the end of the 72-hour period during which the pH of the sewage sludge is above 12, the sewage sludge shall be air dried to achieve a percent solids in the sewage sludge greater than 50%.

5. Class A - Alternative 3.

a. Either the density of fecal coliform in the biosolids shall be less than 1,000 Most Probable Number per gram of total solids (dry weight basis), or the density of Salmonella sp. bacteria in biosolids shall be less than three Most Probable Number per four grams of total solids (dry weight basis) at the time the biosolids is used or disposed; at the time the biosolids is prepared for sale or giveaway in a bag or other container for application to the land; or at the time the biosolids or material derived from biosolids is prepared to meet the ceiling concentrations in 9VAC25-32-356 [~~Table 1~~ Table 2]; the pollutant concentrations in 9VAC25-32-356 [~~Table 3~~ Table 4]; the Class A pathogen requirements in subsection A of this section; and one of the vector attraction reduction requirements in 9VAC25-32-685 B 1 through B 8.

b. The sewage sludge shall be analyzed prior to pathogen treatment to determine whether the sewage sludge contains enteric viruses.

(1) When the density of enteric viruses in the sewage sludge prior to pathogen treatment is less than one [~~plaque forming unit~~ Plaque-forming Unit] per four grams of total solids (dry weight basis), the sewage sludge is Class A with respect to enteric viruses until the next monitoring episode for the sewage sludge;

(2) When the density of enteric viruses in the sewage sludge prior to pathogen treatment is equal to or greater than one [~~plaque forming unit~~ Plaque-forming Unit] per four grams of total solids (dry weight basis), the sewage sludge is Class A with respect to enteric viruses when the density of enteric viruses in the sewage sludge after pathogen treatment is less than one [~~plaque forming unit~~ Plaque-forming Unit] per four grams of total solids (dry weight basis) and when the values or ranges of values for the operating parameters for the pathogen treatment process that produces the [~~sewage sludge~~ biosolids] that meets the enteric virus density requirement are documented; and

(3) After the enteric virus reduction in subdivision 5 b (2) of this subsection is demonstrated for the pathogen treatment process, the [~~sewage sludge~~ biosolids] continues to be Class A with respect to enteric viruses

when the values for the pathogen treatment process operating parameters are consistent with the values or ranges of values documented in subdivision 5 b (2) of this subsection.

c. The sewage sludge shall be analyzed prior to pathogen treatment to determine whether the sewage sludge contains viable helminth ova.

(1) When the density of viable helminth ova in the sewage sludge prior to pathogen treatment is less than one per four grams of total solids (dry weight basis), the sewage sludge is Class A with respect to viable helminth ova until the next monitoring episode for the sewage sludge.

(2) When the density of viable helminth ova in the sewage sludge prior to pathogen treatment is equal to or greater than one per four grams of total solids (dry weight basis), the sewage sludge is Class A with respect to viable helminth ova when the density of viable helminth ova in the sewage sludge after pathogen treatment is less than one per four grams of total solids (dry weight basis) and when the values or ranges of values for the operating parameters for the pathogen treatment process that produces the sewage sludge that meets the viable helminth ova density requirement are documented.

(3) After the viable helminth ova reduction in subdivision 5 c (2) of this subsection is demonstrated for the pathogen treatment process, the sewage sludge continues to be Class A with respect to viable helminth ova when the values for the pathogen treatment process operating parameters are consistent with the values or ranges of values documented in subdivision 5 c (2) of this subsection.

6. Class A - Alternative 4.

a. Either the density of fecal coliform in the biosolids shall be less than 1,000 Most Probable Number per gram of total solids (dry weight basis), or the density of *Salmonella* sp. bacteria in the biosolids shall be less than three Most Probable Number per four grams of total solids (dry weight basis) at the time the biosolids is used or disposed; at the time the biosolids is prepared for sale or giveaway in a bag or other container for application to the land; or at the time the biosolids or material derived from biosolids is prepared to meet the ceiling concentrations in 9VAC25-32-356 [~~Table 1~~ Table 2]; the pollutant concentrations in 9VAC25-32-356 [~~Table 3~~ Table 4]; the Class A pathogen requirements in subsection A of this section; and one of the vector attraction reduction requirements in 9VAC25-32-685 B 1 through B 8.

b. The density of enteric viruses in the biosolids shall be less than one [~~plaque forming unit~~ Plaque-forming Unit] per four grams of total solids (dry weight basis) at the time the biosolids is used or disposed; at the time the

biosolids is prepared for sale or giveaway in a bag or other container for application to the land; or at the time the biosolids or material derived from biosolids is prepared to meet the ceiling concentrations in 9VAC25-32-356 [~~Table 1~~ Table 2]; the pollutant concentrations in 9VAC25-32-356 [~~Table 3~~ Table 4]; the Class A pathogen requirements in subsection A of this section; and one of the vector attraction reduction requirements in 9VAC25-32-685 B 1 through B 8, unless otherwise specified by the board.

c. The density of viable helminth ova in the sewage sludge shall be less than one per four grams of total solids (dry weight basis) at the time the biosolids is used or disposed; at the time the biosolids is prepared for sale or giveaway in a bag or other container for application to the land; or at the time the biosolids or material derived from biosolids is prepared to meet the ceiling concentrations in 9VAC25-32-356 [~~Table 1~~ Table 2]; the pollutant concentrations in 9VAC25-32-356 [~~Table 3~~ Table 4]; the Class A pathogen requirements in subsection A of this section, and one of the vector attraction reduction requirements in 9VAC25-32-685 B 1 through B 8, unless otherwise specified by the board.

7. Class A - Alternative 5.

a. Either the density of fecal coliform in the biosolids shall be less than 1,000 Most Probable Number per gram of total solids (dry weight basis), or the density of *Salmonella* sp. bacteria in the biosolids shall be less than three Most Probable Number per four grams of total solids (dry weight basis) at the time the biosolids is used or disposed; at the time the biosolids is prepared for sale or giveaway in a bag or other container for application to the land; or at the time the biosolids or material derived from biosolids is prepared to meet the ceiling concentrations in 9VAC25-32-356 [~~Table 1~~ Table 2]; the pollutant concentrations in 9VAC25-32-356 [~~Table 3~~ Table 4]; the Class A pathogen requirements in subsection A of this section; and one of the vector attraction reduction requirements in 9VAC25-32-685 B 1 through B 8.

b. Biosolids that is used or disposed shall be treated in one of the processes to further reduce pathogens described in subsection E of this section.

8. Class A - Alternative 6.

a. Either the density of fecal coliform in the biosolids shall be less than 1,000 Most Probable Number per gram of total solids (dry weight basis), or the density of *Salmonella* sp. bacteria in the biosolids shall be less than three Most Probable Number per four grams of total solids (dry weight basis) at the time the biosolids is used or disposed; at the time the biosolids is prepared for sale or giveaway in a bag or other container for application to the land; or at the time the biosolids or material derived from biosolids is prepared to meet the ceiling

Regulations

concentrations in 9VAC25-32-356 [~~Table 1~~ Table 2]; the pollutant concentrations in 9VAC25-32-356 [~~Table 3~~ Table 4]; the Class A pathogen requirements in subsection A of this section; and one of the vector attraction reduction requirements in 9VAC25-32-685 B 1 through B 8.

b. Biosolids that is used or disposed shall be treated in a process that is equivalent to a process to further reduce pathogens, as determined by the board.

B. Biosolids - Class B.

1. Minimum requirements for Class B biosolids.

a. The requirements in either subdivisions 2, 3, or 4 of this subsection shall be met for a sewage sludge to be classified as Class B biosolids with respect to pathogens.

b. The site restrictions in subdivision B 5 of this section shall be met when biosolids that meets the Class B pathogen requirements in subdivision 2, 3, or 4 of this subsection is applied to the land.

2. Class B - Alternative 1.

a. Seven representative samples of the biosolids that is used or disposed shall be collected.

b. The geometric mean of the density of fecal coliform in the samples collected in subdivision 2 a of this subsection shall be less than either 2,000,000 [~~most probable number~~ Most Probable Number] per gram of total solids (dry weight basis) or 2,000,000 [~~colony forming units~~ Colony Forming Units] per gram of total solids (dry weight basis).

3. Class B - Alternative 2. Biosolids that is used or disposed shall be treated in one of the processes to significantly reduce pathogens described in subsection D of this section.

4. Class B - Alternative 3. [~~Sewage sludge~~ Biosolids] that is used or disposed shall be treated in a process that is equivalent to a process to significantly reduce pathogens, as determined by the board.

5. Site restrictions.

a. Food crops with harvested parts that touch the biosolids/soil mixture and are totally above the land surface shall not be harvested for 14 months after application of biosolids.

b. Food crops with harvested parts below the surface of the land shall not be harvested for 20 months after application of biosolids when the biosolids remains on the land surface for four months or longer prior to incorporation into the soil.

c. Food crops with harvested parts below the surface of the land shall not be harvested for 38 months after application of biosolids when the biosolids remains on the land surface for less than four months prior to incorporation into the soil.

d. Food crops, feed crops, and fiber crops shall not be harvested for 30 days after application of biosolids.

e. Animals shall not be grazed on the land for 30 days after application of biosolids (60 days for lactating dairy livestock).

[~~f. Feeding of harvested crops to animals shall not take place for 30 days following surface application (two months for lactating dairy livestock).~~]

[~~g. f.~~] Turf grown on land where biosolids is applied shall not be harvested for one year after application of the biosolids when the harvested turf is placed on either land with a high potential for public exposure or a lawn, unless otherwise specified by the board.

[~~h. g.~~] Public access to land with a high potential for public exposure shall be restricted for one year after application of biosolids.

[~~i. h.~~] Public access to land with a low potential for public exposure shall be restricted for 30 days after application of biosolids.

Type of Application	Surface ⁽¹⁾	Incorporated ⁽²⁾
Control of access for high potential for public contact ⁽³⁾	12 months	12 months
Time lapse required before above ground food crops with harvested [plants parts] that touch the biosolids/soil mixture can be harvested	14 months	14 months
Time lapse before food crops with harvested parts below the land surface can be harvested	20 months	38 months
Harvesting food crops, feed crops and fiber crops	1 month	1 month
Grazing and feeding harvested crops to animals	1 month	1 month

whose products are consumed by humans ⁽⁴⁾		
Grazing of farm animals whose products are not consumed by humans	1 month	1 month
Harvesting turf for placement on land with a high potential for public exposure or a lawn ⁽⁵⁾	12 months	12 month
<p>Notes:</p> <p>⁽¹⁾Remains on land surface for four months or longer prior to incorporation.</p> <p>⁽²⁾Remains on land surface for less than four months prior to incorporation.</p> <p>⁽³⁾Public access to agricultural sites and other sites with a low potential for direct contact with the ground surface shall be controlled for 30 days.</p> <p>⁽⁴⁾The restriction for lactating dairy cows is [two months 60 days].</p> <p>⁽⁵⁾This time restriction must be met unless otherwise specified by the [permitting authority department].</p>		

C. Domestic septage.

[~~1.~~] The site restrictions in subdivision B 5 of this section shall be met when domestic septage is applied to agricultural land, forest, or a reclamation site [~~to~~].

[~~2. The pH of domestic septage applied to agricultural land, forest, or a reclamation site shall be raised to 12 or higher by alkaline addition and, without the addition of more alkaline material, shall remain at 12 or higher for 30 minutes and the site restrictions in subdivisions B 5 a through B 5 d of this section shall be met.]~~

D. Processes to significantly reduce pathogens (PSRP).

1. Aerobic digestion. Sewage sludge is agitated with air or oxygen to maintain aerobic conditions for a specific mean cell residence time at a specific temperature. Values for the mean cell residence time and temperature shall be between 40 days at 20°C and 60 days at 15°C.

2. Air drying. Sewage sludge is dried on sand beds or on paved or unpaved basins. The sewage sludge dries for a minimum of three months. During two of the three months, the ambient average daily temperature is above 0°C.

3. Anaerobic digestion. Sewage sludge is treated in the absence of air for a specific mean cell residence time at a specific temperature. Values for the mean cell residence

time and temperature shall be between 15 days at 35°C to 55°C and 60 days at 20°C.

4. Composting. Using either the within-vessel, static aerated pile, or windrow composting methods, the temperature of the sewage sludge is raised to 40°C or higher and remains at 40°C or higher for five days. For four hours during the five days, the temperature in the compost pile exceeds 55°C.

5. Lime stabilization. Sufficient lime is added to the sewage sludge to raise the pH of the sewage sludge to 12 after two hours of contact.

E. Processes to further reduce pathogens (PFRP).

1. Composting. Using either the within-vessel composting method or the static aerated pile composting method, the temperature of the sewage sludge is maintained at 55°C or higher for three days. Using the windrow composting method, the temperature of the sewage sludge is maintained at 55°C or higher for 15 days or longer. During the period when the compost is maintained at 55°C or higher, there shall be a minimum of five turnings of the windrow.

2. Heat drying. Sewage sludge is dried by direct or indirect contact with hot gases to reduce the moisture content of the sewage sludge to 10.0% or lower. Either the temperature of the sewage sludge particles exceeds 80°C or the wet bulb temperature of the gas in contact with the sewage sludge as the sewage sludge leaves the dryer exceeds 80°C.

3. Heat treatment. Liquid sewage sludge is heated to a temperature of 180°C or higher for 30 minutes.

4. Thermophilic aerobic digestion. Liquid sewage sludge is agitated with air or oxygen to maintain aerobic conditions and the mean cell residence time of the sewage sludge is 10 days at 55°C to 60°C.

5. Beta ray irradiation. Sewage sludge is irradiated with beta rays from an accelerator at dosages of at least 1.0 megarad at room temperature (ca. 20°C).

6. Gamma ray irradiation. Sewage sludge is irradiated with gamma rays from certain isotopes, such as Cobalt 60 and Cesium 137, at dosages of at least 1.0 megarad at room temperature (ca. 20°C).

7. Pasteurization. The temperature of the sewage sludge is maintained at 70°C or higher for 30 minutes or longer.

9VAC25-32-680. Minimum site specific information required for a management practices plan. (Repealed.)

A. Site management plans.

1. A comprehensive, general description of the operation shall be provided, including biosolids source(s), quantities, flow diagram illustrating treatment works biosolids flows and solids handling units, site description, methodology of biosolids handling for application periods, including storage and nonapplication period storage, and alternative management methods when storage is not provided.

Regulations

2. A nutrient management plan prepared by a person who is certified as a nutrient management planner by the Department of Conservation and Recreation shall be developed for all application sites prior to biosolids application. Copies of the nutrient management plan shall be provided to the farmer operator of the site, the Department of Conservation and Recreation regional office and the chief executive officer or designee for the local government, unless they request in writing not to receive the nutrient management plan.

3. A nutrient management plan approved by the Department of Conservation and Recreation shall be required for application sites prior to board authorization under specific conditions, including but not limited to, sites operated by an owner or lessee of a confined animal feeding operation, as defined in subsection A of § 62.1-44.17:1 of the Code of Virginia, or confined poultry feeding operation, as defined in subsection A of § 62.1-44.17:1.1 of the Code of Virginia; sites where land application more frequently than once every three years at greater than 50% of the annual agronomic rate is proposed, and other sites based on site specific conditions that increase the risk that land application may adversely impact state waters.

4. All nutrient management plans shall account for all sources of nutrients to be applied to the site and include at a minimum the following information: (i) a site map indicating the location of any waste storage facilities and the fields where biosolids or animal waste will be applied, (ii) site evaluation and assessment of soil types and potential productivities, (iii) nutrient management sampling including soil monitoring, (iv) biosolids or animal waste application rates based on the overall nutrient requirements of the proposed crop and soil monitoring results, and (v) biosolids and other nutrient source application schedules and land area requirements.

B. Biosolids transport.

1. Description and specifications on the bed or the tank vehicle.
2. Haul routes to be used from the biosolids generator to the storage unit and land application sites.
3. Procedures for biosolids offloading at the biosolids facilities and the land application site together with spill prevention, cleanup, (including vehicle cleaning), field reclamation and emergency spill notification and cleanup measures.
4. Voucher system used for documentation and recordkeeping.

C. Field operations.

1. Storage.
 - a. Routine storage—supernatant handling and disposal, biosolids handling, and loading of transport vehicles,

equipment cleaning, freeboard maintenance, inspections for structural integrity.

b. Emergency storage—procedures for department/board approval and implementation.

c. Temporary or field storage—procedures to be followed including either designated site locations provided in the "Design Information" or the specific site criteria for such locations including the liner/cover requirements and the time limit assigned to such use.

d. Field reclamation of offloading (staging) areas.

2. Application methodology.

a. Description and specifications on spreader vehicles.

b. Procedures for calibrating equipment for various biosolids contents to ensure uniform distribution and appropriate loading rates on a day to day basis.

c. Procedures used to ensure that operations address the following constraints: application of biosolids to frozen ground, pasture/hay fields, crops for direct human consumption and saturated or ice/snow covered ground; maintenance buffer zones, slopes, prohibited access for beef and dairy animals, soil pH requirements, and proper site specific biosolids loading rates on a field by field basis.

TABLE A-1

SLUDGE DISPOSAL SITE DEDICATION

....., a Virginia Corporation, does dedicate that tract or parcel of real estate situated, lying and being in..... County, Virginia, more particularly described by deeded and plat of survey of record in Deed Book....., pages.....,....., and....., of the Clerk's Office of the Circuit Court of..... County, Virginia, and being the identical real estate that said corporation acquired by grant with General Warranty of Title and Modern English Covenants from..... Said dedication being to establish the aforesaid area for the disposal of sewage sludge only, and that said sludge disposal site will not be used for human habitation, grazing land for domestic animals or for agricultural purposes, and will not be accessible to the public. The full interest and control of the foresaid area dedicated shall remain with the..... and this instrument is solely for the purpose of assuring the Department of Health and the Water Control Board of the Commonwealth of Virginia as to the matters hereinabove set forth. WITNESS the following signatures and seal this.... day of....., 19....

BY:..... ATTEST:.....

State of.....

County of.....

The foregoing instrument was acknowledged before me this..... day of...., 19...., by..... of..... a..... corporation, on behalf of the corporation.....

Notary Public

My Commission Expires.....

For use of Clerk of Court

This ~~Sludge Disposal Site Dedication Document~~, as described above, was recorded in Deed Book..... page... on the..... day of....., 19....

SIGNED:..... of the..... Circuit Clerks Office

9VAC25-32-685. Vector attraction reduction.

A. Conditions under which vector attraction reductions are required:

1. One of the vector attraction reduction requirements in subdivisions B 1 through B 10 of this section shall be met when bulk biosolids is applied to agricultural land, forest, a public contact site, or a reclamation site;
2. One of the vector attraction reduction requirements in subdivisions B 1 through B 8 of this section shall be met when bulk biosolids is applied to a lawn or a home garden;
3. One of the vector attraction reduction requirements in subdivisions B 1 through B 8 of this section shall be met when biosolids is sold or given away in a bag or other container for application to the land;
4. One of the vector attraction reduction requirements in subdivisions B 1 through B 11 of this section shall be met when sewage sludge (other than domestic septage) is placed on an active sewage sludge unit;
5. One of the vector attraction reduction requirements in subdivision B 9, B 10, or B 12 of this section shall be met when domestic septage is applied to agricultural land, forest, or a reclamation site; and
6. One of the vector attraction reduction requirements in subdivisions B 9 through B 12 shall be met when domestic septage is placed on an active sewage sludge unit.

B. Vector attraction reduction [~~requirements~~ options]:

1. The mass of volatile solids in the sewage sludge shall be reduced by a minimum of 38%, calculated according to the method in 9VAC25-32-450 F 8.
2. When the 38% volatile solids reduction requirement in subdivision 1 of this subsection cannot be met for an anaerobically digested sewage sludge, vector attraction reduction can be demonstrated by digesting a portion of the previously digested sewage sludge anaerobically in the laboratory in a bench-scale unit for 40 additional days at a temperature between 30°C and 37°C. When at the end of the 40 days, the volatile solids in the sewage sludge at the beginning of that period is reduced by less than 17%, vector attraction reduction is achieved.
3. When the 38% volatile solids reduction requirement in subdivision 1 of this section cannot be met for an aerobically digested sewage sludge, vector attraction reduction can be demonstrated by digesting a portion of the previously digested sewage sludge that has a percent solids

of 2.0% or less aerobically in the laboratory in a bench-scale unit for 30 additional days at 20°C. When at the end of the 30 days, the volatile solids in the sewage sludge at the beginning of that period is reduced by less than 15%, vector attraction reduction is achieved.

4. The specific oxygen uptake rate (SOUR) for sewage sludge treated in an aerobic process shall be equal to or less than 1.5 milligrams of oxygen per hour per gram of total solids (dry weight basis) at a temperature of 20°C.

5. Sewage sludge shall be treated in an aerobic process for 14 days or longer. During that time, the temperature of the sewage sludge shall be higher than 40°C and the average temperature of the sewage sludge shall be higher than 45°C.

6. The pH of sewage sludge shall be raised to 12 or higher by alkaline addition and, without the addition of more alkaline material, shall remain at 12 or higher for two hours and then at 11.5 or higher for an additional 22 hours.

7. The percent solids of sewage sludge that does not contain unstabilized solids generated in a primary wastewater treatment process shall be equal to or greater than 75% based on the moisture content and total solids prior to mixing with other materials.

8. The percent solids of sewage sludge that contains unstabilized solids generated in a primary wastewater treatment process shall be equal to or greater than 90% based on the moisture content and total solids prior to mixing with other materials.

9. [Sewage sludge injection requirements:

a. Sewage sludge shall be injected below the surface of the land.]

[~~a. b.] No significant amount of the sewage sludge shall be present on the land surface within one hour after the sewage sludge is injected.~~

[~~b. c.] When the sewage sludge that is injected below the surface of the land is Class A with respect to pathogens, the sewage sludge shall be injected below the land surface within eight hours after being discharged from the pathogen treatment process.~~

10. [Sewage sludge incorporation requirements:

a.] Sewage sludge applied to the land surface or placed on an active sewage sludge unit [~~: a. Sewage sludge~~] shall be incorporated into the soil within six hours after application to or placement on the land unless otherwise specified by the board.

b. When the sewage sludge that is incorporated into the soil is Class A with respect to pathogens, the sewage sludge shall be applied to or placed on the land within eight hours after being discharged from the pathogen treatment process.

Regulations

11. Sewage sludge placed on an active sewage sludge unit shall be covered with soil or other material at the end of each operating day.

12. The pH of domestic septage shall be raised to 12 or higher by alkaline addition and, without the addition of more alkaline material, shall remain at 12 or higher for 30 minutes.

Article 5

Certification of Land Applicators

9VAC25-32-690. Certificate requirements for land applicators.

A. No person shall land apply biosolids pursuant to a permit issued in accordance with this regulation unless an individual holding a valid certificate of competence as specified in this regulation (certified land applicator) is onsite at all times during such land application. Certified land applicators may be considered to be onsite if they are at the site permitted for land application and, if it is necessary to leave the site, they are available within 30 minutes to return to the site to verify and ensure that land application of biosolids is in compliance with the issued permit. Certified land applicators shall possess the site-specific permit information necessary to conduct land application on the site in accordance with the issued permit and make available at the land application site proper identification, including their certificate number issued by the department. [The certified land applicator shall maintain an operator field log to document at minimum, site location, arrival and departure times, inspectors or any visitors to the site, complaints received, and any unusual condition or event. The field log shall be available for inspection by the department.] Monthly reports submitted in accordance with the requirements of ~~9VAC25-32-440 B~~ 9VAC25-32-360 A shall bear the name and certificate number of the certified land applicators with an approved statement attesting that they were onsite at the times of the reported operations and that those operations were in compliance with the permit. The following parts of this regulation apply to any individual seeking a certificate of competence as required in § 62.1-44.19:3.1 of the Code of Virginia.

B. Certificates of competence shall be issued by the department to certified land applicators. The department may issue such certification based on specified areas of training, experience and level of knowledge as demonstrated through successful completion of examinations as acceptable to the department.

9VAC25-32-700. Eligibility requirements.

A. Certification may be obtained by satisfying all of the following requirements:

1. Satisfactorily completing and submitting to the department an application in the form required by the department, including a statement of any felony convictions. Such application shall be submitted to the

department at least 30 days before the scheduled examination date set by the department. The application shall request information relating to the person's education, work experience, knowledge of land application of biosolids and applicable regulations, and willingness to abide by the requirements of this regulation;

2. Supplying proof of meeting one of the following:

a. A copy of a transcript or similar documentation indicating completion of a high school or higher degree or equivalent education level with work experience in an agriculturally related area including farming and three months of practical experience related to land application of biosolids acceptable to the department;

b. A combination of training acceptable to the department that may include soil science or nutrient management or farming practice related educational training and a minimum of six months of practical experience related to land application of biosolids; or

c. Evidence of prior supervisory level experience with land application of biosolids of two or more years that is acceptable to the department;

3. Obtaining a passing score on each part of the land applicators certification examination administered by the department; and

4. Submitting the required certification fee by check or money order to the department.

B. Certificates shall be valid upon notification by the department and for two years following each renewal from the established renewal date and will expire on the last day of the expiration month. Certified land applicators or applicants shall notify the department of any change in mailing address within 30 days of such change in address.

C. The department, upon review, may accept or approve land applicator certification programs of other states as satisfying partial requirements for certification.

D. Individuals certified as land application operators in other states under certification or licensing programs acceptable to the department will be eligible for certification in Virginia by complying with all requirements of these regulations except for subdivision A 2 of this section. These individuals may also substitute, for the requirements in this regulation, 9VAC25-32-720, the attainment of a passing score on a Virginia specific examination component that shall include at a minimum the elements listed in 9VAC25-32-720 C 1 and C 6.

9VAC25-32-760. Compliance with regulations and disciplinary action.

A. If the department finds that a certified land applicator or an applicant for certification violated any applicable requirements of this regulation, including the procedural violations listed in subsection B of this section, the department may deny, suspend or revoke certification, following the informal fact-finding procedures of the

Administrative Process Act (§ 2.2-4000 et seq. of the Code of Virginia).

B. Certification procedural violations include:

1. Providing misleading, false, or fraudulent information in applying for a certificate;
2. Providing the department with any misleading, false, or fraudulent report;
3. Failing to ensure that land application of biosolids complies with permit requirements ~~in accordance with 9VAC25-32-480 through 9VAC25-32-500~~ due to negligence of responsibilities by the certified land applicator;
4. Failing to promptly and accurately record observed permit noncompliance or, failure to promptly notify the permittee of observed permit noncompliance or, preventing access to inspect any land application site or, failure to provide required field records upon request, in accordance with this regulation; and
5. Conviction of a felony related in any way to the responsibilities of a certified land applicator.

Article 6

Liability Requirements for Transport, Storage, and Land Application of Biosolids

9VAC25-32-770. Definitions.

The following terms are used in the specifications for liability insurance and the financial tests liability coverage. The definitions contained in this section are intended to assist in the understanding of these regulations and are not intended to limit the meanings of terms in a way that conflicts with general insurance industry usage or with generally accepted accounting practices.

"Assets" means all existing and all probable future economic benefits obtained or controlled by a particular entity.

"Current assets" means cash or other assets or resources commonly identified as those that are reasonably expected to be realized in cash or sold or consumed during the normal operating cycle of the business.

"Current liabilities" means obligations whose liquidation is reasonably expected to require the use of existing resources properly classifiable as current assets or the creation of other current liabilities.

"Independently audited" means an audit performed by an independent certified public accountant in accordance with generally accepted auditing standards.

"Legal defense costs" means any expenses that an insurer incurs in defending against claims of third parties brought under the terms and conditions of an insurance policy.

"Liabilities" means probable future sacrifices of economic benefits arising from present obligations to transfer assets or provide services to other entities in the future as a result of past transactions or events.

"Local government" means a county, city, or town or any authority, commission, or district created by one or more counties, cities, or towns.

"Net working capital" means current assets minus current liabilities.

"Net worth" means total assets minus total liabilities and is equivalent to owner's equity.

"Substantial business relationship" means the extent of a business relationship necessary under applicable state law to make a guarantee contract issued incident to that relationship valid and enforceable. A "substantial business relationship" must arise from a pattern of recent or ongoing business transactions, in addition to the guarantee itself, such that a currently existing business relationship between the guarantor and the permit holder is demonstrated to the satisfaction of the department.

"Tangible net worth" means the tangible assets that remain after deducting liabilities; such assets would not include intangibles such as goodwill and rights to patents or royalties.

9VAC25-32-780. Liability requirements.

A. A permit holder or applicant must demonstrate financial responsibility for clean-up costs, personal injury, bodily injury, and property damage resulting from the transport, storage, and land application of biosolids in Virginia. The permit holder or applicant must have and maintain [pollution] liability [and general liability] coverage in the amount of \$2 million per occurrence with an annual aggregate of at least \$2 million, exclusive of legal defense costs.

B. The permit holder or applicant may demonstrate the required liability coverage by using one of the mechanisms specified below:

1. [~~Having liability insurance~~ A pollution liability policy as well as a general liability policy that covers all activities associated with the "Transport, Storage, and Land Application" of biosolids] as specified in 9VAC25-32-790;

2. Passing a corporate financial test as specified in 9VAC25-32-800 or using the corporate guarantee for liability coverage as specified in 9VAC25-32-810;

3. Passing a local government financial test as specified in 9VAC25-32-820 or using the local government guarantee for liability coverage as specified in 9VAC25-32-830;

4. Obtaining a letter of credit for liability coverage as specified in 9VAC25-32-840; or

5. Obtaining a trust fund for liability coverage as specified in 9VAC25-32-850.

C. The permit holder or applicant shall notify the department in writing within 30 days whenever:

1. A claim results in a reduction in the amount of financial assurance for liability coverage provided by a financial instrument authorized in this section;

Regulations

2. A certification of valid claim for bodily injury or property damages caused by the transport, storage, or land application of biosolids in Virginia is entered between the owner or operator and a third-party claimant for liability coverage in this section; or

3. A final court order establishing a judgment for bodily injury or property damage caused by the transport, storage, or land application of biosolids in Virginia is issued against the permit holder or applicant or an instrument that is providing financial assurance for liability coverage authorized in this section.

9VAC25-32-790. Liability insurance.

A. Each [pollution and general liability] insurance policy must be amended by attachment of [~~a biosolids liability endorsement~~ an endorsement] or evidenced by a certificate of liability insurance. The wording of the endorsement must be identical to that specified in the Biosolids Liability Endorsement form. The wording of the certificate of insurance must be identical to that specified in the Certificate of Liability Insurance form. The permit holder or applicant must submit a signed duplicate original of the endorsement or the certificate of insurance to the department. If requested by the department, the permit holder or applicant must provide a signed duplicate original of the insurance policy. An applicant for a new permit must submit the signed duplicate original of the biosolids liability endorsement or the certificate of liability insurance to the department at least 60 days before the initial application of biosolids. The insurance must be effective before the initial application of biosolids.

B. Each insurance policy must be issued by an insurer that, at a minimum, is licensed to transact the business of insurance or eligible to provide insurance as an excess or surplus lines insurer in Virginia [and the insurer shall be in good financial position, as demonstrated by the AM Best (A++, A+, A, A-, B++, B+), Standard and Poor's (AAA, AA, A, BBB), or Moody's (Aaa, Aa, A, Baa) financial strength ratings].

9VAC25-32-800. Corporate financial test.

A. A permit holder or applicant may satisfy the requirements of this section by demonstrating that he passes a financial test as specified in this section. To pass this test the permit holder or applicant must meet the criteria of subsection B of this section.

B. A permit holder or applicant must have:

1. Net working capital and tangible net worth each at least six times the amount of liability coverage to be demonstrated by this test, and a tangible net worth of at least \$10 million; or

2. A current rating for his most recent bond issuance of AAA, AA, A, or BBB as issued by Standard and Poor's, or Aaa, Aa, A, or Baa as issued by Moody's and a tangible net worth of at least \$10 million; and a tangible net worth at least six times the amount of liability coverage to be

demonstrated by this test; and assets in the United States amounting to either:

a. At least 90% of this total assets; or

b. At least six times the amount of liability coverage to be demonstrated by this test.

3. For the purposes of this section, the phrase "amount of liability coverage" refers to the annual aggregate amounts for which coverage is required under 9VAC25-32-780 A.

C. To demonstrate that he passes this test, the permit holder or applicant must submit the following three items to the department:

1. A letter signed by the permit holder or applicant's chief financial officer;

2. A copy of the independent certified public accountant's report on examination of the permit holder or applicant's financial statements for the latest completed fiscal year; and

3. A special report from the permit holder or applicant's independent certified public accountant to the permit holder or applicant stating that:

a. He has compared the data that the letter from the chief financial officer specifies as having been derived from the independently audited, year-end financial statements for the latest fiscal year with the amounts in such financial statements; and

b. In connection with that procedure, no matters came to his attention that caused him to believe that the specified data should be adjusted.

D. A new permit holder or new applicant must submit the items specified in subsection C of this section at least 30 days before the date on which the biosolids are first applied.

E. After the initial submission of the items specified in subsection C of this section, the permit holder or applicant must send updated information to the department within 90 days after the close of each succeeding fiscal year. This information must consist of all three items specified in subsection C of this section.

F. If the permit holder or applicant no longer meets the requirements of subsection B of this section, he must obtain insurance, a letter of credit, a surety bond, a trust fund, or a guarantee for the entire amount of the required liability coverage as specified in this section. Evidence of liability coverage must be submitted to the department within 90 days after the end of the fiscal year for which the year-end financial data show that the permit holder or applicant no longer meets the test requirements.

G. The department may disallow use of this test on the basis of qualifications in the opinion expressed by the independent certified public accountant in his report on an examination of the permit holder's or applicant's financial statements. An adverse opinion or a disclaimer of opinion may be cause for disallowance. The department will evaluate other

qualifications on an individual basis. The permit holder or applicant must provide evidence for the entire amount of the required liability coverage as specified in this section within 30 days of notification of disallowance.

9VAC25-32-810. Corporate guarantee.

A. A permit holder or applicant may meet the requirements of this section by obtaining a written guarantee, hereafter referred to as "guarantee." The guarantor must be the direct or higher-tier parent corporation of the permit holder or applicant; a firm whose parent corporation is also the parent corporation of the permit holder or applicant; or a firm with a substantial business relationship with the permit holder or applicant. The guarantor must meet the requirements for the permit holder or applicant as specified in 9VAC25-32-800. A certified copy of the guarantee must accompany the items sent to the department as specified in 9VAC25-32-800 C. One of these items must be the letter from the guarantor's chief financial officer. If the guarantor's parent corporation is also the parent corporation of the permit holder or the applicant, this letter must describe the value received in consideration of the guarantee. If the guarantor is a firm with a substantial business relationship with the permit holder or applicant, this letter must describe this substantial business relationship and the value received in consideration of the guarantee.

B. If the permit holder or applicant fails to satisfy a judgment based on a determination of liability for bodily injury or property damage to third parties caused by the transport, storage, or land application of biosolids in Virginia or fails to pay an amount agreed to in a settlement of claims arising from or alleged to arise from such injury or damage, the guarantor will do so up to the limits of coverage.

C. The guarantee will remain in force unless the guarantor sends notice of cancellation by certified mail to the permit holder or applicant and to the department. Cancellation may not occur, however, during the 120 days beginning on the date of receipt of the notice of cancellation by both the permit holder or applicant and the department, as evidenced by return receipts.

D. If a guarantee is cancelled, the permit holder or applicant shall, within 90 days following receipt of the cancellation notice by the permit holder or applicant and the department, obtain alternate financial assurance and provide evidence of that alternate financial assurance to the department. If the permit holder or applicant fails to provide evidence of alternate financial assurance within the 90-day period, the guarantor shall provide that alternate financial assurance within 120 days following the close of the guarantor's fiscal year; obtain alternate assurance acceptable to the department; and provide evidence of the alternate assurance to the department.

E. Recordkeeping and reporting.

1. The permit holder or applicant shall submit a signed original guarantee to the department along with the items

required under 9VAC25-32-800 C. The guarantee shall be worded as specified on the Corporate Guarantee form.

2. The permit holder or applicant is no longer required to maintain the items specified in 9VAC25-32-800 C when:

- a. The permit holder or applicant substitutes alternate financial assurance as specified in this section; or
- b. The permit holder or applicant is released from the requirements of this chapter.

F. If a guarantor no longer meets the requirements specified in this section, the permit holder or applicant shall, within 90 days following close of the guarantor's fiscal year, obtain alternate financial assurance acceptable to the department and submit evidence of the alternate financial assurance to the department. If the permit holder or applicant fails to provide alternate financial assurance within the 90-day period, the guarantor shall provide that alternate financial assurance within 120 days.

9VAC25-32-820. Local government financial test.

A. A permit holder or applicant that satisfies the requirements of this section may demonstrate financial assurance using the local government financial test.

B. The permit holder or applicant shall satisfy the provisions of this section as applicable:

1. If the permit holder or applicant has outstanding, rated general obligation bonds that are not secured by insurance, a letter of credit, or other collateral or guarantee, he shall supply the department with documentation demonstrating that the permit holder or applicant has a current rating of Aaa, Aa, A, or Baa as issued by Moody's or AAA, AA, A, or BBB as issued by Standard and Poor's on all such general obligation bonds; or

2. If the permit holder or applicant does not have outstanding, rated general obligation bonds, he shall satisfy each of the following financial ratios based on the permit holder's or applicant's most recent audited annual financial statements:

- a. A ratio of cash plus marketable securities to total expenditures greater than or equal to 0.05; and
- b. A ratio of annual debt service to total expenditures less than or equal to 0.20.

C. The permit holder or applicant shall prepare his financial statements in conformity with generally accepted accounting principles for governments and have his financial statements audited by an independent certified public accountant or by the Auditor of Public Accounts.

D. A permit holder or applicant is not eligible to assure its obligations under this section if he:

- 1. Is currently in default on any outstanding general obligation bonds;
- 2. Has any outstanding general obligation bonds rated lower than Baa as issued by Moody's or BBB as issued by Standard and Poor's;

Regulations

3. Operated at a deficit equal to 5.0% or more of total annual revenue in each of the past two fiscal years; or

4. Receives an adverse opinion, disclaimer of opinion, or other qualified opinion from the independent certified public accountant or Auditor of Public Accounts auditing his financial statements as required under subsection C of this section. However, the department may evaluate qualified opinions on a case-by-case basis and allow use of the financial test in cases where the department deems the qualification insufficient to warrant disallowance of the test.

E. The local government permit holder or applicant must submit to the department the following items:

1. An original letter signed by the local government's chief financial officer stating that the permit holder or applicant meets the requirements of this section;

2. The local government's independently audited year-end financial statements for the latest fiscal year, including the unqualified opinion of the auditor who must be an independent, certified public accountant or an appropriate state agency that conducts equivalent comprehensive audits;

3. A report of the local government from the local government's independent certified public accountant or the Auditor of Public Accounts based on performing an agreed upon procedures engagement relative to the financial ratios required by subdivision B 2 of this section, if applicable, and the requirements of this section. The certified public accountant's or state agency's report shall state the procedures performed and the certified public accountant's or state agency's findings; and

4. A copy of the comprehensive annual financial report (CAFR) used to comply with subdivision B 2 of this section.

9VAC25-32-830. Local government guarantee.

A. A local government who is also the permit holder or applicant may meet the requirements of this section by providing a written guarantee, herein referred to as "guarantee" by a local government. The guarantor shall meet the requirements of the local government financial test in section 9VAC25-32-820 and shall comply with the terms of the written guarantee identified in subsection B of this section.

B. Terms of the written guarantee.

1. The guarantee shall be effective before the initial application of biosolids [;] and

2. The guarantee shall provide that:

a. If the permit holder or applicant fails to satisfy a judgment based on a determination of liability for bodily injury or property damage to third parties caused by the transport, storage, or land application of biosolids in Virginia or fails to pay an amount agreed to in settlement

of claims arising from or alleged to arise from such injury or damage, the guarantor will do so up to the limits of coverage;

b. The guarantee will remain in force unless the guarantor sends notice of cancellation by certified mail to the permit holder or applicant and to the department. Cancellation may not occur, however, during the 120 days beginning on the date of receipt of the notice of cancellation by both the permit holder or applicant and the department, as evidenced by return receipts; and

c. If a guarantee is cancelled, the permit holder or applicant shall within 90 days following receipt of the cancellation notice by the permit holder or the applicant and the department obtain alternate financial assurance and notify the department. If the permit holder or applicant fails to provide alternate financial assurance within the 90-day period, the guarantor shall provide that alternate financial assurance within 120 days following the close of the guarantor's fiscal year; obtain alternative financial assurance acceptable to the department; and submit evidence of that alternate financial assurance to the department.

C. Recordkeeping and reporting.

1. The permit holder or applicant shall submit a signed original guarantee on the Local Government Guarantee form to the department along with the items required under 9VAC25-32-820 E before the initial application of biosolids.

2. The permit holder or applicant is no longer required to maintain the items specified in 9VAC25-32-820 E when:

a. The permit holder or applicant substitutes alternate financial assurance as specified in this section; or

b. The permit holder or applicant is released from the requirements of this section.

D. If a local government guarantor no longer meets the requirements of this section, the permit holder or applicant shall, within 90 days following the close of the guarantor's fiscal year, obtain alternate financial assurance acceptable to the department and submit evidence of that alternate financial assurance to the department. If the permit holder or applicant fails to provide alternate financial assurance within the 90-day period, the guarantor shall provide that alternate financial assurance within 120 days.

9VAC25-32-840. Letter of credit.

A. A permit holder or applicant may satisfy the requirements of this article by obtaining an irrevocable standby letter of credit that satisfies the terms of the letter of credit and by submitting the original letter of credit to the department.

B. Terms of the letter of credit.

1. The letter of credit shall be effective before the initial application of biosolids.

2. The issuing institution shall be a bank or other financial institution that has the authority to issue letters of credit and whose letter of credit operations are regulated and examined by the Commonwealth of Virginia, by a federal agency, or by an agency of another state.

3. The letter of credit shall be irrevocable and issued for a period of at least one year in an amount of \$2 million to cover the costs for clean-up costs, personal injury, bodily injury, and property damage that may result from the transport, storage, or land application of biosolids in Virginia by the permit holder or applicant.

4. The letter of credit shall provide that the expiration date will be automatically extended for a period of at least one year. If the issuing institution decides not to extend the letter of credit beyond the current expiration date, it shall, at least 120 days before the date, notify both the permit holder or applicant and the department by certified mail of that decision. The 120-day period will begin on the date of receipt by the department as shown on the signed return receipt. Expiration cannot occur, however, while an enforcement action is pending. Within 60 days of receipt of notice from the issuing institution that it does not intend to extend the letter of credit, the permit holder or applicant shall obtain alternate financial assurance and submit evidence of the alternate financial assurance to the department.

C. In the event of failure of the permit holder or applicant to comply with the requirements of this article, the department may cash the letter of credit.

D. The permit holder or applicant may cancel the letter of credit only if alternate financial assurance acceptable to the department is substituted as specified in this article or if the permit holder or applicant is released by the department from the requirements of this chapter.

E. The department shall return the original letter of credit to the issuing institution for termination when:

1. The permit holder or applicant substitutes acceptable alternate financial assurance for clean-up costs, personal injury, bodily injury, and property damage resulting from the transport, storage, or land application of biosolids in Virginia; or

2. The department notifies the permit holder or applicant that he is no longer required by this article to maintain financial assurance for clean-up costs, personal injury, bodily injury, and property damage resulting from the transport, storage, or land application of biosolids in Virginia.

F. The permit holder or applicant shall establish a standby trust fund. The standby trust fund shall meet the requirements of 9VAC25-32-850, except the requirements for initial payments and subsequent annual payments.

G. Payments made under the terms of the letter of credit will be deposited by the issuing institution directly into the

standby trust fund. Payments from the trust fund shall be approved by the department.

H. The department may cash the letter of credit if it is not replaced 30 days prior to expiration with alternate financial assurance approved by the department.

I. The wording of the letter of credit shall be identical to that specified in the Letter of Credit form.

9VAC25-32-850. Trust fund.

A. A permit holder or applicant may satisfy the requirements of this article by establishing a trust fund that conforms to the requirements of subsection B of this section and submitting an originally signed duplicate of the trust agreement to the department.

B. Trust fund requirements.

1. The trustee must be an entity that has the authority to act as a trustee and whose trust operations are regulated and examined by the Commonwealth of Virginia, by a federal agency, or by an agency of another state.

2. The trust fund for liability coverage must be funded for the full amount of the liability coverage to be provided by the trust fund before it may be relied upon to satisfy the requirements of this section. If at any time after the trust fund is created, the amount of funds in the trust fund is reduced below the full amount of the liability coverage to be provided, the permit holder or applicant, by the anniversary date of the establishment of the fund, must either add sufficient funds to the trust fund to cause its value to be equal to the full amount of the liability coverage to be provided, or obtain other alternate financial assurance as specified in this section to cover the difference.

3. For purpose of this section, "the full amount of liability coverage provided" means the amount of coverage for clean-up costs, personal injury, bodily injury, and personal damage resulting from the transport, storage, or land application of biosolids in Virginia.

4. The wording of the trust fund must be identical to that specified in the Trust Fund form.

NOTICE: The following forms used in administering the regulation were filed by the agency. The forms are not being published; however, online users of this issue of the Virginia Register of Regulations may click on the name to access a form. The forms are also available from the agency contact or may be viewed at the Office of the Registrar of Regulations, General Assembly Building, 2nd Floor, Richmond, Virginia 23219.

FORMS (9VAC25-32)

[Virginia Pollution Abatement Permit Application, General Instructions \(rev. 4/09\).](#)

[Virginia Pollution Abatement Permit Application, Form A, All Applicants \(rev. 4/09\).](#)

Regulations

[Virginia Pollution Abatement Permit Application, Form B, Animal Waste \(rev. 10/95\).](#)

[Virginia Pollution Abatement Permit Application, Form C, Industrial Waste \(rev. 10/95\).](#)

[~~[Virginia Pollution Abatement Permit Application, Form D, Municipal Effluent and Biosolids \(rev. 9/12\).](#)~~

[Virginia Pollution Abatement Permit Application, Form D, Municipal Effluent and Biosolids Cover Page \(rev. 6/13\):](#)

[Part D-I: Land Application of Municipal Effluent \(rev. 4/09\).](#)

[Part D-II: Land Application of Biosolids \(rev. 6/13\).](#)

[Part D-III: Effluent Characterization Form \(rev.4/09\).](#)

[Part D-IV: Biosolids Characterization Form \(rev. 6/13\).](#)

[Part D-V: Non-Hazardous Waste Declaration \(rev. 6/13\).](#)

[Part D-VI: Land Application Agreement - Biosolids and Industrial Residuals \(rev. 9/12\).](#)

[Part D-VII: Request for Extended Setback from Biosolids Land Application Field \(rev. 10/11\). \]](#)

[Application for Land Application Supervisor Certification \(rev. 2/11\).](#)

[Application for Renewal of Land Application Supervisor Certification \(rev. 2/11\).](#)

[Sludge Disposal Site Dedication Form, Form A-1 \(rev. 11/09\).](#)

[~~[Biosolids Land Application Local Monitoring Expenses Reimbursement Invoice, Form I \(rev. 5/10\).](#)~~]

[Liability Requirements for Transport, Storage, and Land Application of Biosolids, Form I, Insurance Liability Endorsement \(rev. 11/09\).](#)

[Liability Requirements for Transport, Storage, and Land Application of Biosolids, Form II, Certificate of Liability Insurance \(rev. 11/09\).](#)

[Liability Requirements for Transport, Storage, and Land Application of Biosolids, Form III, Corporate Letter \(rev. 11/09\).](#)

[Liability Requirements for Transport, Storage, and Land Application of Biosolids, Form IV, Corporate Guarantee \(rev. 11/09\).](#)

[Liability Requirements for Transport, Storage, and Land Application of Biosolids, Form V, Letter of Credit \(rev. 11/09\).](#)

[Liability Requirements for Transport, Storage, and Land Application of Biosolids, Form VI, Trust Agreement \(rev. 11/09\).](#)

DOCUMENTS INCORPORATED BY REFERENCE (9VAC25-32)

Environmental Regulations and Technology-Control of Pathogens and Vector Attraction in Sewage Sludge, EPA-625/R-92/013, July 2003, U.S. Environmental Protection Agency, Cincinnati, Ohio 45268.

[[Method 1668B Chlorinated Biphenyl Congeners in Water, Soil, Sediment, Biosolids, and Tissue by HRGC/HRMS, EPA-821-R-08-020, November 2008, U.S. Environmental Protection Agency, Officer of Water and Office of Science and Technology Engineering and Analysis Division \(4303T\), 1200 Pennsylvania Avenue, NW, Washington, DC 20460. \]](#)

[Glossary-Water and Wastewater Control Engineering, 1969, American Public Health Association \(APHA\), American Society of Civil Engineers \(ASCE\), American Water Works Association \(AWWA\), and the Water Environment Federation \(WEF\).](#)

[Test Methods for Evaluating Solid Waste, Physical/Chemical Methods, EPA Publication SW-846, Third Edition \(1986\) as amended by final updates I, II, IIA, IIB, IIIA, IIIB, IVA, and IVB, National Technical Information Service, Springfield, Virginia.](#)

VA.R. Doc. No. R08-1248; Filed June 26, 2013, 3:55 p.m.

◆ ————— ◆

TITLE 10. FINANCE AND FINANCIAL INSTITUTIONS

STATE CORPORATION COMMISSION

Proposed Regulation

REGISTRAR'S NOTICE: The State Corporation Commission is claiming an exemption from the Administrative Process Act in accordance with § 2.2-4002 A 2 of the Code of Virginia, which exempts courts, any agency of the Supreme Court, and any agency that by the Constitution is expressly granted any of the powers of a court of record.

Title of Regulation: **10VAC5-161. Mortgage Loan Originators (amending 10VAC5-161-10, 10VAC5-161-20, 10VAC5-161-60; adding 10VAC5-161-75, 10VAC5-161-90).**

Statutory Authority: §§ 6.2-1720 and 12.1-13 of the Code of Virginia.

Public Hearing Information: A public hearing will be held upon request.

Public Comment Deadline: August 16, 2013.

Agency Contact: E.J. Face, Jr., Commissioner of Financial Institutions, State Corporation Commission, P.O. Box 640, Richmond, VA 23218, telephone (804) 371-9659, FAX (804) 371-9416, or email joe.face@scc.virginia.gov.

Summary:

The proposed regulations (i) set forth the procedures and criteria for designating bona fide nonprofit organizations under § 6.2-1701.1 of the Code of Virginia; (ii) define the terms "employee" and "exclusive agent"; (iii) clarify the licensing requirements for individuals whose wages or

other compensation is paid by either professional employer organizations or organizations that provide staffing services; (iv) require a licensed mortgage loan originator (licensee) to ensure that all residential mortgage loans that close as a result of the licensee engaging in the business of a mortgage loan originator are included in reports of condition submitted to the Nationwide Mortgage Licensing System and Registry; and (v) require the Commissioner of Financial Institutions to establish a process whereby mortgage loan originators may challenge information entered into the registry by the bureau.

AT RICHMOND, JULY 3, 2013

COMMONWEALTH OF VIRGINIA, ex rel.

STATE CORPORATION COMMISSION

CASE NO. BFI-2013-00067

Ex Parte: In re: Mortgage Loan Originators

ORDER TO TAKE NOTICE

Section 6.2-1720 of the Code of Virginia provides that the State Corporation Commission ("Commission") shall adopt such regulations as it deems appropriate to effect the purposes of Chapter 17 (§ 6.2-1700 et seq.) of Title 6.2 of the Code of Virginia. The Commission's regulations governing mortgage loan originators are set forth in Chapter 161 of Title 10 of the Virginia Administrative Code ("Chapter 161").

The Bureau of Financial Institutions ("Bureau") has submitted to the Commission proposed amendments to Chapter 161. The proposed regulations (i) set forth the procedures and criteria for designating bona fide nonprofit organizations under § 6.2-1701.1 of the Code of Virginia; (ii) define the terms "employee" and "exclusive agent"; (iii) clarify the licensing requirements for individuals whose wages or other compensation is paid by either professional employer organizations or organizations that provide staffing services; (iv) require a licensed mortgage loan originator ("licensee") to ensure that all residential mortgage loans that close as a result of the licensee engaging in the business of a mortgage loan originator are included in reports of condition submitted to the Nationwide Mortgage Licensing System and Registry ("Registry"); and (v) require the Commissioner of Financial Institutions to establish a process whereby mortgage loan originators may challenge information entered into the Registry by the Bureau.

NOW THE COMMISSION, based on the information supplied by the Bureau, is of the opinion and finds that the proposed regulations should be considered for adoption with a proposed effective date of September 15, 2013.

Accordingly, IT IS ORDERED THAT:

(1) The proposed regulations are appended hereto and made a part of the record herein.

(2) Comments or requests for a hearing on the proposed regulations must be submitted in writing to Joel H. Peck, Clerk, State Corporation Commission, c/o Document Control

Center, P.O. Box 2118, Richmond, Virginia 23218, on or before August 16, 2013. Requests for a hearing shall state why a hearing is necessary and why the issues cannot be adequately addressed in written comments. All correspondence shall contain a reference to Case No. BFI-2013-00067. Interested persons desiring to submit comments or request a hearing electronically may do so by following the instructions available at the Commission's website: <http://www.scc.virginia.gov/case>.

(3) This Order and the attached proposed regulations shall be posted on the Commission's website at <http://www.scc.virginia.gov/case>.

(4) The Commission's Division of Information Resources shall send a copy of this Order, including a copy of the attached proposed regulations, to the Virginia Registrar of Regulations for publication in the Virginia Register of Regulations.

AN ATTESTED COPY hereof, together with a copy of the proposed regulations, shall be sent by the Clerk of the Commission to the Commission's Office of General Counsel and the Commissioner of Financial Institutions, who shall forthwith send by e-mail or U.S. mail a copy of this Order, together with a copy of the proposed regulations, to all licensed mortgage loan originators, licensed mortgage lenders, licensed mortgage brokers, and such other interested parties as he may designate.

10VAC5-161-10. Definitions.

A. The following words and terms when used in this chapter shall have the following meanings unless the context clearly indicates otherwise:

"Bureau," "commission," "commissioner," and "person" shall have the meanings ascribed to them in § 6.2-100 of the Code of Virginia.

"Chapter 16" means Chapter 16 (§ 6.2-1600 et seq.) of Title 6.2 of the Code of Virginia.

"Chapter 17" means Chapter 17 (§ 6.2-1700 et seq.) of Title 6.2 of the Code of Virginia.

~~"License application" means a written request for a mortgage loan originator license pursuant to Chapter 17 and this chapter.~~

"Licensee" Employee. "licensee." "mortgage loan originator," "registered mortgage loan originator," "registry," "residential mortgage loan," and "unique identifier" shall have the meanings ascribed to them in § 6.2-1700 of the Code of Virginia.

"Exclusive agent" for purposes of Chapter 17 and this chapter means an individual who engages in the business of a mortgage loan originator solely on behalf of a particular mortgage broker or mortgage lender, and not on his own behalf or on behalf of any other person. The term does not include an employee of a mortgage broker or a mortgage lender.

Regulations

"License application" means a written request for a mortgage loan originator license pursuant to Chapter 17 and this chapter.

B. Any term or phrase not defined in Chapter 17 or this chapter shall be construed in accordance with 12 CFR Parts 1007 and 1008.

10VAC5-161-20. Individuals subject to licensure.

A. Unless exempt from licensure pursuant to subsection B of § 6.2-1701 of the Code of Virginia, the following individuals who engage in the business of ~~taking applications for residential mortgage loans, or offering or negotiating the terms of residential mortgage loans, a mortgage loan originator~~ shall obtain and maintain annually a license pursuant to Chapter 17 and this chapter:

1. Individuals who are employees or exclusive agents of a person licensed under Chapter 16. ~~This includes individuals who are employees of~~ Individuals whose wages or other compensation is paid by either professional employment employer organizations or organizations that provide staffing services, ~~who shall become and remain exclusive agents of a person licensed under Chapter 16. In the case of individuals who are exclusive agents of a person licensed under Chapter 16, the individuals and person licensed under Chapter 16 shall comply with such conditions as the commissioner may prescribe pursuant to subsection A of § 6.2-1601 of the Code of Virginia.~~

2. Individuals, other than registered mortgage loan originators, who are employees or exclusive agents of a person exempt from licensure under Chapter 16.

3. Individuals who are not employees or exclusive agents of either a person licensed under Chapter 16 or a person exempt from such licensure.

B. For purposes of Chapter 17 and this chapter:

1. An individual takes an application for a residential mortgage loan if the individual receives a residential mortgage loan application for the purpose of facilitating a decision whether to extend an offer of residential mortgage loan terms to a borrower or prospective borrower, or to accept the terms offered by a borrower or prospective borrower in response to a solicitation.

2. An individual offers or negotiates the terms of a residential mortgage loan if the individual:

- a. Presents for consideration by a borrower or prospective borrower particular residential mortgage loan terms;
- b. Communicates directly or indirectly with a borrower or prospective borrower for the purpose of reaching a mutual understanding about prospective residential mortgage loan terms; or
- c. Recommends, refers, or steers a borrower or prospective borrower to a particular lender or set of residential mortgage loan terms, in accordance with a

duty to or incentive from any person other than the borrower or prospective borrower.

10VAC5-161-60. Required reports and notices; information in registry.

A. Each person for whom an individual described in 10VAC5-161-20 A 1 or 2 engages in the business of a mortgage loan originator shall file, on or before March 1 of each year, an annual report with the bureau stating the amount of residential mortgage loans made or brokered during the preceding calendar year, identifying all licensees performing services for that person, and providing such additional information as the bureau may require. Timely filing of the annual report required by Chapter 16 by a person licensed under that chapter shall constitute compliance with this subsection by that person if the annual report contains the information specified in this subsection.

B. Each licensee who is an individual described in 10VAC5-161-20 A 3 shall file, on or before March 1 of each year, an annual report with the bureau stating the amount of residential mortgage loans originated during the preceding calendar year and providing such additional information as the bureau may require.

C. Each licensee shall give notice to the bureau through the registry within five days after the occurrence of either of the following events:

1. Termination of, or separation from, employment or exclusive agency as a mortgage loan originator for a person licensed or exempt from licensing under Chapter 16. A licensee who is no longer an employee or exclusive agent of a person licensed or exempt from licensing under Chapter 16 shall not engage in activities requiring licensure under Chapter 16 until such time as (i) the individual obtains a mortgage broker license under Chapter 16 or (ii) the individual becomes a bona fide employee or exclusive agent of a person who is licensed or exempt from licensing under Chapter 16 and the requirements set forth in (i) and (ii) of subdivision 2 of this subsection have been satisfied.

2. Commencement of employment or exclusive agency as a mortgage loan originator for a person licensed or exempt from licensing under Chapter 16. A licensee who becomes an employee or exclusive agent of a person licensed or exempt from licensing under Chapter 16 shall not engage in activities requiring licensure under Chapter 16 until (i) the person licensed or exempt from licensing under Chapter 16 has complied with the surety bond filing requirements of § 6.2-1703 of the Code of Virginia, 10VAC5-161-30 B, and 10VAC5-161-50 and (ii) the bureau has received a sponsorship request through the registry.

D. Pursuant to subsection B of § 6.2-1711 of the Code of Virginia, each licensee shall notify the commissioner through the registry within 10 days of any change of residential or business address. A licensee described in 10VAC5-161-20 A 1 or 2 shall be deemed to have complied with this

requirement if a person licensed or exempt from licensing under Chapter 16 timely submits such notice on behalf of its employee or exclusive agent.

E. Each licensee shall ensure that all residential mortgage loans that close as a result of the licensee engaging in the business of a mortgage loan originator are included in reports of condition submitted to the registry. Reports of condition shall be in such form, contain such information, and be submitted with such frequency and by such dates as the registry may require.

F. The commissioner shall establish a process whereby mortgage loan originators may challenge information entered into the registry by the bureau.

10VAC5-161-75. Bona fide nonprofit organizations.

A. An organization may request that the commission designate it as a bona fide nonprofit organization for purposes of Chapter 17 and this chapter by (i) submitting its request on a form prescribed by the commissioner, (ii) paying a nonrefundable fee of \$200, and (iii) furnishing such information concerning the criteria in subsection B of this section as the commissioner may require. If the registry is capable of processing these requests, the organization shall submit its request through the registry and shall pay or cause to be paid any fees imposed by the registry in addition to the fee payable to the commission.

B. The commission shall designate an organization as a bona fide nonprofit organization only if (i) the organization has satisfied the requirements of subsection A of this section and (ii) the commission finds that the organization:

1. Has the status of a tax-exempt organization under § 501(c)(3) of the Internal Revenue Code of 1986.
2. Promotes affordable housing or provides homeownership education or similar services.
3. Conducts its activities in a manner that serves public or charitable purposes rather than commercial purposes.
4. Charges fees and receives funding and revenue in a manner that does not incentivize it or its employees to act other than in the best interests of its clients.
5. Compensates its employees in a manner that does not incentivize employees to act other than in the best interests of its clients.
6. Provides or identifies for a borrower residential mortgage loans with terms that are (i) favorable to the borrower and (ii) comparable to mortgage loans and housing assistance provided under government housing assistance programs. For purposes of this subdivision and subdivision B 10 of § 6.2-1701 of the Code of Virginia, loan terms shall be considered favorable to the borrower if the terms are consistent with loan origination in a public or charitable context rather than a commercial context.
7. Meets any other criteria that the commission deems relevant.

C. If the commission is unable to make all of the findings required by subsection B of this section, the commission shall notify the organization in writing and provide the basis for its determination.

D. A bona fide nonprofit organization shall give written notice to the bureau within five days of the following: (i) any change in, or revocation of, the organization's tax-exempt status under § 501(c)(3) of the Internal Revenue Code of 1986 or (ii) any change in the organization's mission, policies, or practices that is inconsistent with any of the criteria enumerated in subsection B of this section.

E. When the bureau requests a written response, books, records, documentation, or other information from a bona fide nonprofit organization, the organization shall deliver a written response as well as any requested books, records, documentation, or information within the time period specified in the bureau's request or, if no time period is specified, not later than 30 days from the date of such request. In determining the specified time period for responding to the bureau and when considering a request for an extension of time to respond, the bureau shall take into consideration the volume and complexity of the requested written response, books, records, documentation or information and such other factors as the bureau determines to be relevant under the circumstances. Requests made by the bureau pursuant to this subsection are deemed to be in furtherance of the investigation and examination authority provided for in § 6.2-1701.1 of the Code of Virginia.

10VAC5-161-90. Commission authority.

The commission may, at its discretion, waive or grant exceptions to any provision of this chapter for good cause shown.

VA.R. Doc. No. R13-3754; Filed July 8, 2013, 11:12 a.m.



TITLE 12. HEALTH

STATE BOARD OF HEALTH

Final Regulation

REGISTRAR'S NOTICE: The purpose of this notice is to officially remove the repealed State Board of Health Biosolids Use Regulations (12VAC5-585) from the Virginia Administrative Code. These regulations have been superseded by State Water Control Board action and subsequently repealed by the State Water Control Board. (NOTE: this announcement does not impact final amendments to certain State Water Control Board regulations concerning the biosolids program that are published in this issue of the Virginia Register. This announcement only serves to remove superseded State Board of Health regulations on biosolids.)

The State Water Control Board is claiming an exemption from the Administrative Process Act in accordance with

Regulations

§ 2.2-4006 A 4 a of the Code of Virginia, which excludes regulations that are necessary to conform to changes in Virginia statutory law where no agency discretion is involved. The State Water Control Board will receive, consider, and respond to petitions from any interested person at any time with respect to reconsideration or revision.

Title of Regulation: **12VAC5-585. Biosolids Use Regulations (repealing 12VAC5-585-10 through 12VAC5-585-830).**

Statutory Authority: § 62.1-44.15 of the Code of Virginia.

Effective Date: September 1, 2013.

Agency Contact: Cindy M. Berndt, Director, Regulatory Affairs, Department of Environmental Quality, 629 East Main Street, P.O. Box 1105, Richmond, VA 23218, telephone (804) 698-4378, FAX (804) 698-4346, or email cindy.berndt@deq.virginia.gov.

Background: Chapters 881 and 929 of the 2007 Acts of Assembly transferred the regulation and management of the land application of biosolids (sewage sludge) from the State Board of Health to the State Water Control Board effective January 1, 2008. As part of that action, the General Assembly also transferred the Board of Health Biosolids Use Regulations (12VAC5-585) to the State Water Control Board and directed that the regulations would remain in effect until action by the State Water Control Board.

The State Water Control Board adopted necessary amendments to its existing regulations to govern the land application of biosolids at its meeting on September 25, 2007. The amendments were published in the Virginia Register of Regulations in Volume 24, Issue 6 ([24:6 V.A.R. 700-806 November 26, 2007](#)) and became effective on January 1, 2008. In addition, the State Water Control Board repealed the State Board of Health Biosolids Use Regulations, 12VAC5-585, at its meeting on July 29, 2008.

Summary:

This action officially repeals the State Board of Health Biosolids Use Regulations (12VAC5-585), which have been superseded by State Water Control Board action and subsequently repealed by the State Water Control Board.

VA.R. Doc. No. R13-3388; Filed June 26, 2013, 3:58 p.m.

BOARD OF MEDICAL ASSISTANCE SERVICES

Fast-Track Regulation

Title of Regulation: **12VAC30-60. Standards Established and Methods Used to Assure High Quality Care (amending 12VAC30-60-140).**

Statutory Authority: § 32.1-325 of the Code of Virginia.

Public Hearing Information: No public hearings are scheduled.

Public Comment Deadline: August 28, 2013.

Effective Date: September 12, 2013.

Agency Contact: Brian McCormick, Regulatory Supervisor, Department of Medical Assistance Services, 600 East Broad Street, Suite 1300, Richmond, VA 23219, telephone (804) 371-8856, FAX (804) 786-1680, or email brian.mccormick@dmas.virginia.gov.

Basis: Section 32.1-325 of the Code of Virginia grants authority to the Board of Medical Assistance Services to administer and amend the Plan for Medical Assistance. Sections 32.1-324 and 32.1-325 of the Code of Virginia authorize the Director of the Department of Medical Assistance Services (DMAS) to administer and amend the Plan for Medical Assistance according to the board's requirements. The Medicaid authority as established by § 1902(a) of the Social Security Act (42 USC § 1396a) provides governing authority for payments for services.

Section 2.2-4012.1 of the Code of Virginia and Executive Order 14 (2010) permit DMAS to promulgate these regulatory changes as a fast-track action because these changes are expected to be noncontroversial, and the areas of agency discretion are minor.

Purpose: This regulatory change is not expected to affect the health, safety, or welfare of citizens of the Commonwealth nor of Medicaid recipients. It is intended to assist the agency with provider appeals by updating and clarifying current policies.

Pursuant to 42 CFR 440.260, the Commonwealth is required to provide in its State Plan for Medical Assistance a description of its methods and standards used to assure that services are of high quality.

The purpose of this action is to update the regulations consistent with current practice and procedures. DMAS is losing provider appeals because it has been performing these utilization reviews of rendered services instead of the Department of Behavioral Health and Developmental Services (formerly the Department of Mental Health, Mental Retardation and Substance Abuse Services). The current language has been outdated for quite some time due to changes in DMAS interagency agreement with this sister state agency.

Rationale for Using Fast-Track Process: This fast-track action is expected to be noncontroversial, and the areas of agency discretion are minor. It is irrelevant to providers which agency performs reviews of their services and claims.

Substance: The section of the State Plan for Medical Assistance that is affected by this action is Methods and Standards Used to Assure High Quality of Services (12VAC30-60-140).

Currently, 12VAC30-60-140 indicates that the "Department of Mental Health, Mental Retardation and Substance Abuse Services" conducts onsite utilization reviews of providers that render community mental health services. These providers are community-based behavioral health services providers. This action replaces "Department of Mental Health, Mental

Retardation and Substance Abuse Services" with "DMAS or its contractor" in 12VAC30-60-140 to reflect that DMAS conducts utilization reviews. The word "on-site" was removed to reflect that DMAS conducts utilization reviews not only onsite, but internally by reviewing provider documentation.

Issues: This regulatory action corrects language that is outdated and updates the agency's regulations with the current practice related to the entity that conducts utilization reviews. It will benefit the Commonwealth, the agency, and other officials to have the correct and current practice in regulations. There are no disadvantages.

Department of Planning and Budget's Economic Impact Analysis:

Summary of the Proposed Amendments to Regulation. The proposed changes will revise the regulatory language to reflect 1) that the Department of Medical Assistance Services or its contractor conducts utilization reviews of community mental health services rather than the Department of Mental Health, Mental Retardation and Substance Abuse Services, and 2) that the utilization reviews are not limited to on-site reviews only.

Result of Analysis. The benefits likely exceed the costs for all proposed changes.

Estimated Economic Impact. The proposed changes will revise the regulatory language to reflect that the Department of Medical Assistance Services (DMAS) or its contractor conducts utilization reviews of community mental health services rather than the Department of Mental Health, Mental Retardation and Substance Abuse Services and that the utilization reviews are not limited to on-site reviews only.

Utilization reviews have been conducted by DMAS since 2000 due to changes in the interagency agreement with its sister state agency. In addition, since 2001, utilization reviews are not limited to only on-site reviews and include desk reviews of rendered services. The proposed changes will merely update the regulatory language to reflect the procedures currently in practice. According to DMAS, there has been a surge in the number of provider appeals in this service area. In addition to improving the clarity of the regulations, the proposed regulatory language, which is consistent with current practices is expected to reduce the likelihood of DMAS losing a provider appeal.

Businesses and Entities Affected. The proposed regulations mainly apply to providers of community mental health services. There are approximately 700 such providers.

Localities Particularly Affected. The proposed regulations are not anticipated to affect any locality more than others.

Projected Impact on Employment. No direct impact on employment is expected.

Effects on the Use and Value of Private Property. No direct impact on the use and value of private property is expected.

Small Businesses: Costs and Other Effects. No direct costs or other effects on small businesses are expected. However, the proposed changes may reduce the likelihood that a community mental health services provider may win a utilization review appeal.

Small Businesses: Alternative Method that Minimizes Adverse Impact. There is no known alternative that minimizes the adverse impact while accomplishing the same goals.

Real Estate Development Costs. No impact on real estate development costs is expected.

Legal Mandate. The Department of Planning and Budget (DPB) has analyzed the economic impact of this proposed regulation in accordance with § 2.2-4007.04 of the Administrative Process Act and Executive Order Number 14 (10). Section 2.2-4007.04 requires that such economic impact analyses include, but need not be limited to, the projected number of businesses or other entities to whom the regulation would apply, the identity of any localities and types of businesses or other entities particularly affected, the projected number of persons and employment positions to be affected, the projected costs to affected businesses or entities to implement or comply with the regulation, and the impact on the use and value of private property. Further, if the proposed regulation has adverse effect on small businesses, § 2.2-4007.04 requires that such economic impact analyses include (i) an identification and estimate of the number of small businesses subject to the regulation; (ii) the projected reporting, recordkeeping, and other administrative costs required for small businesses to comply with the regulation, including the type of professional skills necessary for preparing required reports and other documents; (iii) a statement of the probable effect of the regulation on affected small businesses; and (iv) a description of any less intrusive or less costly alternative methods of achieving the purpose of the regulation. The analysis presented above represents DPB's best estimate of these economic impacts.

Agency's Response to Economic Impact Analysis: The agency concurs with the economic impact analysis prepared by the Department of Planning and Budget regarding the regulations concerning Technical Corrections for Utilization Review of Community Mental Health Rehabilitation Services (12VAC30-60-140).

Summary:

The amendments provide that (i) utilization reviews of community-based behavioral health services providers are conducted by the Department of Medical Assistance Services or its contractor rather than the Department of Behavioral Health and Developmental Services and (ii) utilization reviews are not limited to onsite reviews only.

12VAC30-60-140. Community mental health services.

A. Utilization review general requirements. ~~On-site utilization~~ Utilization reviews shall be conducted, at a

Regulations

minimum annually ~~at~~ for each enrolled provider, by the ~~state~~ Department of ~~Mental Health, Mental Retardation and Substance Abuse Services (DMHMRSAS)~~ Medical Assistance Services (DMAS) or its contractor. During each ~~on-site~~ review, an appropriate sample of the provider's total Medicaid population will be selected for review. An expanded review shall be conducted if an appropriate number of exceptions or problems are identified.

B. The ~~DMHMRSAS~~ review by DMAS or its contractor shall include the following items:

1. Medical or clinical necessity of the delivered service;
2. The admission to service and level of care was appropriate;
3. The services were provided by appropriately qualified individuals as defined in the Amount, Duration, and Scope of Services found in ~~12VAC30-50-220~~ 12VAC30-50; and
4. Delivered services as documented are consistent with recipients' Individual Service Plans, invoices submitted, and specified service limitations.

VA.R. Doc. No. R13-3022; Filed July 8, 2013, 10:10 a.m.

DEPARTMENT OF BEHAVIORAL HEALTH AND DEVELOPMENTAL SERVICES

Fast-Track Regulation

Title of Regulation: **12VAC35-220. Certification Requirements for Early Intervention Professionals and Early Intervention Specialists (amending 12VAC35-220-10, 12VAC35-220-30, 12VAC35-220-50, 12VAC35-220-80, 12VAC35-220-90; adding 12VAC35-220-35).**

Statutory Authority: § 2.2-5304 of the Code of Virginia.

Public Hearing Information: No public hearings are scheduled.

Public Comment Deadline: August 28, 2013.

Effective Date: September 12, 2013.

Agency Contact: Catherine Hancock, Part C Administrator, Department of Behavioral Health and Developmental Services, 1220 Bank Street, Richmond, VA 23218-1797, telephone (804) 371-6592, FAX (804) 371-7959, or email catherine.hancock@dbhds.virginia.gov.

Basis: Section 2.2-5304 of the Code of Virginia authorizes the Board of Behavioral Health and Developmental Services to promulgate regulations and adopt the policies and procedures as necessary to implement an early intervention services system. Chapter 890 of the 2011 Acts of Assembly (Budget Bill Item 304 Q) requires the Department of Behavioral Health and Developmental Services, in consultation with the Department of Medical Assistance Services, to promulgate regulations to certify early intervention case managers to provide case management services to Medicaid and FAMIS children enrolled in early intervention services provided under Part C of the Individuals with Disabilities Education Act (IDEA) of 2004.

Purpose: These regulations provide specific requirements for certification of early intervention case managers under Virginia's early intervention services system, as required by Public Law 108-446 and the standards established in 42 CFR 431.51. Section 2.2-5304 of the Code of Virginia designates the department as the state lead agency responsible for implementing Virginia's early intervention services system and ensuring compliance with the applicable federal requirements. The goal of these regulations is to ensure the competence of early intervention case managers under the authority granted to the lead agency. The regulations also provide the basis for the department to certify qualified individuals to coordinate the early intervention services and supports provided to children and their families and allow these individuals to receive reimbursement for the coordination services provided under the Medicaid State Plan § 1902a (42 USC § 1396a). The department consulted with the public, providers, and other state agencies, including the Department of Medical Assistance Services, in developing these regulations.

Rationale for Using Fast-Track Process: The regulations (i) provide practitioners the opportunity to qualify for Medicaid reimbursement and (ii) reflect federal and state requirements. Nearly 390 individuals have been certified as early intervention case managers under emergency regulations that became effective February 1, 2012. The Virginia Interagency Coordinating Council supports adoption of permanent regulations.

Adoption of permanent regulations will permit individuals providing care coordination for the early intervention service system to pursue certification and allow currently certified early intervention case managers to continue receiving reimbursement for services performed and to accumulate the additional educational credentials required for certification renewal.

Substance: The substantive provisions of the regulation include:

1. A definition of early intervention case management and a requirement for specified providers of this service under the Medicaid State Plan to be certified by the department;
2. Specific criteria for practitioners to be certified as early intervention case managers;
3. Application process requirements for initial certification, recertification, and the restoration of an expired certification; and
4. Processes for practitioners to seek reconsideration of a decision to deny certification.

Issues: This action poses no disadvantages to the public or the Commonwealth. These regulations establish a certification process for early intervention case managers that assures individuals completing the certification process are appropriately and adequately prepared and trained to coordinate services to infant and toddlers with disabilities.

The regulations establish the criteria for maintenance of the certification, which allows practitioners to seek reimbursement for services rendered.

Department of Planning and Budget's Economic Impact Analysis:

Summary of the Proposed Amendments to Regulation. Pursuant to Virginia Code 2.2-5304 and Chapter 890 of the 2011 Virginia Acts of Assembly (Budget Bill Item 304#Q), the State Board of Behavioral Health and Developmental Services (Board) proposes to establish the certification requirements for early intervention case managers.

Result of Analysis. The benefits likely exceed the costs for all proposed changes.

Estimated Economic Impact. The current emergency regulations governing the certification requirements of early intervention case managers have been in effect since February 1, 2012. As of July 2012, 389 professionals have been certified as early intervention case managers with no identified regulatory problems. The Board proposes no changes to the emergency regulations that are currently in force.

The regulations provide practitioners the opportunity to qualify for Medicaid reimbursement and reflect federal and state requirements. The proposed regulations help provide funding for services for children age three and younger by establishing reasonable certification requirements. Thus, the proposed regulations produce a net benefit.

Businesses and Entities Affected. The proposed amendments affect the approximately 70 small businesses that provide early intervention services in the Commonwealth, as well as the children and families for whom they provide services.

Localities Particularly Affected. The proposed amendments do not disproportionately affect particular localities.

Projected Impact on Employment. The proposed amendments may positively affect employment at the approximately 70 small businesses that provide early intervention services in the Commonwealth.

Effects on the Use and Value of Private Property. The proposed amendments may moderately increase the value of the approximately 70 small businesses that provide early intervention services in the Commonwealth.

Small Businesses: Costs and Other Effects. The proposed amendments do not add costs for small businesses.

Small Businesses: Alternative Method that Minimizes Adverse Impact. The proposed amendments do not adversely affect small businesses.

Real Estate Development Costs. The proposed amendments will not affect real estate development costs.

Legal Mandate. The Department of Planning and Budget (DPB) has analyzed the economic impact of this proposed regulation in accordance with § 2.2-4007.04 of the Administrative Process Act and Executive Order Number 14

(10). Section 2.2-4007.04 requires that such economic impact analyses include, but need not be limited to, the projected number of businesses or other entities to whom the regulation would apply, the identity of any localities and types of businesses or other entities particularly affected, the projected number of persons and employment positions to be affected, the projected costs to affected businesses or entities to implement or comply with the regulation, and the impact on the use and value of private property. Further, if the proposed regulation has adverse effect on small businesses, § 2.2-4007.04 requires that such economic impact analyses include (i) an identification and estimate of the number of small businesses subject to the regulation; (ii) the projected reporting, recordkeeping, and other administrative costs required for small businesses to comply with the regulation, including the type of professional skills necessary for preparing required reports and other documents; (iii) a statement of the probable effect of the regulation on affected small businesses; and (iv) a description of any less intrusive or less costly alternative methods of achieving the purpose of the regulation. The analysis presented above represents DPB's best estimate of these economic impacts.

Agency's Response to Economic Impact Analysis: The agency concurs with the economic impact analysis prepared by the Department of Planning and Budget.

Summary:

Pursuant to Item 304 Q of Chapter 890 of the 2011 Acts of Assembly, these regulations establish requirements for the certification of early intervention case managers who may provide early intervention services and support to children and their families under the federal Part C program.

CHAPTER 220

CERTIFICATION REQUIREMENTS FOR EARLY INTERVENTION PROFESSIONALS ~~AND~~ EARLY INTERVENTION SPECIALISTS, AND EARLY INTERVENTION CASE MANAGERS

12VAC35-220-10. Authority and applicability.

A. Pursuant to § 2.2-5304 of the Code of Virginia, the Governor has designated the Department of Behavioral Health and Developmental Services as the state lead agency responsible for implementing the Virginia early intervention services system and ensuring compliance with federal requirements. These regulations are necessary to ensure the competence for early intervention services system practitioners under the authority granted to the lead agency.

B. Individual providers of early intervention services under the Medicaid State Plan must be certified by the Department of Behavioral Health and Developmental Services as qualified to provide certain early intervention ~~professionals or early intervention specialists~~ services. These regulations provide certification requirements for these early intervention ~~professionals and early intervention specialists~~ providers.

Regulations

12VAC35-220-30. Certification required for the provision of early intervention services professionals and early intervention specialists.

A. Individual practitioners of early intervention services, with the exception of physicians, audiologists, and registered dietitians, shall be certified by the department as early intervention professionals or early intervention specialists.

B. Certified early intervention professionals shall have expertise in a discipline trained to enhance the development of children with a disability, as evidenced by state licensure, including application for state licensure if the discipline authorizes practice in Virginia while the application is pending and the individual practitioner meets all applicable requirements for such practice; state endorsement; or certification by a national professional organization. Qualified personnel in the following disciplines may seek certification from the department as early intervention professionals:

1. Counselors:

- a. Licensed professional counselors licensed by the Virginia Board of Counseling; and
- b. School counselors (Pre K - 12) endorsed by the Virginia Board of Education;

2. Educators:

- a. Educators licensed by the Virginia Board of Education with endorsement in Special Education - Early Childhood (Birth - 5);
- b. Educators licensed by the Virginia Board of Education with endorsement in Early/Primary Education (Pre K - 3);
- c. Educators licensed by the Virginia Board of Education with endorsement in Career and Technical Education - Family and Consumer Services;
- d. Educators licensed by the Virginia Board of Education with endorsement in Special Education - Hearing Impairments (Pre K - 12);
- e. Educators licensed by the Virginia Board of Education with endorsement in Special Education - Visual Impairments (Pre K - 12); and
- f. Educators with a technical professional license issued by the Virginia Board of Education in Career and Technical Education - Family and Consumer Sciences;

3. Family and consumer science professionals certified through the American Association of Family and Consumer Sciences (AAFCS). Individuals certified by the AAFCS after June 30, 2009, shall meet certification requirements in family and consumer sciences - human development and family studies;

4. Marriage and family therapists licensed by the Virginia Board of Counseling;

5. Music therapists certified by the Certification Board for Music Therapists (CBMT);

6. Nurses:

- a. Nurse practitioners licensed by the Virginia Board of Nursing; and
- b. Registered nurses licensed by the Virginia Board of Nursing;

7. Occupational therapists licensed by the Virginia Board of Medicine;

8. Orientation and mobility specialists certified by the National Blindness Professional Certification Board as a National Orientation and Mobility Certificant (NOMC) or certified by the Academy for Certification of Vision Rehabilitation and Education Professionals (ACVREP) as a Certified Orientation and Mobility Specialist (COMS);

9. Physical therapists licensed by the Virginia Board of Physical Therapy;

10. Psychologists:

- a. Applied psychologists licensed by the Virginia Board of Psychology;
- b. Clinical psychologists licensed by the Virginia Board of Psychology; and
- c. School psychologists licensed by the Virginia State Board of Education with an endorsement in school psychology;

11. Social workers:

- a. Licensed clinical social workers licensed by the Virginia Board of Social Work; and
- b. School social workers licensed by the Virginia State Board of Education with an endorsement as a school social worker;

12. Speech-language pathologists licensed by the Virginia Board of Audiology and Speech-Language Pathology; and

13. Therapeutic recreation specialists certified by the National Council on Therapeutic Recreation.

C. Certified early intervention specialists shall hold a minimum of a high school diploma or general equivalency diploma. Qualified personnel in the following disciplines may seek certification from the department as early intervention specialists:

1. Early intervention assistants whose qualifications have been approved by the Department of Behavioral Health and Developmental Services;

2. Licensed social workers licensed by the Virginia Board of Social Work;

3. Nurses:

- a. Certified nurse aides certified by the Virginia Board of Nursing; and
- b. Licensed practical nurses licensed by the Virginia Board of Nursing;

4. Occupational therapy assistants licensed by the Virginia Board of Medicine; and

5. Physical therapy assistants licensed by the Virginia Board of Physical Therapy.

D. Certified early intervention professionals and certified early intervention specialists shall demonstrate knowledge of early intervention principles and practices, including infant and toddler development, family-centered practice and multidisciplinary team practice, by successful completion of the early intervention principles and practices online training modules administered by the department. A score of at least 80% accuracy on each module's competency test shall be required for successful completion.

12VAC35-220-35. Certification required for early intervention case managers.

A. Individual practitioners of case management services who provide service coordination to children enrolled in early intervention services shall be certified by the department as early intervention case managers.

B. Certified early intervention case managers shall hold:

1. A minimum of a bachelor's degree in any of the following fields:

- a. Allied health, including rehabilitation counseling, recreation therapy, occupational therapy, physical therapy, or speech or language pathology;
- b. Child and family studies;
- c. Counseling;
- d. Early childhood;
- e. Early childhood growth and development;
- f. Early childhood special education;
- g. Human development;
- h. Human services;
- i. Nursing;
- j. Psychology;
- k. Public health;
- l. Social work;
- m. Special education - hearing impairments;
- n. Special education - visual impairments; or
- o. Other related field or interdisciplinary studies approved by the department;

2. An associate degree in a related field such as occupational therapy assistant, physical therapy assistant, or nursing; or

3. A high school diploma or general equivalency diploma, or an undergraduate degree in an unrelated field, plus three years experience coordinating direct services to children and families and implementing individual service plans. Direct services address issues related to developmental and physical disabilities, behavioral health or educational needs, or medical conditions. Experience may include supervised internships, practicums, or other field placements.

C. Qualified persons shall demonstrate:

1. Expertise in the provision of case management services, as evidenced by successful completion of training approved by the department. A score of at least 80% accuracy on the training competency test or tests shall be required for successful completion.

2. Knowledge of early intervention principles and practices, including infant and toddler development and family-centered practice and multidisciplinary team practice, as evidenced by successful completion of the early intervention principles and practices online training modules administered by the department. A score of at least 80% accuracy on each module's competency test shall be required for successful completion.

12VAC35-220-50. Initial certification and recertification processes.

A. Initial certification. To apply for initial certification as an early intervention professional ~~or~~, early intervention specialist, or early intervention case manager, practitioners shall:

- 1. Obtain the designated early intervention certification application package from the department; and
- 2. Submit a completed and signed application package to the department with:
 - a. A signed assurance that the practitioner will comply with all federal and state early intervention requirements;
 - b. Documentation of the practitioner's educational credentials, professional certification, licensing, endorsement, or other qualification for the practice of his profession in the Commonwealth of Virginia; and
 - c. Documentation of the practitioner's successful completion of the ~~early intervention principles and practices~~ training ~~administered~~ required by the department.

Any initial certification granted to individuals who have made application for state licensure and are awaiting licensure shall be valid only as long as that individual meets the requirements of their discipline to practice in Virginia.

B. Three-year recertification. At least 30 days prior to the expiration of the practitioner's certification period, ~~the certified early intervention professionals and certified early intervention specialists~~ practitioner shall submit an application for recertification to the department. This application shall include:

- 1. Documentation of the practitioner's continuing professional certification, licensing, endorsement, or other qualification for the practice of his profession in the Commonwealth of Virginia, and
- 2. Documentation that the practitioner has successfully completed at least 30 hours of continuing learning activities during the three-year certification period. The continuing learning activities shall address one or more of

Regulations

the following: (i) evidenced-based practices in early intervention services; (ii) changes in federal or state law, regulations, or practice requirements; (iii) topics identified on a personal development plan; ~~and~~ (iv) training needed for new responsibilities relating to early intervention services; ~~and~~ (v) training required by the department. For each continuing learning activity, documentation shall include a description of the activity and sponsoring organization, if applicable; the date or dates of training; the number of hours; and a copy of a certificate or verification of attendance, if applicable.

12VAC35-220-80. Restoration of expired certifications.

A. The department shall notify practitioners in writing of the date their certification ~~as an early intervention professional or early intervention specialist~~ expired and that the practitioner has been placed on inactive status in the practitioner database maintained by the department.

B. Practitioners whose certification ~~as early intervention professionals or early intervention specialists~~ has expired may apply to the department for restoration of their certifications.

C. The department may restore certification for practitioners ~~as early intervention professionals or early intervention specialists~~ under the following conditions:

1. The individual's certification has been lapsed for a period of less than one year; and

2. The certification:

a. Has lapsed because the practitioner failed to complete the three-year recertification requirements and the individual provides documentation to the department demonstrating (i) he is currently qualified for the practice of his discipline or profession in the Commonwealth of Virginia, and (ii) he has completed at least 30 hours of training addressing one or more of the topics specified in 12VAC35-220-50 B 2; or

b. Has lapsed because the practitioner's discipline or profession-specific qualification expired and the practitioner documents that he now holds a current license, certification, endorsement, or other qualification for the practice of his discipline or profession in the Commonwealth of Virginia.

D. The department shall provide written notice of the decision on reinstatement of the practitioner's certification within 30 days of the receipt of a completed request and required documentation.

E. Upon restoration of the practitioner's certification ~~as an early intervention professional or early intervention specialist~~, the department shall reinstate the individual's active status in the practitioner database maintained by the department.

12VAC35-220-90. Termination of ~~early intervention professional or early intervention specialist~~ certification.

A. The department shall terminate a practitioner's certification ~~as an early intervention professional or early intervention specialist~~ under the following circumstances:

1. The practitioner's discipline-specific license, certification, or endorsement has been suspended or terminated;

2. The practitioner, after a year, fails to comply with the recertification requirements set forth in these regulations; or

3. The practitioner fails to comply with his signed assurance that he will comply with all federal and state early intervention requirements.

B. The department shall notify the practitioner in writing of the date of and reason for termination and that the practitioner has been removed from the practitioner database maintained by the department.

VA.R. Doc. No. R12-2761; Filed July 9, 2013, 11:13 a.m.



TITLE 13. HOUSING

BOARD OF HOUSING AND COMMUNITY DEVELOPMENT

Proposed Regulation

REGISTRAR'S NOTICE: The Board of Housing and Community Development is claiming an exemption from the Administrative Process Act pursuant to § 2.2-4006 A 12 of the Code of Virginia, which excludes regulations adopted pursuant to § 36-98.3 of the Code of Virginia.

Title of Regulation: 13VAC5-31. Virginia Amusement Device Regulations (amending 13VAC5-31-20, 13VAC5-31-30, 13VAC5-31-40, 13VAC5-31-60, 13VAC5-31-75, 13VAC5-31-200, 13VAC5-31-210, 13VAC5-31-290).

Statutory Authority: § 36-98.3 of the Code of Virginia.

Public Hearing Information:

September 23, 2013 - 10 a.m. - Virginia Housing Center, 4224 Cox Road, Glen Allen, VA

Public Comment Deadline: September 29, 2013.

Agency Contact: Stephen W. Calhoun, Regulatory Coordinator, Department of Housing and Community Development, Main Street Centre, 600 East Main Street, Suite 300, Richmond, VA 23219, telephone (804) 371-7000, FAX (804) 371-7090, TTY (804) 371-7089, or email steve.calhoun@dhcd.virginia.gov.

Background: The Virginia Amusement Device Regulations (VADR) govern the construction and operation of amusement devices, which are defined by statute as devices or structures open to the public by which persons are conveyed or moved

in an unusual manner for diversion and passenger tramways. The regulations are very closely related to the Virginia Uniform Statewide Building Code (USBC), 13VAC5-63, as, also by statutory arrangement, the USBC applies to amusement devices to the extent that they are not superseded by the VADR. The VADR utilizes nationally recognized standards to provide the technical requirements for the construction and operation of amusement devices. The standards are produced by the American Society for Testing and Materials (ASTM). To coincide with the updating of its other building and fire regulations, the Board of Housing and Community Development initiates a regulatory action under the VADR to consider changes necessary to correlate with the Department of Housing and Community Development's other building and fire regulations and to adopt available newer ASTM standards.

Summary:

Specific changes in the proposed regulation are as follows:

1. 13VAC5-31-20 A:

a. In the definition of "amusement device," clarifies the phrase "open to the public" to facilitate a more uniform application of the VADR.

b. Adds a definition of the phrase "certificate of inspection" to mean the certificate or sticker for amusement devices distributed by the department, as referenced in 13VAC5-31-75 E. This amendment requires the use of the department sticker where previously a locality was permitted to use its own.

c. Changes the term "kiddie ride" to "small mechanical ride" and revises the criteria for what qualifies as a small mechanical ride. This amendment is in conjunction with new requirements for inspections in 13VAC5-31-75 D that limit the permit period to a maximum of six months for small mechanical rides.

2. 13VAC5-31-30 A: *Adds this subsection to assist local building departments in determining whether certain devices are amusement devices and to achieve more uniformity in the application of the regulation.*

3. 13VAC5-31-30 B: *Expands the list of exempted equipment or devices.*

4. 13VAC5-31-40 A: *Updates the list of incorporated standards.*

5. 13VAC5-31-75 A: *Increases the amount a locality must reduce a permit fee when a private inspector is used, from 50% to 75%; increases permit fees for amusement rides; and adds language permitting the increase of fees by a local building department for weekend or after-hour inspections.*

6. 13VAC5-31-75 D: *Adds language on (i) the minimum time frame for notifying local building departments prior to the operation of a small mechanical ride or an inflatable amusement device, (ii) the inspection fee that a local building department may charge per event where an*

inflatable amusement device is operating, and (iii) the inspection report required for such inspections.

7. 13VAC5-31-75 E: *Clarifies that a local building department may authorize a third-party inspector to post the certification sticker and that permits for small mechanical rides are only valid for a maximum of six months.*

8. 13VAC5-31-75 J: *Adds this subsection to clarify the procedures for violations of the chapter.*

9. 13VAC5-31-75 K: *Adds this subsection to clarify that the Virginia Department of General Services functions as the local building department for amusement devices located on state-owned property.*

13VAC5-31-20. Definitions.

A. The following words and terms when used in this chapter shall have the following meanings unless the context clearly indicates otherwise:

"Amusement device" means (i) a device or structure open to the public by which persons are conveyed or moved in an unusual manner for diversion, but excluding snow tubing parks and rides, ski terrain parks, ski slopes, and ski trails, and (ii) passenger tramways. For the purpose of this definition, the phrase "open to the public" means that the public has full access to a device or structure at an event, irrespective of whether a fee is charged. The use of devices or structures at private events is not considered to be open to the public.

"Bungee cord" means the elastic rope to which the jumper is attached which lengthens and shortens to produce a bouncing action.

"Carabineer" means a shaped metal device with a gate used to connect sections of a bungee cord, jump rigging, equipment, or safety gear.

"Certificate of inspection" means the certificate or sticker for amusement devices distributed by DHCD.

"DHCD" means the Virginia Department of Housing and Community Development.

"Gravity ride" means a ride that is installed on an inclined surface, which depends on gravity for its operation to convey a passenger from the top of the incline to the bottom, and which conveys a passenger in or on a carrier tube, bag, bathing suit, or clothes.

"Ground operator" means a person who assists the jump master to prepare a jumper for jumping.

"Harness" means an assembly to be worn by a bungee jumper to be attached to a bungee cord. It is designed to prevent the wearer from becoming detached from the bungee system.

"Jump master" means a person who has responsibility for the bungee jumper and who takes the jumper through the final stages to the actual jump.

Regulations

"Jump zone" means the space bounded by the maximum designed movements of the bungee jumper.

"Jumper" means the person who departs from a height attached to a bungee system.

~~"Kiddie ride" means an amusement device where the passenger or patron height is limited to 54 inches or less, the design capacity of passengers or patrons is 12 or less, and the assembly time for the device is two hours or less.~~

"Landing area" means the surface area of ground or water directly under the jump zone, the area where the lowering device moves the bungee jumper to be landed away from the jump space and the area covered by the movement of the lowering device.

"Local building department" means the agency or agencies of the governing body of any city, county or town in this Commonwealth charged with the enforcement of the USBC.

"Operating manual" means the document that contains the procedures and forms for the operation of bungee jumping equipment and activity at a site.

"Passenger tramway" means a device used to transport passengers uphill, and suspended in the air by the use of steel cables, chains or belts, or ropes, and usually supported by trestles or towers with one or more spans.

"Platform" means the equipment attached to the structure from which the bungee jumper departs.

"Private inspector" means a person performing inspections who is independent of the company, individual or organization owning, operating or having any vested interest in an amusement device being inspected.

"Small mechanical ride" means an amusement device, other than an inflatable amusement device, where (i) the assembly time for the device is two hours or less, (ii) the revolutions per minute of any rotation of the components of the device is not greater than seven, (iii) the device has a footprint of less than 500 square feet, and (iv) the device does not invert a patron or lift a patron more than three feet in the air, measured from the ground to the bottom of the patron's feet when the device is operating.

"Ultimate tensile strength" means the greatest amount of load applied to a bungee cord prior to failure.

"USBC" means the Virginia Uniform Statewide Building Code (13VAC5-63).

B. Words and terms used in this chapter which are defined in the USBC shall have the meaning ascribed to them in that regulation unless the context clearly indicates otherwise.

C. Words and terms used in this chapter which are defined in the standards incorporated by reference in this chapter shall have the meaning ascribed to them in those standards unless the context clearly indicates otherwise.

13VAC5-31-30. Exemptions Devices covered and exempt.

A. The following devices, identified by name or description, when open to the public shall be considered amusement

devices subject to this chapter. The list is intended only to clarify questionable devices, while the definition of an "amusement device" in 13VAC5-31-20 is generally used to determine the applicability of this chapter.

1. Inflatable amusement devices; and

2. Zip lines.

B. The following equipment or devices shall not be considered amusement devices subject to this chapter:

1. Nonmechanized playground or recreational equipment such as swing sets, sliding boards, climbing bars, jungle gyms, skateboard ramps and similar equipment where no admission fee is charged for its use or for admittance to areas where the equipment is located;

2. Coin-operated rides designed to accommodate three or less passengers; ~~and~~

3. Water slides or similar equipment used in community association, community club or community organization swimming pools; ~~and~~

4. Mechanical bulls or similar devices;

5. Devices known as mall trains, shopping mall trains, or electric trackless trains for malls; and

6. Devices known as water walking balls, euro bubbles, or similar devices.

13VAC5-31-40. Incorporated standards.

A. The following standards are hereby incorporated by reference for use as part of this chapter:

1. American National Standards Institute (ANSI) Standard No. ~~B77.1-2006~~ B77.1-2011 for the regulation of passenger tramways; and

2. American Society for Testing and Materials (ASTM) Standard Nos. F698-94 (~~Reapproved 2000~~), F747-06, ~~F770-06a~~ F770-11, F846-92 (~~Reapproved 2003~~) (2009), F853-05, ~~F893-05a, F1159-03a~~ F893-10, F1159-11, F1193-06, F1305-94 (~~Reapproved 2002~~), ~~F1950-99, F1957-99~~ (~~Reapproved 2004~~) (2011), ~~F2007-06, F2137-09, F2291-09b, F2374-07a, F2376-06~~ F2007-11, F2137-11, F2291-11, F2374-10, F2375-09, F2376-08, and F2460-06 ~~F2460-11~~ for the regulation of amusement devices.

The standards referenced above may be procured from:

ANSI	ASTM
25 W 43rd Street	100 Barr Harbor Dr.
New York, NY	West Conshohocken, PA
10036	19428-2959

B. The provisions of this chapter govern where they are in conflict with any provisions of the standards incorporated by reference in this chapter.

C. The following requirements supplement the provisions of the ASTM standards incorporated by reference in this chapter:

1. The operator of an amusement device shall be at least 16 years of age, except when the person is under the supervision of a parent or guardian and engaged in activities determined not to be hazardous by the Commissioner of the Virginia Department of Labor and Industry;

2. The amusement device shall be attended by an operator at all times during operation except that (i) one operator is permitted to operate two or more amusement devices provided they are within the sight of the operator and operated by a common control panel or station and (ii) one operator is permitted to operate two kiddie small mechanical rides with separate controls provided the distance between controls is no more than 35 feet and the controls are equipped with a positive pressure switch; and

3. The operator of an amusement device shall not be (i) under the influence of any drugs which may affect the operator's judgment or ability to assure the safety of the public or (ii) under the influence of alcohol.

D. Where an amusement device was manufactured under previous editions of the standards incorporated by reference in this chapter, the previous editions shall apply to the extent that they are different from the current standards.

13VAC5-31-60. Appeals.

Appeals from the local building department concerning the application of this chapter shall be made to the local board of building code appeals established by the USBC. Application for appeal shall be filed with the local building department within 14 calendar days after receipt of the decision of the local building department. The board of appeals shall hear the appeal within seven calendar days after the application for appeal is filed. After final determination by the board, any person who was a party to the appeal may appeal to the State Building Code Technical Review Board, established under § 36-108 of the Code of Virginia, within 14 calendar days of receipt of the decision to be appealed. Such appeal shall be in accordance with the procedures established in the USBC, under the authority granted by § 36-98.3 of the Code of Virginia where the provisions of Chapter 6 (§ 36-97 et seq.) of Title 36 of the Code of Virginia and the USBC apply to amusement devices.

NOTE: Because of the short time frames normally associated with amusement device operations, DHCD staff will be available to assist in finding a timely resolution to disagreements between owners or operators and the local building department upon request by either party.

Part II

Enforcement, Permits and Certificates of Inspection

13VAC5-31-75. Local building department.

A. In accordance with §§ 36-98.3 and 36-105 of the Code of Virginia, the local building department shall be responsible for the enforcement of this chapter and may charge fees for such enforcement activity. The total amount charged for any

one permit to operate an amusement device or devices or the renewal of such permit shall not exceed the following, except that when a private inspector is used, the fees shall be reduced by ~~50%~~ 75%:

1. ~~\$25~~ \$35 for each kiddie small mechanical ride or inflatable amusement device covered by the permit;

2. ~~\$35~~ \$55 for each circular ride or flat-ride less than 20 feet in height covered by the permit;

3. ~~\$55~~ \$75 for each spectacular ride covered by the permit that cannot be inspected as a circular ride or flat-ride in subdivision 2 of this subsection due to complexity or height; and

4. ~~\$150~~ \$200 for each coaster covered by the permit that exceeds 30 feet in height.

Notwithstanding the above, the local building department shall be permitted to increase the fees up to 50% when requested to perform weekend or after-hour inspections.

B. Notwithstanding the provisions of subsection A of this section, when an amusement device is constructed in whole or in part at a site for permanent operation at that site and is not intended to be disassembled and moved to another site, then the local building department may utilize permit and inspection fees established pursuant to the USBC to defray the cost of enforcement. This authorization does not apply to an amusement device that is only being reassembled, undergoing a major modification at a site or being moved to a site for operation.

C. A permit application shall be made to the local building department at least five days before the date in which the applicant intends to operate an amusement device. The application shall include the name of the owner, operator or other person assuming responsibility for the device or devices, a general description of the device or devices including any serial or identification numbers available, the location of the property on which the device or devices will be operated and the length of time of operation. The permit application shall indicate whether a private inspector will be utilized. If a private inspector is not utilized, the applicant shall give reasonable notice when an inspection is sought and may stipulate the day such inspection is requested provided it is during the normal operating hours of the local building department. In addition to the information required on the permit application, the applicant shall provide proof of liability insurance of an amount not less than \$1,000,000 per occurrence or proof of equivalent financial responsibility. The local building department shall be notified of any change in the liability insurance or financial responsibility during the period covered by the permit.

D. Notwithstanding the provisions of subsection C of this section, a permit application is not required for a kiddie small mechanical ride or an inflatable amusement device that has ~~an unexpired~~ a certificate of inspection issued by any local building department in this Commonwealth within a one-year

Regulations

period prior to the dates the small mechanical ride or inflatable amusement device is to be used, regardless of whether the device has been disassembled and moved to a new site. In such cases, the local building department shall be notified at least three days prior to the operation of the ~~kiddie~~ small mechanical ride or the inflatable amusement device and the information required on a permit application as listed in subsection C of this section shall be provided to the local building department. In addition, and notwithstanding the provisions of subsection A of this section, the local building department shall be permitted to charge a \$50 inspection fee per event to the person notifying the local building department of an event where an inflatable amusement device is operating, if the local building department chooses to inspect any or all of the inflatable amusement devices operating at that event. An inspection report shall be provided to the person notifying the local building department of the event if such an inspection is conducted.

E. Local building department personnel shall examine the permit application within five days and issue the permit if all requirements are met. A certificate of inspection for each amusement device shall be issued when the device has been found to comply with this chapter by a private inspector or by an inspector from the local building department. It shall be the responsibility of the local building department to verify that the private inspector possesses a valid certificate of competence as an amusement device inspector from the Virginia Board of Housing and Community Development. In addition, local building department personnel shall be responsible for assuring that the certificate of inspection is posted or affixed on or in the vicinity of the device in a location visible to the public. Local building department personnel shall post or affix such certificates or permit the certificates to be posted or affixed by the private inspector. Permits shall indicate the length of time the device or devices will be operated at the site, clearly identify the device or devices to which it applies and the date of expiration of the permit. Permits shall not be valid for longer than one year, except that permits for small mechanical rides shall not be valid for longer than six months.

F. In addition to obtaining a certificate of inspection in conjunction with a permit application for amusement devices permanently fixed to a site, a new certificate of inspection shall also be obtained prior to the operation of an amusement device following a major modification, prior to each seasonal operation of a device, at least once during the operating season and prior to resuming the operation of a device following an order from a local building department to cease operation. This requirement shall not apply to ~~kiddie~~ small mechanical rides meeting the conditions outlined in subsection D of this section.

G. For amusement devices manufactured prior to 1978, the owner or operator shall have the information required by §§ 2.1 through 2.6 of ASTM F698 available at the time of inspection. In addition, the operator of any amusement device

shall be responsible for obtaining all manufacturer's notifications, service bulletins and safety alerts issued pursuant to ASTM F853 and the operator shall comply with all recommendations and requirements set out in those documents. A copy of all such documents shall be made available during an inspection.

H. In the enforcement of this chapter, local building department personnel shall have authority to conduct inspections at any time an amusement device would normally be open for operation or at any other time if permission is granted by the owner or operator, to issue an order to temporarily cease operation of an amusement device upon the determination that the device may be unsafe or may otherwise endanger the public and to accept and approve or deny requests for modifications of the rules of this chapter in accordance with the modification provisions of the USBC.

I. In accordance with subdivision 7 of § 36-137 of the Code of Virginia, the local building department shall collect a 2.0% levy of fees charged for permits under this chapter and transmit it quarterly to DHCD to support training programs of the Virginia Building Code Academy. Localities that maintain individual or regional training academies accredited by DHCD shall retain such levy.

J. In accordance with § 36-98.3 of the Code of Virginia and 13VAC5-31-10 B, the procedures for violations of this chapter shall be prescribed in the USBC.

K. In accordance with § 36-98.1 of the Code of Virginia, the Virginia Department of General Services (DGS) shall function as the local building department for the application of this chapter to amusement devices located on state-owned property. In accordance with §§ 36-98.2 and 36-114 of the Code of Virginia, appeals of the application of this chapter by the DGS shall be made directly to the State Building Code Technical Review Board. Further, as a condition of this chapter, such appeals shall be filed within 14 calendar days after receipt of the decision of DGS.

Part V

Inflatable Amusement Devices

13VAC5-31-200. General requirements.

In addition to other applicable requirements of this chapter, inflatable amusement devices shall be operated, maintained and inspected in accordance with ASTM F2374.

~~Notwithstanding any requirements of this chapter to the contrary, a permit to operate an inflatable amusement device that is less than 150 square feet and in which the height of the patron containment area is less than 10 feet need not be obtained if the device has an unexpired certificate of inspection issued by a local building department in this Commonwealth, regardless of whether the device has been disassembled or moved to a new site.~~

Part VI
Artificial Climbing Walls

13VAC5-31-210. General requirements.

In addition to other applicable requirements of this chapter, artificial climbing walls shall be operated, maintained and inspected in accordance with ASTM F1159.

Notwithstanding any requirements of this chapter to the contrary, an artificial climbing wall may be moved, setup and operated without obtaining a permit provided the wall has a valid certificate of inspection issued by a local building department in this Commonwealth within the prior 90 days and the expiration date of the wire ropes used with the device does not expire within that 90-day period.

13VAC5-31-290. Requirements.

Amusement devices subject to this part shall comply with applicable requirements of 36 CFR Part 1191—Americans With Disabilities Act (ADA) Accessibility Guidelines for Buildings and Facilities and; Architectural Barriers Act (ABA) Accessibility Guidelines; (69 FR 44151-44455 (July 23, 2004)).

DOCUMENTS INCORPORATED BY REFERENCE
(13VAC5-31)

ANSI B77.1-2011, Passenger Ropeways – Aerial Tramways, Aerial Lifts, Surface Lifts, Tows and Conveyors – Safety Requirements, American National Standards Institute (ANSI), 25 West 43rd Street, 4th Floor, New York, NY 10036 (<http://www.ansi.org/>)

American Society for Testing and Materials (ASTM), 100 Barr Harbor Drive, West Conshohocken, PA 19428-2959; (<http://www.astm.org/>):

~~F 698—94 (Reapproved 2000) ASTM F698-94, Standard Specification for Physical Information to be Provided for Amusement Rides and Devices, ASTM International, West Conshohocken, PA 19428~~

~~F 747—06 ASTM F747-06, Standard Terminology Relating to Amusement Rides and Devices, ASTM International, West Conshohocken, PA 19428~~

~~F 770—06a ASTM F770-11, Standard Practice for Ownership and Operation of Amusement Rides and Devices, ASTM International, West Conshohocken, PA 19428~~

~~F 846—92 (Reapproved 2003) ASTM F846-92 (2009), Standard Guide for Testing Performance of Amusement Rides and Devices, ASTM International, West Conshohocken, PA 19428~~

~~F 853—05 ASTM F853-05, Standard Practice for Maintenance Procedures for Amusement Rides and Devices, ASTM International, West Conshohocken, PA 19428~~

~~F 893—05a ASTM F893-10, Standard Guide for Inspection of Amusement Rides and Devices, ASTM International, West Conshohocken, PA 19428~~

~~F 1159—03a ASTM F1159-11, Standard Practice for Design and Manufacture of Patron Directed, Artificial Climbing Walls, Dry Slide, Coin Operated and Purposeful Water Immersion Amusement Rides and Devices and Air-Supported Structures, ASTM International, West Conshohocken, PA 19428~~

~~F 1193—06 ASTM F1193-06, Standard Practice for Quality, Manufacture, and Construction of Amusement Rides and Devices, ASTM International, West Conshohocken, PA 19428~~

~~F 1305—94 (Reapproved 2002), Standard Guide for Classification of Amusement Rides and Device Related Injuries and Illnesses, ASTM International, West Conshohocken, PA 19428~~

~~F 1950—99, Standard Specification for Physical Information to be Transferred With Used Amusement Rides and Devices, ASTM International, West Conshohocken, PA 19428~~

~~F 1957—99 (Reapproved 2004) ASTM F1957-99 (2011), Standard Test Method for Composite Foam Hardness-Durometer Hardness, ASTM International, West Conshohocken, PA 19428~~

~~F 2007—06 ASTM F2007-11, Standard Practice for Classification, Design, Manufacture, and Operation of Concession Go-Karts and Facilities, ASTM International, West Conshohocken, PA 19428~~

~~F 2137—09 ASTM F2137-11, Standard Practice for Measuring the Dynamic Characteristics of Amusement Rides and Devices, ASTM International, West Conshohocken, PA 19428~~

~~F 2291—09b ASTM F2291-11, Standard Practice for Design of Amusement Rides and Devices, ASTM International, West Conshohocken, PA 19428~~

~~F 2374—07a ASTM F2374-10, Standard Practice for Design, Manufacture, Operation, and Maintenance of Inflatable Amusement Devices, ASTM International, West Conshohocken, PA 19428~~

~~ASTM F2375-09, Standard Practice for Design, Manufacture, Installation and Testing of Climbing Nets and Netting/Mesh used in Amusement Rides, Devices, Play Areas and Attractions~~

~~F 2376—06 ASTM F2376-08, Standard Practice for Classification, Design, Manufacture, Construction, and Operation of Water Slide Systems, ASTM International, West Conshohocken, PA 19428~~

~~F 2460—06 ASTM F2460-11, Standard Practice for Special Requirements for Bumper Boats, ASTM International, West Conshohocken, PA 19428~~

~~B 77.1—06, Passenger Ropeways—Aerial Tramways, Aerial Lifts, Surface Lifts, Tows and Conveyors—Safety Requirements, ANSI, New York, NY 10036~~

VA.R. Doc. No. R12-3160; Filed June 27, 2013; 9:53 a.m.

Regulations

Proposed Regulation

REGISTRAR'S NOTICE: The Board of Housing and Community Development is claiming an exemption from the Administrative Process Act pursuant to § 2.2-4006 A 12 of the Code of Virginia, which excludes regulations adopted by the board pursuant to the Statewide Fire Prevention Code (§ 27-94 et seq. of the Code of Virginia).

Title of Regulation: 13VAC5-51. Virginia Statewide Fire Prevention Code (amending 13VAC5-51-21, 13VAC5-51-31, 13VAC5-51-41, 13VAC5-51-61, 13VAC5-51-81, 13VAC5-51-85, 13VAC5-51-91, 13VAC5-51-111, 13VAC5-51-121, 13VAC5-51-130, 13VAC5-51-131, 13VAC5-51-132, 13VAC5-51-133, 13VAC5-51-133.5, 13VAC5-51-135, 13VAC5-51-140, 13VAC5-51-145, 13VAC5-51-150, 13VAC5-51-154, 13VAC5-51-155; adding 13VAC5-51-138; repealing 13VAC5-51-154.5).

Statutory Authority: § 27-97 of the Code of Virginia.

Public Hearing Information:

September 23, 2013 - 10 am - Virginia Housing Center, 4224 Cox Road, Glen Allen, VA

Public Comment Deadline: September 29, 2013.

Agency Contact: Stephen W. Calhoun, Regulatory Coordinator, Department of Housing and Community Development, Main Street Centre, 600 East Main Street, Suite 300, Richmond, VA 23219, telephone (804) 371-7000, FAX (804) 371-7090, TTY (804) 371-7089, or email steve.calhoun@dhcd.virginia.gov.

Background: The Virginia Statewide Fire Prevention Code (SFPC) governs the maintenance of fire-safety features in existing buildings and structures and fire-safety related operations on property. The SFPC incorporates by reference the International Fire Code (IFC), a nationally recognized model code produced by the International Code Council as a companion code to that used under the Virginia Uniform Statewide Building Code (13VAC5-63). Every three years, a new edition of the model code becomes available. At that time, the Board of Housing and Community Development initiates a regulatory action to incorporate the newer edition of the model code into the regulation through the publishing of a proposed regulation.

Summary:

Specific changes in the proposed regulation are outlined below:

1. 13VAC5-51-21 H: Deletes the reference to section 3413 to correlate with changes to the Uniform Statewide Building Code (USBC). Section 3413 of the USBC is for the retrofitting of existing buildings in accordance with state law and those provisions have been moved to a new rehabilitation code portion of the USBC.
2. 13VAC5-51-31 A: Updates the reference to the IFC from the 2009 to the 2012 edition, which is the new nationally recognized model code used in the SFPC.

3. 13VAC5-51-61 C: Clarifies the existing requirement for accepting reports from private or third-party inspectors and references a written policy established by the fire official.

4. 13VAC5-51-81 N: Permits an increase in the fees charged by the State Fire Marshal's Office when there are firework events and the operator fails to notify the office within the appropriate lead time to facilitate inspections.

5. 13VAC5-51-85 Q: Adds an option for the electronic submittal of information necessary to obtain operational permits.

6. 13VAC5-51-111 B: Adds language to alert those affected by enforcement actions of a right to appeal, with limited exceptions.

7. 13VAC5-51-121 M: Adds language to match a statutory requirement that actions under local fire prevention regulations may be appealed to the State Building Code Technical Review Board if the locality does not have a local appeals board designated to hear such appeals.

8. 13VAC5-51-131 C: Adds language to clarify that the unauthorized removal of a placard constitutes a violation of the code.

9. 13VAC5-51-135 E: Adds language to correlate with the fire extinguisher requirements in both the IFC and the USBC.

10. 13VAC5-51-150 V: Adds new requirements for the use of fireworks known as comets and mines. The requirements are based on the fireworks standard of the National Fire Protection Association.

Other changes are for clarification or correlation or to avoid duplication.

13VAC5-51-21. Section 102.0. Applicability.

A. 102.1. General: The provisions of the SFPC shall apply to all matters affecting or relating to structures, processes and premises as set forth in Section 101.0. The SFPC shall supersede any fire prevention regulations previously adopted by a local government or other political subdivision.

B. 102.1.1. Changes: No change shall be made in the use or occupancy of any structure that would place the structure in a different division of the same group of occupancies, unless such structure is made to comply with the requirements of this code and the USBC.

C. 102.2. Application to pre-1973 buildings and structures: Buildings and structures constructed prior to the USBC (1973) shall comply with the maintenance requirements of the SFPC to the extent that equipment, systems, devices, and safeguards which were provided and approved when constructed shall be maintained. Such buildings and structures, if subject to the state fire and public building regulations (Virginia Public Building Safety Regulations, VR

394-01-05) in effect prior to March 31, 1986, shall also be maintained in accordance with those regulations.

D. 102.3. Application to post-1973 buildings and structures: Buildings and structures constructed under any edition of the USBC shall comply with the maintenance requirements of the SFPC to the extent that equipment, systems, devices, and safeguards which were provided and approved when constructed shall be maintained.

E. 102.4. Referenced codes and standards: The codes and standards referenced in the IFC shall be those listed in Chapter 47 ~~80~~ and considered part of the requirements of the SFPC to the prescribed extent of each such reference. Where differences occur between the provisions of this code and the referenced standards, the provisions of this code shall apply.

F. 102.5. State-owned buildings and structures: The SFPC shall be applicable to all state-owned buildings and structures in the manner and extent described in § 27-99 of the Code of Virginia and the State Fire Marshal shall have the authority to enforce this code in state-owned buildings and structures as is prescribed in §§ 27-98 and 27-99 of the Code of Virginia.

G. 102.6. Relationship to USBC: In accordance with §§ 27-34.4, 36-105.1 and 36-119.1 of the Code of Virginia, the USBC does not supersede the provisions of this code that prescribe standards to be complied with in existing buildings and structures, provided that this code shall not impose requirements that are more restrictive than those of the USBC under which the buildings or structures were constructed. Subsequent alteration, enlargement, rehabilitation, repair or conversion of the occupancy classification of such buildings and structures shall be subject to the construction and rehabilitation provisions of the USBC. Inspection of buildings other than state-owned buildings under construction and the review and approval of building plans for these structures for enforcement of the USBC shall be the sole responsibility of the appropriate local building inspectors.

Upon completion of such structures, responsibility for fire safety protection shall pass to the local fire marshal or official designated by the locality to enforce this code in those localities that enforce the SFPC or to the State Fire Marshal in those localities that do not enforce this code.

H. 102.7. Inspections for USBC requirements: The fire official shall require that existing structures subject to the requirements of the applicable retrofitting provisions relating to the fire protection equipment and system requirements of the USBC, Part I, Construction, ~~Sections Section~~ 103.7 and 3413, comply with the provisions located therein.

13VAC5-51-31. Section 103.0. Incorporation by reference.

A. 103.1. General: The following document is adopted and incorporated by reference to be an enforceable part of the SFPC:

The International Fire Code -- ~~2009~~ 2012 Edition, hereinafter referred to as "IFC," published by the International Code Council, Inc., 500 New Jersey Avenue,

NW, 6th Floor, Washington, DC 20001-2070, 1-888 422-7233.

B. 103.1.1. Deletion: Delete IFC Chapter 1.

C. 103.1.2. Appendices: The appendices in the IFC are not considered part of the IFC for the purposes of Section 103.1.

Note: Section 101.5 references authority contained in the Code of Virginia for local fire prevention regulations that may be evaluated by localities to determine whether provisions in the IFC appendices may be considered for local fire prevention regulations.

D. 103.2. Amendments: All requirements of the referenced codes and standards that relate to fees, permits, unsafe notices, disputes, condemnation, inspections, scope of enforcement and all other procedural, and administrative matters are deleted and replaced by the provisions of Chapter 1 of the SFPC.

E. 103.2.1. Other amendments: The SFPC contains provisions adopted by the Virginia Board of Housing and Community Development (BHCD), some of which delete, change or amend provisions of the IFC and referenced standards. Where conflicts occur between such changed provisions and the unchanged provisions of the IFC and referenced standards, the provisions changed by the BHCD shall govern.

Note: The IFC and its referenced standards contain some areas of regulation outside of the scope of the SFPC, as established by the BHCD and under state law. Where conflicts have been readily noted, changes have been made to the IFC and its referenced standards to bring it within the scope of authority; however, in some areas, judgment will have to be made as to whether the provisions of the IFC and its referenced standards are fully applicable.

F. 103.3. International Fire Code. Retroactive fire protection system requirements contained in the IFC shall not be enforced unless specified by the USBC.

13VAC5-51-41. Section 104.0. Enforcement.

A. 104.1. Local enforcement: Any local government may enforce the SFPC following official action by such body. The official action shall (i) require compliance with the provisions of the SFPC in its entirety or with respect only to those provisions of the SFPC relating to open burning, fire lanes, fireworks, and hazardous materials and (ii) assign enforcement responsibility to the local agency or agencies of its choice. Any local governing body may establish such procedures or requirements as may be necessary for the administration and enforcement of this code. If a local governing body elects to enforce only those provisions of the SFPC relating to open burning, it may do so in all or in any designated geographic areas of its jurisdiction. The terms "enforcing agency" and "fire official" are intended to apply to the agency or agencies to which responsibility for enforcement of the SFPC has been assigned. The terms "building official" or "building department" are intended to

Regulations

apply only to the local building official or local building department.

B. 104.1.1. Enforcement of fireworks provisions by law-enforcement officers: In accordance with § 27-100.1 of the Code of Virginia, law-enforcement officers who are otherwise authorized to enforce certain provisions of this code shall not be subject to the certification requirements of Sections 105.2 or 105.3.2.

C. 104.2. State enforcement:

In accordance with § 27-98 of the Code of Virginia, the State Fire Marshal shall also have the authority, in cooperation with any local governing body, to enforce the SFPC. The State Fire Marshal shall also have authority to enforce the SFPC in those jurisdictions in which the local governments do not enforce the SFPC and may establish such procedures or requirements as may be necessary for the administration and enforcement of the SFPC in such jurisdictions.

D. 104.3. State structures: Every agency, commission or institution of this Commonwealth, including all institutions of higher education, shall permit, at all reasonable hours, the fire official reasonable access to existing structures or a structure under construction or renovation, for the purpose of performing an informational and advisory fire safety inspection. The fire official is permitted to submit, subsequent to performing such inspection, his findings and recommendations, including a list of corrective actions necessary to ensure that such structure is reasonably safe from the hazards of fire, to the appropriate official of such agency, commission, or institution and the State Fire Marshal. Such agency, commission or institution shall notify, within 60 days of receipt of such findings and recommendations, the State Fire Marshal and the fire official of the corrective measures taken to eliminate the hazards reported by the fire official. The State Fire Marshal shall have the same power in the enforcement of this section as is provided for in § 27-98 of the Code of Virginia. The State Fire Marshal may enter into an agreement as is provided for in § ~~36-139.4~~ 9.1-208 of the Code of Virginia with any local enforcement agency that enforces the SFPC to enforce this section and to take immediate enforcement action upon verification of a complaint of an imminent hazard such as a chained or blocked exit door, improper storage of flammable liquids, use of decorative materials, and overcrowding.

13VAC5-51-61. Section 106.0. Duties and powers of the fire official.

A. 106.1. General: The fire official shall enforce the provisions of the SFPC as provided herein and as interpreted by the State Building Code Technical Review Board (TRB) in accordance with § 36-118 of the Code of Virginia.

B. 106.2. Delegation of duties and powers: The fire official may delegate duties and powers subject to any limitations imposed by the local governing body. The fire official shall

be responsible that any powers and duties delegated are carried out in accordance with this code.

C. 106.3. Inspections: The fire official is authorized to conduct such inspections as are deemed necessary to determine the extent of compliance with the provisions of this code and to approve reports of inspection by approved agencies or individuals in accordance with the fire official's written policy. All reports of such inspections by approved agencies or individuals shall be prepared and submitted in writing for review and approval. Inspection reports shall be certified by a responsible officer of such approved agency or by the responsible individual. The fire official is authorized to engage such expert opinion as deemed necessary to report upon unusual, detailed or complex technical issues in accordance with local policies.

D. 106.3.1. Observations: When, during an inspection, the fire official or an authorized representative observes an apparent or actual violation of another law, ordinance or code not within the official's authority to enforce, such official shall report the findings to the official having jurisdiction in order that such official may institute the necessary measures.

E. 106.4. Alternatives: The SFPC provisions are not intended to prevent the use of any safeguards used to protect life and property from the hazards of fire or explosion that are not specifically prescribed by the SFPC, provided that such alternative safeguards comply with the intent of the SFPC. The alternative safeguard offered shall be, for the purpose intended, at least the equivalent of that prescribed in this code in quality, strength, effectiveness, fire resistance, durability and safety.

F. 106.5. Modifications: The fire official may grant modifications to any provision of the SFPC upon application by the owner or the owner's agent provided the spirit and intent of the SFPC are observed and public health, welfare, and safety are assured.

Note: The current editions of many nationally recognized model codes and standards are referenced by the SFPC. Future amendments to such codes and standards do not automatically become part of the SFPC; however, the fire official should consider such amendments in deciding whether a modification request should be granted.

G. 106.5.1. Supporting data: The fire official shall require that sufficient technical data be submitted to substantiate the proposed use of any alternative. If it is determined that the evidence presented is satisfactory proof of performance for the use intended, the fire official shall approve the use of such alternative subject to the requirements of this code. The fire official may require and consider a statement from a professional engineer, architect or other competent person as to the equivalency of the proposed modification.

H. 106.5.2. Decision: The application for modification and the final decision of the fire official shall be in writing and shall be recorded in the permanent records of the local enforcing agency.

I. 106.6. Notices and orders: The fire official shall issue all necessary notices or orders to ensure compliance with the SFPC.

J. 106.7. Department records: The fire official shall keep official records of applications received, permits and certificates issued, fees collected, reports of inspections, and notices and orders issued. Such records shall be retained in the official records or disposed of in accordance with General Schedule Number Ten available from The Library of Virginia.

13VAC5-51-81. Section 107.0. Permits and fees.

A. 107.1. Prior notification: The fire official may require notification prior to (i) activities involving the handling, storage or use of substances, materials or devices regulated by the SFPC; (ii) conducting processes which produce

conditions hazardous to life or property; or (iii) establishing a place of assembly.

B. 107.2. Permits required: Permits may be required by the fire official as permitted under the SFPC in accordance with Table 107.2, except that the fire official shall require permits for the manufacturing, storage, handling, use, and sale of explosives. In accordance with Section ~~3301.2.3.1~~ 5601.2.3.1, an application for a permit to manufacture, store, handle, use, or sell explosives shall only be made by a designated individual.

Exception: Such permits shall not be required for the storage of explosives or blasting agents by the Virginia Department of State Police provided notification to the fire official is made annually by the Chief Arson Investigator listing all storage locations.

C. Add Table 107.2 as follows:

Table 107.2. OPERATIONAL PERMIT REQUIREMENTS (to be filled in by local jurisdiction).			
Description	Permit Required (yes or no)	Permit Fee	Inspection Fee
Aerosol products. An operational permit is required to manufacture, store or handle an aggregate quantity of Level 2 or Level 3 aerosol products in excess of 500 pounds (227 kg) net weight.			
Amusement buildings. An operational permit is required to operate a special amusement building.			
Aviation facilities. An operational permit is required to use a Group H or Group S occupancy for aircraft servicing or repair and aircraft fuel-servicing vehicles. Additional permits required by other sections of this code include, but are not limited to, hot work, hazardous materials and flammable or combustible finishes			
Carnivals and fairs. An operational permit is required to conduct a carnival or fair.			
Battery systems. An operational permit is required to install stationary lead-acid battery systems having a liquid capacity of more than 50 gallons (189 L).			
Cellulose nitrate film. An operational permit is required to store, handle or use cellulose nitrate film in a Group A occupancy.			
Combustible dust-producing operations. An operational permit is required to operate a grain elevator, flour starch mill, feed mill, or a plant pulverizing aluminum, coal, cocoa, magnesium, spices or sugar, or other operations producing combustible dusts as defined in Chapter 2.			
Combustible fibers. An operational permit is required for the storage and handling of combustible fibers in quantities greater than 100 cubic feet (2.8 m ³). Exception: An operational permit is not required for agricultural storage.			

Regulations

<p>Compressed gas. An operational permit is required for the storage, use or handling at normal temperature and pressure (NTP) of compressed gases in excess of the amounts listed below.</p> <p>Exception: Vehicles equipped for and using compressed gas as a fuel for propelling the vehicle.</p> <p style="text-align: center;">Permit Amounts for Compressed Gases</p> <table border="1" style="width: 100%; border-collapse: collapse;"> <thead> <tr> <th style="text-align: left;">Type of Gas</th> <th style="text-align: left;">Amount (cubic feet at NTP)</th> </tr> </thead> <tbody> <tr> <td>Corrosive</td> <td>200</td> </tr> <tr> <td>Flammable (except cryogenic fluids and liquefied petroleum gases)</td> <td>200</td> </tr> <tr> <td>Highly toxic</td> <td>Any Amount</td> </tr> <tr> <td>Inert and simple asphyxiant</td> <td>6,000</td> </tr> <tr> <td>Oxidizing (including oxygen)</td> <td>504</td> </tr> <tr> <td>Toxic</td> <td>Any Amount</td> </tr> </tbody> </table> <p>For SI: 1 cubic foot = 0.02832 m³.</p>	Type of Gas	Amount (cubic feet at NTP)	Corrosive	200	Flammable (except cryogenic fluids and liquefied petroleum gases)	200	Highly toxic	Any Amount	Inert and simple asphyxiant	6,000	Oxidizing (including oxygen)	504	Toxic	Any Amount				
Type of Gas	Amount (cubic feet at NTP)																	
Corrosive	200																	
Flammable (except cryogenic fluids and liquefied petroleum gases)	200																	
Highly toxic	Any Amount																	
Inert and simple asphyxiant	6,000																	
Oxidizing (including oxygen)	504																	
Toxic	Any Amount																	
<p>Covered mall buildings. An operational permit is required for:</p> <ol style="list-style-type: none"> 1. The placement of retail fixtures and displays, concession equipment, displays of highly combustible goods and similar items in the mall. 2. The display of liquid-fired or gas-fired equipment in the mall. 3. The use of open-flame or flame-producing equipment in the mall. 																		
<p>Cryogenic fluids. An operational permit is required to produce, store, transport on site, use, handle or dispense cryogenic fluids in excess of the amounts listed below.</p> <p>Exception: Operational permits are not required for vehicles equipped for and using cryogenic fluids as a fuel for propelling the vehicle or for refrigerating the lading.</p> <p style="text-align: center;">Permit Amounts for Cryogenic Fluids</p> <table border="1" style="width: 100%; border-collapse: collapse;"> <thead> <tr> <th style="text-align: left;">Type of Cryogenic Fluid</th> <th style="text-align: left;">Inside Building (gallons)</th> <th style="text-align: left;">Outside Building (gallons)</th> </tr> </thead> <tbody> <tr> <td>Flammable</td> <td>More than 1</td> <td>60</td> </tr> <tr> <td>Inert</td> <td>60</td> <td>500</td> </tr> <tr> <td>Oxidizing (includes oxygen)</td> <td>10</td> <td>50</td> </tr> <tr> <td>Physical or health hazard not indicated above</td> <td>Any Amount</td> <td>Any Amount</td> </tr> </tbody> </table> <p>For SI: 1 gallon = 3.785 L.</p>	Type of Cryogenic Fluid	Inside Building (gallons)	Outside Building (gallons)	Flammable	More than 1	60	Inert	60	500	Oxidizing (includes oxygen)	10	50	Physical or health hazard not indicated above	Any Amount	Any Amount			
Type of Cryogenic Fluid	Inside Building (gallons)	Outside Building (gallons)																
Flammable	More than 1	60																
Inert	60	500																
Oxidizing (includes oxygen)	10	50																
Physical or health hazard not indicated above	Any Amount	Any Amount																
<p>Cutting and welding. An operational permit is required to conduct cutting or welding operations within the jurisdiction.</p>																		

<p>Dry cleaning plants. An operational permit is required to engage in the business of dry cleaning or to change to a more hazardous cleaning solvent used in existing dry cleaning equipment.</p>			
<p>Exhibits and trade shows. An operational permit is required to operate exhibits and trade shows.</p>			
<p>Explosives. An operational permit is required for the manufacture, storage, handling, sale or use of any quantity of explosive, explosive material, fireworks, or pyrotechnic special effects within the scope of Chapter 33 <u>56</u>.</p>			
<p>Fire hydrants and valves. An operational permit is required to use or operate fire hydrants or valves intended for fire suppression purposes that are installed on water systems and accessible to a fire apparatus access road that is open to or generally used by the public.</p> <p>Exception: An operational permit is not required for authorized employees of the water company that supplies the system or the fire department to use or operate fire hydrants or valves.</p>			
<p>Flammable and combustible liquids. An operational permit is required:</p> <ol style="list-style-type: none"> 1. To use or operate a pipeline for the transportation within facilities of flammable or combustible liquids. This requirement shall not apply to the offsite transportation in pipelines regulated by the Department of Transportation (DOTn) (see § 3501.1.2) nor does it apply to piping systems (see § 3503.6). 2. To store, handle or use Class I liquids in excess of 5 gallons (19 L) in a building or in excess of 10 gallons (37.9 L) outside of a building, except that a permit is not required for the following: <ol style="list-style-type: none"> 2.1. The storage or use of Class I liquids in the fuel tank of a motor vehicle, aircraft, motorboat, mobile power plant or mobile heating plant, unless such storage, in the opinion of the fire official, would cause an unsafe condition. 2.2. The storage or use of paints, oils, varnishes or similar flammable mixtures when such liquids are stored for maintenance, painting or similar purposes for a period of not more than 30 days. 3. To store, handle or use Class II or Class IIIA liquids in excess of 25 gallons (95 L) in a building or in excess of 60 gallons (227 L) outside a building, except for fuel oil used in connection with oil-burning equipment. 4. To remove Class I or Class II liquids from an underground storage tank used for fueling motor vehicles by any means other than the approved, stationary on-site pumps normally used for dispensing purposes. 5. To operate tank vehicles, equipment, tanks, plants, terminals, wells, fuel-dispensing stations, refineries, distilleries and similar facilities where flammable and combustible liquids are produced, processed, transported, stored, dispensed or used. 6. To install, alter, remove, abandon, place temporarily out of service (for more than 90 days) or otherwise dispose of an underground, protected above-ground or above-ground flammable or combustible liquid tank. 7. To change the type of contents stored in a flammable or 			

Regulations

<p>combustible liquid tank to a material that poses a greater hazard than that for which the tank was designed and constructed.</p> <p>8. To manufacture, process, blend or refine flammable or combustible liquids.</p>																																													
<p>Floor finishing. An operational permit is required for floor finishing or surfacing operations exceeding 350 square feet (33 m²) using Class I or Class II liquids.</p>																																													
<p>Fruit and crop ripening. An operational permit is required to operate a fruit- or crop-ripening facility or conduct a fruit-ripening process using ethylene gas.</p>																																													
<p>Fumigation and thermal insecticidal fogging. An operational permit is required to operate a business of fumigation or thermal insecticidal fogging and to maintain a room, vault or chamber in which a toxic or flammable fumigant is used.</p>																																													
<p>Hazardous materials. An operational permit is required to store, transport on site, dispense, use or handle hazardous materials in excess of the amounts listed below.</p> <p style="text-align: center;">Permit Amounts for Hazardous Materials</p> <table border="0" style="width: 100%;"> <thead> <tr> <th style="text-align: left;">Type of Material</th> <th style="text-align: left;">Amount</th> </tr> </thead> <tbody> <tr> <td>Combustible liquids</td> <td>See flammable and combustible liquids</td> </tr> <tr> <td>Corrosive materials</td> <td></td> </tr> <tr> <td> Gases</td> <td>See compressed gases</td> </tr> <tr> <td> Liquids</td> <td>55 gallons</td> </tr> <tr> <td> Solids</td> <td>1000 pounds</td> </tr> <tr> <td>Explosive materials</td> <td>See explosives</td> </tr> <tr> <td>Flammable materials</td> <td></td> </tr> <tr> <td> Gases</td> <td>See compressed gases</td> </tr> <tr> <td> Liquids</td> <td>See flammable and combustible liquids</td> </tr> <tr> <td> Solids</td> <td>100 pounds</td> </tr> <tr> <td>Highly toxic materials</td> <td></td> </tr> <tr> <td> Gases</td> <td>See compressed gases</td> </tr> <tr> <td> Liquids</td> <td>Any amount</td> </tr> <tr> <td> Solids</td> <td>Any amount</td> </tr> <tr> <td>Oxidizing materials</td> <td></td> </tr> <tr> <td> Gases</td> <td>See compressed gases</td> </tr> <tr> <td> Liquids</td> <td></td> </tr> <tr> <td> Class 4</td> <td>Any amount</td> </tr> <tr> <td> Class 3</td> <td>1 gallon</td> </tr> <tr> <td> Class 2</td> <td>10 gallons</td> </tr> </tbody> </table>	Type of Material	Amount	Combustible liquids	See flammable and combustible liquids	Corrosive materials		Gases	See compressed gases	Liquids	55 gallons	Solids	1000 pounds	Explosive materials	See explosives	Flammable materials		Gases	See compressed gases	Liquids	See flammable and combustible liquids	Solids	100 pounds	Highly toxic materials		Gases	See compressed gases	Liquids	Any amount	Solids	Any amount	Oxidizing materials		Gases	See compressed gases	Liquids		Class 4	Any amount	Class 3	1 gallon	Class 2	10 gallons			
Type of Material	Amount																																												
Combustible liquids	See flammable and combustible liquids																																												
Corrosive materials																																													
Gases	See compressed gases																																												
Liquids	55 gallons																																												
Solids	1000 pounds																																												
Explosive materials	See explosives																																												
Flammable materials																																													
Gases	See compressed gases																																												
Liquids	See flammable and combustible liquids																																												
Solids	100 pounds																																												
Highly toxic materials																																													
Gases	See compressed gases																																												
Liquids	Any amount																																												
Solids	Any amount																																												
Oxidizing materials																																													
Gases	See compressed gases																																												
Liquids																																													
Class 4	Any amount																																												
Class 3	1 gallon																																												
Class 2	10 gallons																																												

Class 1	55 gallons			
Solids				
Class 4	Any amount			
Class 3	10 pounds			
Class 2	100 pounds			
Class 1	500 pounds			
Organic peroxides				
Liquids				
Class I	Any amount			
Class II	Any amount			
Class III	1 gallon			
Class IV	2 gallons			
Class V	No permit required			
Solids				
Class I	Any amount			
Class II	Any amount			
Class III	10 pounds			
Class IV	20 pounds			
Class V	No permit required			
Pyrophoric materials				
Gases	See compressed gases			
Liquids	Any amount			
Solids	Any amount			
Toxic materials				
Gases	See compressed gases			
Liquids	10 gallons			
Solids	100 pounds			
Unstable (reactive) materials				
Liquids				
Class 4	Any amount			
Class 3	Any amount			
Class 2	5 gallons			
Class 1	10 gallons			
Solids				
Class 4	Any amount			
Class 3	Any amount			

Regulations

Class 2	50 pounds			
Class 1	100 pounds			
Water reactive materials				
Liquids				
Class 3	Any amount			
Class 2	5 gallons			
Class 1	55 gallons			
Solids				
Class 3	Any amount			
Class 2	50 pounds			
Class 1	500 pounds			
For SI: 1 gallon = 3.785 L, 1 pound = 0.454 kg.				
HPM facilities. An operational permit is required to store, handle or use hazardous production materials.				
High piled storage. An operational permit is required to use a building or portion thereof as a high-piled storage area exceeding 500 square feet (46 m ²).				
Hot work operations. An operational permit is required for hot work including, but not limited to: 1. Public exhibitions and demonstrations where hot work is conducted. 2. Use of portable hot work equipment inside a structure. Exception: Work that is conducted under a construction permit. 3. Fixed-site hot work equipment such as welding booths. 4. Hot work conducted within a hazardous fire area. 5. Application of roof coverings with the use of an open-flame device. 6. When approved, the fire official shall issue a permit to carry out a Hot Work Program. This program allows approved personnel to regulate their facility's hot work operations. The approved personnel shall be trained in the fire safety aspects denoted in this chapter and shall be responsible for issuing permits requiring compliance with the requirements found in this chapter. These permits shall be issued only to their employees or hot work operations under their supervision.				
Industrial ovens. An operational permit is required for operation of industrial ovens regulated by Chapter 24 <u>30</u> .				
Lumber yards and woodworking plants. An operational permit is required for the storage or processing of lumber exceeding 100,000 board feet (8,333 ft ³) (236 m ³).				
Liquid- <u>fueled</u> or gas- <u>fueled</u> vehicles or equipment in assembly buildings. An operational permit is required to display, operate or demonstrate liquid- <u>fueled</u> or gas- <u>fueled</u> vehicles or equipment in assembly buildings.				
LP-gas. An operational permit is required for: 1. Storage and use of LP-gas.				

Exception: An operational permit is not required for individual containers with a 500-gallon (1893 L) water capacity or less serving occupancies in Group R-3. 2. Operation of cargo tankers that transport LP-gas.			
Magnesium. An operational permit is required to melt, cast, heat treat or grind more than 10 pounds (4.54 kg) of magnesium.			
Miscellaneous combustible storage. An operational permit is required to store in any building or upon any premises in excess of 2,500 cubic feet (71 m ³) gross volume of combustible empty packing cases, boxes, barrels or similar containers, rubber tires, rubber, cork or similar combustible material.			
Open burning. An operational permit is required for the kindling or maintaining of an open fire or a fire on any public street, alley, road, or other public or private ground. Instructions and stipulations of the permit shall be adhered to. Exception: Recreational fires.			
Open flames and candles. An operational permit is required to remove paint with a torch; use a torch or open-flame device in a hazardous fire area; or to use open flames or candles in connection with assembly areas, dining areas of restaurants or drinking establishments.			
Organic coatings. An operational permit is required for any organic-coating manufacturing operation producing more than 1 gallon (4 L) of an organic coating in one day.			
Assembly/educational. An operational permit is required to operate a place of assembly/educational occupancy.			
Private fire hydrants. An operational permit is required for the removal from service, use or operation of private fire hydrants. Exception: An operational permit is not required for private industry with trained maintenance personnel, private fire brigade or fire departments to maintain, test and use private hydrants.			
Pyrotechnic special effects material. An operational permit is required for use and handling of pyrotechnic special effects material.			
Pyroxylin plastics. An operational permit is required for storage or handling of more than 25 pounds (11 kg) of cellulose nitrate (pyroxylin) plastics and for the assembly or manufacture of articles involving pyroxylin plastics.			
Refrigeration equipment. An operational permit is required to operate a mechanical refrigeration unit or system regulated by Chapter 6.			
Repair garages and service stations. An operational permit is required for operation of repair garages and automotive, marine and fleet service stations.			
Rooftop heliports. An operational permit is required for the operation of a rooftop heliport.			
Spraying or dipping. An operational permit is required to conduct a spraying or dipping operation utilizing flammable or combustible liquids or the application of combustible powders regulated by			

Regulations

Chapter 45 <u>24</u> .			
Storage of scrap tires and tire byproducts. An operational permit is required to establish, conduct or maintain storage of scrap tires and tire byproducts that exceeds 2,500 cubic feet (71 m ³) of total volume of scrap tires and for indoor storage of tires and tire byproducts.			
Temporary membrane structures and tents. An operational permit is required to operate an air-supported temporary membrane structure or a tent. Exceptions: 1. Tents used exclusively for recreational camping purposes. 2. Tents and air-supported structures that cover an area of 900 square feet (84 m ²) or less, including all connecting areas or spaces with a common means of egress or entrance and with an occupant load of 50 or less persons.			
Tire-rebuilding plants. An operational permit is required for the operation and maintenance of a tire-rebuilding plant.			
Waste handling. An operational permit is required for the operation of wrecking yards, junk yards and waste material-handling facilities.			
Wood products. An operational permit is required to store chips, hogged material, lumber or plywood in excess of 200 cubic feet (6 m ³).			

D. 107.3. Application for permit: Application for a permit shall be made on forms prescribed by the fire official.

E. 107.4. Issuance of permits: Before a permit is issued, the fire official shall make such inspections or tests as are necessary to assure that the use and activities for which application is made comply with the provisions of this code.

F. 107.5. Conditions of permit: A permit shall constitute permission to store or handle materials or to conduct processes in accordance with the SFPC, and shall not be construed as authority to omit or amend any of the provisions of this code. Permits shall remain in effect until revoked or for such period as specified on the permit. Permits are not transferable.

G. 107.5.1. Special conditions for the State Fire Marshal's office. Permits issued by the State Fire Marshal's office for the use of explosives in special operations or under emergency conditions shall be valid for one week from the date of issuance and shall not be renewable.

H. 107.6. State Fire Marshal: Permits will not be required by the State Fire Marshal except for those permits listed in Sections 107.13 and 107.14 of this code.

Exception: Such permits shall not be required for the storage of explosives or blasting agents by the Virginia Department of State Police provided notification to the State Fire Marshal is made annually by the Chief Arson Investigator listing all storage locations within areas where enforcement is provided by the State Fire Marshal's office.

I. 107.7. Annual: The enforcing agency may issue annual permits for the manufacturing, storage, handling, use, or sales of explosives to any state regulated public utility.

J. 107.8. Approved plans: Plans approved by the fire official are approved with the intent that they comply in all respects to this code. Any omissions or errors on the plans do not relieve the applicant of complying with all applicable requirements of this code.

K. 107.9. Posting: Issued permits shall be kept on the premises designated therein at all times and shall be readily available for inspection by the fire official.

L. 107.10. Suspension of permit: A permit shall become invalid if the authorized activity is not commenced within six months after issuance of the permit, or if the authorized activity is suspended or abandoned for a period of six months after the time of commencement.

~~M. 107.11. Revocation of permit: The fire official may revoke a permit or approval issued under the SFPC if conditions of the permit have been violated, or if the approved application, data or plans contain misrepresentation as to material fact.~~

~~N. M.~~ 107.12. Local fees: In accordance with § 27-97 of the Code of Virginia, fees may be levied by the local governing body in order to defray the cost of enforcement and appeals under the SFPC.

~~O. N.~~ 107.13. State Fire Marshal's office permit fees for explosives, blasting agents, theatrical flame effects, and fireworks: Applications Except as modified herein.

applications for firework or pyrotechnic displays shall be submitted to and received by the State Fire Marshal's office not less than 15 days prior to the planned event. Fees for permits issued by the State Fire Marshal's office for the storage, use, sale or manufacture of explosives or blasting agents, and for the display of fireworks and flame effects on state-owned property shall be as follows:

1. \$125 per year per magazine to store explosives and blasting agents.
2. \$200 per year per city or county to use explosives and blasting agents.
3. \$150 per year to sell explosives and blasting agents.
4. \$200 per year to manufacture explosives, blasting agents and fireworks.
5. \$350 the first day of fireworks, pyrotechnics or proximate audience displays conducted in any state-owned building and \$150 per day for each consecutive day for identical multi-day events. If an application is received by the State Fire Marshal's office less than 15 days prior to the planned event, the permit fee shall be ~~\$450 per~~ \$550 the first day and \$150 per day for each consecutive day for identical multi-day events. If an application is received by the State Fire Marshal's office less than seven days prior to the planned event, the permit fee shall be ~~\$550 per~~ \$650 the first day and \$150 per day for each consecutive day for identical multi-day events.
6. \$250 the first day of fireworks, pyrotechnics or proximate audience displays conducted out-of-doors on any state-owned property and \$150 per day for each consecutive day for identical multi-day events. If an application is received by the State Fire Marshal's office less than 15 days prior to the planned event, the permit fee shall be ~~\$450 per~~ \$550 the first day and \$150 per day for each consecutive day for identical multi-day events. If an application is received by the State Fire Marshal's office less than seven days prior to the planned event, the permit fee shall be ~~\$550 per~~ \$650 the first day and \$150 per day for each consecutive day for identical multi-day events.
7. \$100 per event for the use of explosives in special operations or emergency conditions.
8. \$300 the first day for flame effects conducted in accordance with Section 308.3.6 indoors of any state-owned building or outdoors on state-owned property and \$150 per day for each consecutive day for identical multi-day events, or, if conducted as part of a firework (pyrotechnic) display, \$100 the first day and \$75 per day for each consecutive day for identical multi-day events. If an application for flame effects is received by the State Fire Marshal's office less than 15 days prior to the planned event, the permit fee shall be ~~\$450 per~~ \$550 the first day and \$150 per day for each consecutive day for identical multi-day events or, if conducted as part of a firework (pyrotechnic) display, \$200 the first day and \$100 per day

for each consecutive day for identical multi-day events. If an application is received by the State Fire Marshal's office less than seven days prior to the planned event, the permit fee shall be ~~\$550 per~~ \$650 the first day and \$150 per day for each consecutive day for identical multi-day events or, if conducted as part of a firework (pyrotechnic) display, \$300 the first day and \$125 per day for each consecutive day for identical multi-day events.

~~P.~~ O. 107.14 State annual inspection permit fees. Annual fees for inspection permits issued by the State Fire Marshal's office for the inspection of buildings shall be as follows:

1. Nightclubs.
 - 1.1. \$350 for occupant load of 100 or less.
 - 1.2. \$450 for occupant load of 101 to 200.
 - 1.3. \$500 for occupant load of 201 to 300.
 - 1.4. \$500 plus \$50 for each 100 occupants where occupant loads exceed 300.
2. Private college dormitories with or without assembly areas. If containing assembly areas, such assembly areas are not included in the computation of square footage.
 - 2.1. \$150 for 3500 square feet or less.
 - 2.2. \$200 for greater than 3500 square feet up to 7000 square feet.
 - 2.3. \$250 for greater than 7000 square feet up to 10,000 square feet.
 - 2.4. \$250 plus \$50 for each additional 3000 square feet where square footage exceeds 10,000.
3. Assembly areas that are part of private college dormitories.
 - 3.1. \$50 for 10,000 square feet or less provided the assembly area is within or attached to a dormitory building.
 - 3.2. \$100 for greater than 10,000 square feet up to 25,000 square feet provided the assembly area is within or attached to a dormitory building, such as gymnasiums, auditoriums or cafeterias.
 - 3.3. \$100 for up to 25,000 square feet provided the assembly area is in a separate or separate buildings such as gymnasiums, auditoriums or cafeterias.
 - 3.4. \$150 for greater than 25,000 square feet for assembly areas within or attached to a dormitory building or in a separate or separate buildings such as gymnasiums, auditoriums or cafeterias.
4. Hospitals.
 - 4.1. \$300 for 1 to 50 beds.
 - 4.2. \$400 for 51 to 100 beds.
 - 4.3. \$500 for 101 to 150 beds.
 - 4.4. \$600 for 151 to 200 beds.
 - 4.5. \$600 plus \$100 for each additional 100 beds where the number of beds exceeds 200.

Regulations

5. Child day centers, assisted living facilities and adult day care centers licensed by the Virginia Department of Social Services based on licensed capacity as follows:

- 5.1. \$50 for 1 to 8.
- 5.2. \$75 for 9 to 20.
- 5.3. \$100 for 21 to 50.
- 5.4. \$200 for 51 to 100.
- 5.5. \$400 for 101 or more.

Exception: Annual inspection permits for any building or groups of buildings on the same site may not exceed \$2500.

~~Q. P.~~ 107.15. Fee schedule: The local governing body may establish a fee schedule. The schedule shall incorporate unit rates, which may be based on square footage, cubic footage, estimated cost of inspection or other appropriate criteria.

~~R. Q.~~ 107.16. Payment of fees: A permit shall not be issued until the designated fees have been paid.

Exception: The fire official may authorize delayed payment of fees.

13VAC5-51-85. Section 108.0. Operational permits.

A. 108.1. General. Operational permits shall be in accordance with Section 108. The fire official may require notification prior to (i) activities involving the handling, storage or use of substances, materials or devices regulated by the SFPC; (ii) conducting processes which produce conditions hazardous to life or property; or (iii) establishing a place of assembly.

B. 108.1.1. Permits required. Operational permits may be required by the fire official in accordance with Table 107.2. The fire official shall require operational permits for the manufacturing, storage, handling, use and sale of explosives. Issued permits shall be kept on the premises designated therein at all times and shall be readily available for inspection by the fire official.

Exceptions:

1. Operational permits will not be required by the State Fire Marshal except for the manufacturing, storage, handling, use and sale of explosives in localities not enforcing the SFPC.
2. Operational permits will not be required for the manufacturing, storage, handling or use of explosives or blasting agents by the Virginia Department of State Police provided notification to the fire official is made annually by the Chief Arson Investigator listing all storage locations.

C. 108.1.2. Duration of operational permits.

An operational permit allows the applicant to conduct an operation or a business for which a permit is required by Section 108.1.1 for either:

1. A prescribed period.
2. Until renewed, suspended, or revoked.

D. 108.1.3. Operational permits for the same location. When more than one operational permit is required for the same location, the fire official is authorized to consolidate such permits into a single permit provided that each provision is listed in the permit.

E. 108.2. Application. Application for an operational permit required by this code shall be made to the fire official in such form and detail as prescribed by the fire official. Applications for permits shall be accompanied by such plans as prescribed by the fire official.

F. 108.2.1. Refusal to issue permit. If the application for an operational permit describes a use that does not conform to the requirements of this code and other pertinent laws and ordinances, the fire official shall not issue a permit, but shall return the application to the applicant with the refusal to issue such permit. Such refusal shall, when requested, be in writing and shall contain the reasons for refusal.

G. 108.2.2. Inspection authorized. Before a new operational permit is approved, the fire official is authorized to inspect the receptacles, vehicles, buildings, devices, premises, storage spaces or areas to be used to determine compliance with this code or any operational constraints required.

H. 108.2.3. Time limitation of application. An application for an operational permit for any proposed work or operation shall be deemed to have been abandoned six months after the date of filing, unless such application has been diligently prosecuted or a permit shall have been issued; except that the fire official is authorized to grant one or more extensions of time for additional periods not exceeding 90 days each if there is reasonable cause.

I. 108.2.4. Action on application. The fire official shall examine or cause to be examined applications for operational permits and amendments thereto within a reasonable time after filing. If the application does not conform to the requirements of pertinent laws, the fire official shall reject such application in writing, stating the reasons. If the fire official is satisfied that the proposed work or operation conforms to the requirements of this code and laws and ordinances applicable thereto, the fire official shall issue a permit as soon as practicable.

J. 108.3. Conditions of a permit. An operational permit shall constitute permission to maintain, store or handle materials; or to conduct processes in accordance with the SFPC, and shall not be construed as authority to omit or amend any of the provisions of this code. ~~The building official shall issue permits to install equipment utilized in connection with such activities; or to install or modify any fire protection system or equipment or any other construction, equipment installation or modification in accordance with the provisions of this code where a permit is required by section 108.5. Such permission shall not be construed as authority to omit or amend any of the provisions of this code.~~

K. 108.3.1. Expiration. An operational permit shall remain in effect until reissued, renewed, or revoked for such a period

of time as specified in the permit. Permits are not transferable and any change in occupancy, operation, tenancy or ownership shall require that a new permit be issued.

L. 108.3.2. Extensions. A permittee holding an unexpired permit shall have the right to apply for an extension of the time within which the permittee will commence work under that permit when work is unable to be commenced within the time required by this section for good and satisfactory reasons. The fire official is authorized to grant, in writing, one or more extensions of the time period of a permit for periods of not more than 90 days each. Such extensions shall be requested by the permit holder in writing and justifiable cause demonstrated.

M. 108.3.3. Annual. The enforcing agency may issue annual operational permits for the manufacturing, storage, handling, use, or sales of explosives to any state regulated public utility.

N. 108.3.4. Suspension of permit. An operational permit shall become invalid if the authorized activity is not commenced within six months after issuance of the permit, or if the authorized activity is suspended or abandoned for a period of six months after the time of commencement.

O. 108.3.5. Posting. Issued operational permits shall be kept on the premises designated therein at all times and shall be readily available for inspection by the fire official.

P. 108.3.6. Compliance with code. The issuance or granting of an operational permit shall not be construed to be a permit for, or an approval of, any violation of any of the provisions of this code or of any other ordinance of the jurisdiction. Operational permits presuming to give authority to violate or cancel the provisions of this code or other ordinances of the jurisdiction shall not be valid. The issuance of a permit based on other data shall not prevent the fire official from requiring the correction of errors in the provided documents and other data. Any addition to or alteration of approved provided documents shall be approved in advance by the fire official, as evidenced by the issuance of a new or amended permit.

Q. 108.3.7. Information on the permit. The fire official shall issue all operational permits required by this code on an approved form furnished for that purpose. The operational permit shall contain a general description of the operation or occupancy and its location and any other information required by the fire official. Issued permits shall bear the original or electronic signature of the fire official or other designee approved by the fire official.

R. 108.4. Revocation. The fire official is authorized to revoke an operational permit issued under the provisions of this code when it is found by inspection or otherwise that there has been a false statement or misrepresentation as to the material facts in the application or documents on which the permit or approval was based including, but not limited to, any one of the following:

1. The permit is used for a location or establishment other than that for which it was issued.

2. The permit is used for a condition or activity other than that listed in the permit.

3. Conditions and limitations set forth in the permit have been violated.

4. Inclusion of any false statements or misrepresentations as to a material fact in the application for permit or plans submitted or a condition of the permit.

5. The permit is used by a different person or firm than the person or firm for which it was issued.

6. The permittee failed, refused or neglected to comply with orders or notices duly served in accordance with the provisions of this code within the time provided therein.

7. The permit was issued in error or in violation of an ordinance, regulation or this code.

13VAC5-51-91. Section 109.0. Inspection.

A. 109.1. Inspection: The fire official may inspect all structures and premises for the purposes of ascertaining and causing to be corrected any conditions liable to cause fire, contribute to the spread of fire, interfere with firefighting operations, endanger life, or any violations of the provisions or intent of the SFPC.

Exception: Single family dwellings and dwelling units in two family and multiple family dwellings and farm structures shall be exempt from routine inspections. This exemption shall not preclude the fire official from conducting routine inspections in Group R-3 or Group R-5 occupancies operating as a commercial bed and breakfast as outlined in Section ~~310.1~~ 310.3 of the USBC or inspecting under § 27-98.2 of the Code of Virginia for hazardous conditions relating to explosives, flammable and combustible conditions, and hazardous materials.

B. 109.1.1. Right to entry: The fire official may enter any structure or premises at any reasonable time to inspect subject to constitutional restrictions on unreasonable searches and seizures. If entry is refused or not obtained, the fire official may pursue recourse as provided by law.

Note: Specific authorization and procedures for inspections and issuing warrants are set out in §§ 27-98.1 through 27-98.5 of the Code of Virginia and shall be taken into consideration.

C. 109.1.2. Credentials: The fire official and technical assistants shall carry proper credentials of office when inspecting in the performance of their duties under the SFPC.

D. 109.2. Coordinated inspections: The fire official shall coordinate inspections and administrative orders with any other state and local agencies having related inspection authority, and shall coordinate those inspections required by the USBC for new construction when involving provisions of the amended IFC, so that the owners and occupants will not be subjected to numerous inspections or conflicting orders.

Note: The USBC requires the building official to coordinate such inspections with the fire official.

Regulations

E. ~~109.3~~. Other inspections: In accordance with ~~§ 36-139.3~~ 9.1-207 of the Code of Virginia, the State Fire Marshal, upon presenting proper credentials, shall make annual inspections for hazards incident to fire in all (i) residential care facilities operated by any state agency, (ii) assisted living facilities licensed or subject to licensure pursuant to Chapter 18 (§ 63.2-1800 et seq.) of Title 63.2 of the Code of Virginia which are not inspected by a local fire marshal, (iii) student-residence facilities owned or operated by the public institutions of higher education in the Commonwealth, and (iv) public schools in the Commonwealth which are not inspected by a local fire marshal. In the event that any such facility or residence is found to be nonconforming to the SFPC, the State Fire Marshal or local fire marshal may petition any court of competent jurisdiction for the issuance of an injunction.

13VAC5-51-111. Section 111.0. Violations.

A. 111.1. Notice: When the fire official discovers an alleged violation of a provision of the SFPC or other codes or ordinances under the fire official's jurisdiction, the fire official shall prepare a written notice citing the section allegedly violated, describing the condition deemed unsafe and specifying time limitations for the required abatements to be made to render the structure or premises safe and secure.

B. 111.1.1. Right of appeal. Notices of violation issued under Section 111.1 shall indicate the right of appeal by referencing the appeals section of this code.

Exceptions:

1. Summons issued in lieu of a notice of violation in accordance with Section 111.5 of this code.

2. Documents reflecting uncorrected violations in subsequent inspections to verify compliance.

~~B. C.~~ 111.2. Service: The written notice of violation of this code shall be served upon the owner, a duly authorized agent or upon the occupant or other person responsible for the conditions under violation. Such notice shall be served either by delivering a copy of same to such persons by mail to the last known post office address, by delivering in person or by delivering it to and leaving it in the possession of any person in charge of the premises, or, in the case such person is not found upon the premises, by affixing a copy thereof in a conspicuous place at the entrance door or avenue of access. Such procedure shall be deemed the equivalent of personal notice.

~~C. D.~~ 111.3. Failure to correct violations: If the notice of violation is not complied with within the time specified, the fire official shall request the legal counsel of the local governing body to institute the appropriate legal proceedings to restrain, correct, or abate such alleged violation.

~~D. E.~~ 111.4. Penalty: Penalties upon conviction of violating the SFPC shall be as set out in § 27-100 of the Code of Virginia.

~~E. F.~~ 111.5. Summons: When authorized and certified in accordance with § 27-34.2 of the Code of Virginia, the fire official may, subject to any limitations imposed by the local governing body, issue a summons in lieu of a notice of violation. Fire officials not certified in accordance with § 27-34.2 of the Code of Virginia may request the law-enforcement agency of the local governing body to make arrests for any alleged violations of the SFPC or orders affecting the immediate public safety.

13VAC5-51-121. Section 112.0. Appeals.

A. 112.1. Local Board of Fire Prevention Code Appeals (BFPCA): Each local governing body which enforces the SFPC shall have a BFPCA to hear appeals as authorized herein or it shall enter into an agreement with the governing body of another county or municipality, with some other agency, or with a state agency approved by the DHCD to act on appeals. An appeal case decided by some other approved agency shall constitute an appeal in accordance with this section and shall be final unless appealed to the State Building Code Technical Review Board (TRB).

B. 112.2. Membership: The BFPCA shall consist of at least five members appointed by the local governing body and having terms of office established by written policy. Alternate members may be appointed to serve in the absence of any regular members and as such, shall have the full power and authority of the regular members. Regular and alternate members may be reappointed. Written records of current membership, including a record of the current chairman and secretary shall be maintained in the office of the local governing body. In order to provide continuity, the terms of the members may be of different length so that less than half will expire in any one-year period. The BFPCA shall meet at least once annually to assure a duly constituted board, appoint officers as necessary and receive such training on the code as may be appropriate or necessary from staff of the locality.

C. 112.2.1. Chairman: The BFPCA shall annually select one of its regular members to serve as chairman. In case of the absence of the chairman at a hearing, the members present shall select an acting chairman.

D. 112.2.2. Secretary: The local governing body shall appoint a secretary to the BFPCA to maintain a detailed record of all proceedings.

E. 112.3. Qualifications of members: BFPCA members shall be selected by the local governing body on the basis of their ability to render fair and competent decisions regarding application of the SFPC and shall, to the extent possible, represent different occupational or professional fields relating to building construction or fire prevention. At least one member should be an experienced builder and one member a licensed professional engineer or architect. Employees or officials of the local governing body shall not serve as members of the BFPCA.

F. 112.4. Disqualification of member: A member shall not hear an appeal in which that member has conflict of interest

in accordance with the State and Local Government Conflict of Interests Act, Chapter 31 (§ 2.2-3100 et seq.) of Title 2.2 of the Code of Virginia.

G. 112.5. Application for appeal: The owner of a structure, the owner's agent or any other person involved in the design, construction or maintenance of the structure may appeal a decision of the fire official concerning the application of the SFPC or the fire official's refusal to grant modification under Section 106.5 to the provisions of the SFPC. The appeal shall first lie to the local board of fire prevention code appeals (BFPCA) and then to the TRB except that appeals concerning the application of the SFPC or refusal to grant modifications by the State Fire Marshal shall be made directly to the TRB. The appeal shall be submitted to the BFPCA within 14 calendar days of the application of the SFPC. The application shall contain the name and address of the owner of the structure and the person appealing if not the owner. A copy of the written decision of the fire official shall be submitted along with the application for appeal and maintained as part of the record. The application shall be stamped or otherwise marked by the BFPCA to indicate the date received. Failure to submit an application for appeal within the time limit established by this section shall constitute acceptance of the fire official's decision.

Note: In accordance with § 27-98 of the Code of Virginia, any local fire code may provide for an appeal to a local board of appeals. If no local board of appeals exists, the TRB shall hear appeals of any local fire code violation.

H. 112.6. Notice of meeting: The BFPCA shall meet within 30 calendar days after the date of receipt of the application for appeal. Notice indicating the time and place of the hearing shall be sent to the parties in writing to the addresses listed on the application at least 14 calendar days prior to the date of the hearing. Less notice may be given if agreed upon by the applicant.

I. 112.7. Hearing procedures: All hearings before the BFPCA shall be open to the public. The appellant, the appellant's representative, the local governing body's representative and any person whose interests are affected shall be given an opportunity to be heard. The chairman shall have the power and duty to direct the hearing, rule upon the acceptance of evidence and oversee the record of all proceedings.

J. 112.7.1. Postponement: When a quorum of the BFPCA is not present to hear an appeal, either the appellant or the appellant's representative shall have the right to request a postponement of the hearing. The BFPCA shall reschedule the appeal within 30 calendar days of the postponement.

K. 112.8. Decision: The BFPCA shall have the power to uphold, reverse or modify the decision of the fire official by a concurring vote of a majority of those present. Decisions of the BFPCA shall be final if no appeal is made therefrom and the appellant and the fire official shall act accordingly.

L. 112.8.1. Resolution: The ~~BFPCA's~~ BFPCA's decision shall be by resolution signed by the chairman and retained as part of the record by the BFPCA. The following wording shall be part of the resolution: "Any person who was a party to the appeal may appeal to the State Building Code Technical Review Board (TRB) by submitting an application to the TRB within 21 calendar days upon receipt by certified mail of this resolution. Application forms are available from the Office of the TRB, ~~501 North Second~~ 600 East Main Street, Richmond, Virginia 23219, (804) 371-7150." Copies of the resolution shall be furnished to all parties.

M. 112.9. Appeal to the TRB: After final determination by the BFPCA, any person who was a party to the local appeal may appeal to the TRB. Application shall be made to the TRB within 21 calendar days of receipt of the decision to be appealed. Application for appeal to the TRB arising from the SFMO's enforcement of the code or from any local fire code violation if no local board of appeals exists shall be made to the TRB within 14 calendar days of receipt of the decision to be appealed and shall be accompanied by copies of the inspection reports and other relevant information. Failure to submit an application for appeal within the time limit established by this section shall constitute an acceptance of the BFPCA's resolution or fire official's decision.

N. 112.9.1. Information to be submitted: Copies of the fire official's decision and the resolution of the BFPCA shall be submitted with the application for appeal. Upon request by the office of the TRB, the BFPCA shall submit a copy of all inspection reports and all pertinent information from the record of the BFPCA.

O. 112.9.2. Decision of TRB: Procedures of the TRB are in accordance with Article 2 (§ 36-108 et seq.) of Chapter 6 of Title 36 of the Code of Virginia. Decisions of the TRB shall be final if no appeal is made therefrom and the appellant and the code official shall act accordingly.

13VAC5-51-130. IFC Section 202.0. Definitions.

A. Add the following definitions:

~~Background clearance card: See Section 3302.4 or BCC:~~ An identification card issued to an individual who is not a certified blaster or pyrotechnician and is responsible management or an employee of a company, corporation, firm, or other entity, solely for the purpose of submitting an application to the fire official for a permit to manufacture, use, handle, store, or sell explosive materials; or conduct a fireworks display. A person to whom a BCC has been issued can fulfill the role of a designated individual on an application for a permit to manufacture, use, handle, store, or sell explosive materials; or on an application for a permit to design, setup, and conduct a fireworks display.

~~Blaster, restricted: See Section 3302.4~~ Any person engaging in the use of explosives or blasting agents utilizing five pounds (2.25 kg) or less per blasting operation and using instantaneous detonators. A certified

Regulations

restricted blaster can fulfill the role of a designated individual on an application for permit to manufacture, use, handle, store, or sell explosive materials.

Blaster, unrestricted: See Section 3302.1 Any person engaging in the use of explosives or blasting agents without the limit to the amount of explosives or blasting agents or type of detonator. A certified unrestricted blaster can fulfill the role of a designated individual on an application for permit to manufacture, use, handle, store, or sell explosive materials.

Design: For the purposes of a fireworks display, either inside a building or structure or outdoors, it shall mean the pyrotechnician who will be in attendance and makes the final artistic determination for the placement of fireworks and ground display pieces suitable for the display site.

Designated individual: See Section 3302.1 A person who is in possession of a BCC issued by the SFMO, certified by the SFMO as a pyrotechnician, or a restricted or unrestricted blaster, any of whom are responsible for ensuring compliance with state law and regulations relating to blasting agents and explosives and applying for explosives or firework permits; is at least 21 years of age; and demonstrates the capability to effectively communicate safety messages verbally and in writing in the English language.

DHCD: The Virginia Department of Housing and Community Development.

Local government, local governing body or locality: The governing body of any county, city, or town, other political subdivision and state agency in this Commonwealth charged with the enforcement of the SFPC under state law.

Night club: Any building or portion thereof in which the main use is a place of public assembly that provides exhibition, performance or other forms or entertainment; serves alcoholic beverages; and provides music and space for dancing.

Permissible fireworks: Any sparklers, fountains, Pharaoh's serpents, caps for pistols, or pinwheels commonly known as whirligigs or spinning jennies.

Pyrotechnician (firework operator): See Section 3302.1 Any person supervising or engaged in the design, setup, or conducting of any fireworks display, either inside a building or outdoors. A certified pyrotechnician can fulfill the role of a designated individual on an application for a permit for a fireworks display.

Pyrotechnician, aerial: A person supervising or engaged in the design, setup, or conducting of an outdoor aerial fireworks display performed in accordance with the regulations as set forth in this code and NFPA 1123, a referenced standard for fireworks displays.

Pyrotechnician, proximate: A person supervising or engaged in the design, setup, or conducting of a fireworks display, either inside a building or outdoors, performed in

accordance with the regulations as set forth in this code and NFPA 1126, a referenced standard for the use of pyrotechnics before a proximate audience.

Responsible management--See Section 3302.1: A person who is any of the following:

1. The sole proprietor of a sole proprietorship.
2. The partners of a general partnership.
3. The managing partners of a limited partnership.
4. The officers of a corporation.
5. The managers of a limited liability company.
6. The officers or directors of an association, or both.
7. Individuals in other business entities recognized under the laws of the Commonwealth as having a fiduciary responsibility to the firm.

Sole proprietor--See Section 3302.1: A person or individual, not a corporation, who is trading under his own name or under an assumed or fictitious name pursuant to the provisions of §§ 59.1-69 through 59.1-76 of the Code of Virginia.

State Fire Marshal: The State Fire Marshal as provided for by § 36-139.2 9.1-206 of the Code of Virginia.

State Regulated Care Facility (SRCF): A building with an occupancy in Group R-2, R-3, R-4, or R-5 occupied by persons in the care of others where program oversight is provided by the Virginia Department of Social Services, the Virginia Department of Behavioral Health and Developmental Services, the Virginia Department of Education or the Virginia Department of Juvenile Justice.

Technical Assistant: Any person employed by or under an extended contract to a local enforcing agency for enforcing the SFPC. For the purposes of this definition, an extended contract shall be a contract with an aggregate term of 18 months or longer.

TRB: The Virginia State Building Code Technical Review Board.

USBC: The Virginia Uniform Statewide Building Code (13VAC5-63).

B. Add the following definition under the term "Occupancy Classification--Residential Group R":

R-5 Detached one and two-family dwellings and multiple single-family dwellings (townhouses) not more than three stories high with separate means of egress and their accessory structures. The terms "R-5" and "one and two-family dwelling" where used in this code shall be interchangeable.

C. Change the following definition definitions to read:

Automatic fire-extinguishing system: An approved system of devices and equipment that automatically detects a fire and discharges an approved fire-extinguishing agent onto or in the area of a fire. Such system shall include an

automatic sprinkler system, unless otherwise expressly stated.

Fire code official: The officer or other designated authority charged with administration and enforcement of this code, or a duly authorized representative. For the purpose of this code, the terms "code official" and "fire official" shall have the same meaning as the term "fire code official" and, in addition, such official shall have the powers outlined in § 27-98.1 of the Code of Virginia.

Fireworks: Any firecracker, torpedo, skyrocket, or other substance or object, of whatever form or construction, that contains any explosive or inflammable compound or substance, and is intended, or commonly known, as fireworks and that explodes, rises into the air or travels laterally, or fires projectiles into the air. Fireworks shall not include automobile flares, paper caps containing not more than the average of 0.25 grain (16 mg) of explosive content per cap or toy pistols, toy canes, toy guns, or other devices utilizing such caps and items commonly known as party poppers, pop rocks, and snap-n-pops. Fireworks may be further delineated and referred to as:

Fireworks, 1.4G (formerly known as Class C, Common Fireworks): Small fireworks devices containing restricted amounts of pyrotechnic composition designed primarily to produce visible or audible effects by combustion. Such 1.4G fireworks that comply with the construction, chemical composition, and labeling regulations of the DOTn for Fireworks, UN0336, and the U.S. Consumer Product Safety Commission as set forth in CPSC 16 CFR Parts 1500 and 1507, are not explosive materials for the purpose of this code.

Fireworks, 1.3G (formerly Class B, Special Fireworks): Large fireworks devices, which are explosive materials, intended for the use in fireworks displays and designed to produce audible or visible effects by combustion, deflagration, or detonation. Such 1.3G fireworks include, but are not limited to, firecrackers containing more than 130 milligrams (2 grains) of explosive composition, aerial shells containing more than 40 grams of pyrotechnic composition, and other display pieces that exceed the limits for classification as 1.4G fireworks. Such 1.3G fireworks are also described as Fireworks, UN0335 by the DOTn.

Smokeless propellants. Solid propellants, commonly referred to as smokeless powders or any propellant classified by DOTn as a smokeless propellant in accordance with NA3178, Smokeless Powder for Small Arms, used in small arms ammunition, firearms, cannons, rockets, propellant-actuated devices, and similar articles.

13VAC5-51-131. IFC Chapter 3. Precautions Against Fire General Requirements.

A. Add Section 301.3 to read:

301.3. Occupancy. The occupancy of a structure shall be continued as originally permitted under and in full compliance with the codes in force at the time of construction or alteration. The occupancy of a structure shall not change to another occupancy that will subject the structure to any special provisions of this code or the USBC without the approval of the building official.

B. Change Section 304.3.2 to read:

304.3.2. Capacity exceeding 5.88 cubic feet. Containers with a capacity exceeding 5.88 cubic feet (44 gallons) (0.17 m³) shall be provided with lids. Containers and lids shall be constructed of noncombustible materials or approved combustible materials.

C. Add Section 311.5.6 to read:

311.5.6. Removal. Removal of placards posted in accordance with this section without the approval of the fire official shall be a violation of this code.

D. Change Section 314.1 to read:

314.1. General. Indoor displays constructed within any building or structure shall comply with Sections 314.2 through 314.5.

E. Add Section 314.5 to read:

314.5. Smokeless powder and small arms primers. Venders shall not store, display, or sell smokeless powder or small arms primers during trade shows inside exhibition halls except as follows:

1. The amount of smokeless powder displayed by each vender is limited to the amount established in Section 5506.5.1.1.

2. The amount of smokeless powder each vender may store is limited to the storage arrangements and storage amounts established in Section 5506.5.2.1. Smokeless powder shall remain in the manufacturer's original sealed container, and the container shall remain sealed while inside the building. The repackaging of smokeless powder shall not be performed inside the building. Damaged containers shall not be repackaged inside the building and shall be immediately removed from the building in such manner to avoid spilling any powder.

3. There shall be at least 50 feet separation between venders and 20 feet from any exit.

4. Small arms primers shall be displayed and stored in the manufacturer's original packaging and in accordance with the requirements of Section 5506.5.2.3.

F. Change Section 315.4 to read:

315.4. Outside storage. Outside storage of combustible materials shall not be located within 10 feet (3048 mm) of a property line or other building on the site.

Regulations

Exceptions:

1. The separation distance is allowed to be reduced to 3 feet (914 mm) for storage not exceeding 6 feet (1829 mm) in height.
2. The separation distance is allowed to be reduced when the fire official determines that no hazard to the adjoining property exists.

G. Change Section 315.4.1 to read:

315.4.1. Storage beneath overhead projections from buildings. To the extent required by the code the building was constructed under, when buildings are required to be protected by automatic sprinklers, the outdoor storage, display, and handling of combustible materials under eaves, canopies, or other projections or overhangs is prohibited except where automatic sprinklers are installed under such eaves, canopies, or other projections or overhangs.

13VAC5-51-132. IFC Chapter 4. Emergency Planning and Preparedness.

A. Add Section 401.1.1 to read:

401.1.1. State Regulated Care Facilities: ~~when.~~ When a state license is required by the Virginia Department of Social Services; Virginia Department of Behavioral Health and Developmental Services; Virginia Department of Education; or Virginia Department of Juvenile Justice to operate, SRCF shall comply with this section and the provisions of Section 404.0.

B. Add item ~~15~~ 16 to Section 404.2 to read:

~~15.~~ 16. SRCF.

C. Add exception to Section 405.1 to read:

Exception: Emergency evacuation drills shall not be conducted in school buildings during periods of mandatory testing required by the Virginia Board of Education.

D. ~~Add~~ Delete the "High-rise buildings" category, and add the following category to Table 405.2 to read:

Group or occupancy	Frequency	Participation
SRCF	Monthly	All occupants

E. Add Section 405.2.1 to read:

405.2.1. High-rise buildings. Fire exit drills shall be conducted annually by building staff personnel or the owner of the building in accordance with the fire safety plan and shall not affect other current occupants.

F. Add Section 408.1.1 to read:

408.1.1. Maintaining occupant load posting. Occupant load postings required by the building code are required to be maintained.

G. Change Section 408.2 to read:

408.2. Group A occupancies. Group A occupancies shall comply with applicable requirements of Sections 408.2.1 through 408.2.3 and 401 through 406.

H. Add Sections 408.2.3, 408.2.3.1 and 408.2.3.2 to read:

408.2.3. Night clubs. Night clubs shall comply with Sections 408.2.3.1 and 408.2.3.2.

408.2.3.1. Audible announcements. Audible announcements shall be made to the occupants no longer than 10 minutes prior to the start of the entertainment and at each intermission to notify the occupants of the location of the exits to be used in the event of a fire or other emergency.

408.2.3.2. Occupant load count. Upon request of the fire code official, the owner or operator, or both, will be required to keep a running count of the occupant load to provide to the fire code official during performance hours of operation, entertainment hours of operation, or both.

13VAC5-51-133. IFC Chapter 5. Fire Service Features.

A. Delete Section 501.4.

B. Add exceptions to Section 503.1 to read:

Exceptions:

1. Fire apparatus access roads shall be permitted to be provided and maintained in accordance with written policy that establish fire apparatus access road requirements and such requirements shall be identified to the owner or his agent prior to the building official's approval of the building permit.

2. On construction and demolition sites fire apparatus access roads shall be permitted to be provided and maintained in accordance with Section ~~440.1~~ 3310.1.

C. Add exception to Section 503.2.1 to read:

Exception: Fire apparatus access roads exclusively serving single family dwelling or townhouse developments that are fully sprinklered as provided for in Sections R313.1 or R313.2 of the International Residential Code shall have an unobstructed width of not less than 18 feet (5486 mm), exclusive of shoulders.

D. Add Section 503.7 to read:

503.7. Fire lanes for existing buildings. The fire code official is authorized to designate public and private fire lanes as deemed necessary for the efficient and effective operation of fire apparatus. Fire lanes shall comply with Sections 503.2 through 503.6.

~~E. Change the title of Section 506 to read "Key Boxes and Elevator Fire Service Keys."~~

~~F. Change Section 506.1 to read:~~

~~506.1. Where required. Where access to or within a structure or an area is restricted because of secured openings or where immediate access is necessary for life-saving or firefighting purposes, the fire code official is authorized to require a key box to be installed in an~~

approved location. The key box shall be of an approved type listed in accordance with UL 1037 and shall contain keys to gain necessary access as required by the fire code official.

Exception: Existing key boxes are not required to be listed in accordance with UL 1037 unless replaced.

G. Add Section 506.3, including all subsections, to read:

~~506.3. Standardized fire service elevator keys. All buildings with elevators equipped with Phase I emergency recall or Phase II emergency in-car operation, or buildings equipped with fire service access or occupant evacuation elevators shall be equipped to operate with a standardized fire service key approved by the fire code official.~~

~~Exception: Where providing a standardized key is not possible due to the existing nonstandard elevator equipment, the owner shall be permitted to place the building's nonstandardized fire service elevator keys in a key box installed in accordance with Section 506.1.~~

~~506.3.1. Requirements for standardized fire service keys. Standardized fire service elevator keys shall comply with all of the following:~~

- ~~1. All fire service elevator keys within the jurisdiction shall be uniform and specific for the jurisdiction. Keys shall be cut to a uniform key code.~~
- ~~2. Fire service elevator keys shall be a patent protected design to prevent unauthorized duplication.~~
- ~~3. Fire service elevator keys subject to these rules shall be engraved with the words "DO NOT DUPLICATE."~~

~~506.3.2. Access to standardized fire service keys. Access to standardized fire service elevator keys shall be restricted to the following persons or groups:~~

- ~~1. Elevator owners or their authorized agents.~~
- ~~2. Elevator contractors.~~
- ~~3. Elevator inspectors of the jurisdiction.~~
- ~~4. Fire and building code officials of the jurisdiction.~~
- ~~5. The fire department and other emergency response agencies designated by the fire code official and the code official responsible for the enforcement of Part III, Maintenance, of the USBC.~~

~~506.3.3. Duplication or distribution of keys. No person may duplicate a standardized fire service elevator key or issue, give, or sell a duplicated key unless in accordance with this code.~~

~~506.3.4. Responsibility to provide keys. The building owner shall provide up to three standardized fire service elevator keys, if required by the fire code official, upon installation of a standardized fire service key switch or switches in the building.~~

H. E. Add Sections 507.3.1 and 507.3.2 to read:

507.3.1. Fire flow requirements for fully sprinklered residential developments. Notwithstanding Section

103.1.2, the fire flow requirements in Table B105.1 of Appendix B of the IFC, as modified by Section 507.3.2, shall be permitted to be used for determining fire flow in single family dwelling and townhouse developments which are fully sprinklered as provided for in Sections R313.1 or R313.2 of the International Residential Code.

507.3.2. Modifications to Table B105.1. The first six rows of columns five and six of Table B105.1 of Appendix B of the IFC shall be modified as shown below for the use of Table B105.1 in Section 507.3.1.

Type 5-B	Fire-flow (gallons per minute)
0-5000	1000
5001-7200	1250
7201-8200	1500
8201-9500	1750
9501-11300	2000
11301-13000	2250

I. F. Change Section 507.5.1 to read:

507.5.1. Where required, fire hydrant systems shall be located and installed as directed by the fire department. Fire hydrant systems shall conform to the written standards of the jurisdiction and the fire department.

J. G. Add Section ~~507.5.1.1~~ 507.5.1.2 to read:

~~507.5.1.1~~ 507.5.1.2. Fire hydrant requirements for fully sprinklered residential developments. Notwithstanding Section 103.1.2, the number and distribution of fire hydrants in Table C105.1 of Appendix C of the IFC shall be permitted to be used in single family dwelling and townhouse developments which are fully sprinklered as provided for in Sections R313.1 or R313.2 of the International Residential Code, with the spacing and distances of fire hydrants indicated in Table C105.1 increased by 100%.

K. H. Change Section 510 to read:

Section 510.
Maintenance of In-Building Emergency Communication
Equipment.

510.1. General. In-building emergency communication equipment shall be maintained in accordance with USBC and the provisions of this section.

510.2. Additional in-building emergency communications installations. If it is determined by the locality that increased amplification of their emergency communication system is needed, the building owner shall allow the locality access as well as provide appropriate space within the building to install and maintain necessary additional communication equipment by the locality. If the building owner denies the locality access or appropriate space, or

Regulations

both, the building owner shall be responsible for the installation and maintenance of these additional systems.

510.3. Field tests. After providing reasonable notice to the owner or their representative, the fire official, police chief, or their agents shall have the right during normal business hours, or other mutually agreed upon time, to enter onto the property to conduct field tests to verify that the required level of radio coverage is present at no cost to the owner.

13VAC5-51-133.5. IFC Chapter 6. Building Services and Systems.

A. Add a note to Section 603.7 to read:

Note: The fire code official may request a copy of the latest certificate of inspection from the Virginia Department of Labor and Industry for boilers and pressure vessels subject to such requirements. When the certificate is not available, the fire code official shall notify the Department of Labor and Industry to ensure that the required maintenance and testing is performed in accordance the Virginia Boiler and Pressure Vessel Regulations (16VAC25-50).

B. Add Section ~~604.6~~ 604.7 to read:

~~604.6~~ 604.7. Testing of Battery Powered Emergency Lights and Exit Signs. Required emergency lighting utilizing battery powered emergency lights or exit signs, or both, shall be tested annually. The emergency lights and exit signs shall be tested for proper operation for the time period established in the building code in effect when the equipment was installed. Written records of tests shall be retained by the owner of the building for a minimum of two years after the test is conducted and shall be made available to the fire code official upon request.

C. Change Section 605.10.1 to read:

605.10.1. Listed and labeled. Only portable electric space heaters listed and labeled in accordance with UL 1278 shall be used.

13VAC5-51-135. IFC Chapter 9. Fire Protection Systems.

A. Change Section 901.4.2 to read:

901.4.2. Nonrequired fire protection systems. Nonrequired fire protection systems shall be maintained to function as originally installed. If any such systems are to be reduced in function or discontinued, approval shall be obtained from the building official in accordance with Section 103.8.1 of Part I of the USBC.

B. Delete Section ~~901.4.3~~ 901.4.4.

C. Change Section 901.6 to read:

901.6. Inspection, testing and maintenance. To the extent that equipment, systems, devices, and safeguards, such as fire detection, alarm and extinguishing systems, which were provided and approved by the building official when constructed, shall be maintained in an operative condition at all times. And where such equipment, systems, devices,

and safeguards are found not to be in an operative condition, the fire official shall order all such equipment to be rendered safe in accordance with the USBC.

D. Add Section ~~901.10~~ 901.11 to read:

~~901.10~~ 901.11. Defective equipment. When the fire official determines through investigation or testing or reports by a nationally recognized testing agency that specific, required water sprinkler or water-spray extinguishing equipment has been identified as failing to perform or operate through not less than 30 randomly selected sprinkler heads at four or more building sites anywhere in the nation, the fire official shall order all such equipment to be rendered safe.

~~E. Change the following definition in Section 902 to read:~~

~~Automatic fire extinguishing system. An approved system of devices and equipment which automatically detects a fire and discharges an approved fire extinguishing agent onto or in the area of a fire. Such system shall include an automatic sprinkler system, unless otherwise expressly stated.~~

~~F. E.~~ Change ~~item~~ Item 1 in Section 906.1 to read:

1. In Group A, B, E, F, H, I, M, R-1, R-4 and S occupancies.

Exception ~~Exceptions~~:

1. In Groups A, B, and E occupancies equipped throughout with quick response sprinklers, portable fire extinguishers shall be required only in locations specified in Items 2 through 6.

2. In Group I-3 occupancies, portable fire extinguishers shall be permitted to be located at staff locations and the access to such extinguishers shall be permitted to be locked.

G. Add a note to Section 906.1 to read:

Note: In existing buildings, whether fire extinguishers are needed is determined by the USBC or other code in effect when such buildings were constructed.

H. Change Section ~~907.9.2~~ 907.8.2 to read:

~~907.9.2~~ 907.8.2. Testing. Testing shall be performed in accordance with the schedules in Chapter 10 of NFPA 72 or more frequently where required by the fire code official. Where automatic testing is performed at least weekly by a remotely monitored fire alarm control unit specifically listed for the application, the manual testing frequency shall be permitted to be extended to annual. In Group R-1 occupancies, battery-powered single station smoke detectors shall be tested and inspected at one-month intervals.

Exception: Devices or equipment that are inaccessible for safety considerations shall be tested during scheduled shutdowns where approved by the fire code official, but not less than every 18 months.

I. Change Section ~~907.9.5~~ 907.8.5 to read:

~~907.9.5~~ 907.8.5. Maintenance, inspection and testing. The building owner shall be responsible for maintaining the fire and life safety systems in an operable condition at all times. Service personnel shall meet the qualification requirements of NFPA 72 for maintaining, inspecting and testing such systems. A written record shall be maintained and shall be made available to the fire code official. In addition to all applicable information contained in Figure 10.6.2.3 of NFPA 72, the written record of inspections, testing and maintenance shall contain the following minimum information:

1. Date, name and address of property.
2. Name of person performing inspection, maintenance and tests, or combination thereof, and affiliation, business address and telephone number.
3. Name, address and representative of approving agency or agencies.
4. Test frequency.
5. Designation of the detector or detectors tested (for example, "Test performed in accordance with Section _____").
6. Physical location (for example, "Heat detector in main kitchen; horn-strobe in Room 115.") and a list of all initiating and notification devices and appliances tested.
7. Functional list of detectors and required sequence of operations.
8. Check of all smoke detectors.
9. Loop resistance for all fixed-temperature, line-type detectors.
10. Other tests as required by either the equipment manufacturer's published instructions or the authority having jurisdiction.
11. Signature of tester and approved authority representative.
12. Disposition of problems identified during test (examples, "Owner notified," "Problem corrected or successfully retested, or both," "Device abandoned in place.").

J. ~~Add~~ Change Section 908.7 to read:

908.7. Carbon monoxide alarms. Carbon monoxide alarms shall be maintained as approved.

K. Delete Section 908.7.1.

13VAC5-51-138. IFC Chapter 11. Construction Requirements for Existing Buildings.

Delete Chapter 11 in its entirety.

13VAC5-51-140. IFC Chapter 22 23. Service Stations Motor Fuel-Dispensing Facilities and Repair Garages.

A. Change Section ~~2205.4~~ 2305.4 to read:

~~2205.4~~ 2305.4. Sources of ignition. Smoking and open flames shall be prohibited within 20 feet (6096 mm) of a

fuel dispensing device. The engines of vehicles being fueled shall be shut off during fueling. Electrical equipment shall be in accordance with NFPA 70.

B. Change Section ~~2206.2.1.1~~ 2306.2.1.1 to read:

~~2206.2.1.1~~ 2306.2.1.1. Inventory control and leak detection for underground tanks. Accurate inventory records shall be maintained on underground fuel storage tanks for indication of possible leakage from tanks and piping. The records shall be kept at the premises or made available for inspection by the fire official within 24 hours of a written or verbal request and shall include records for each tank. Where there is more than one system consisting of tanks serving separate pumps or dispensers for a product, the inventory record shall be maintained separately for each tank system.

Owners and operators of underground fuel storage tanks shall provide release detection for tanks and piping that routinely contain flammable and combustible liquids in accordance with one of the following methods:

1. Monthly inventory control to detect a release of at least 1.0% of flow-through plus 130 gallons.
2. Manual tank gauging for tanks with 2,000 gallon capacity or less when measurements are taken at the beginning and ending of a ~~36-hour~~ to 58-hour period during which no liquid is added to or removed from the tank.
3. Tank tightness testing capable of detecting a 0.1 gallon per hour leak rate.
4. Automatic tank gauging that tests for loss of liquid.
5. Vapor monitoring for vapors within the soil of the tank field.
6. Groundwater monitoring when the groundwater is never more than 20 feet from the ground surface.
7. Interstitial monitoring between the underground tank and a secondary barrier immediately around or beneath the tank.
8. Other approved methods that have been demonstrated to be as effective in detecting a leak as the methods listed above.

A consistent or accidental loss of product shall be immediately reported to the fire official.

13VAC5-51-145. IFC Chapter 27 50. Hazardous Materials - General Provisions.

A. Add the following language to the end of Section ~~2701.5.1~~ 5001.5.1 to read:

The HMMP shall be maintained onsite for use by emergency responders, and shall be updated not less than annually.

B. Add the following language to the end of Section ~~2701.5.2~~ 5001.5.2 to read:

Regulations

The HMIS shall be maintained onsite or readily available through another means where approved by the fire code official for use by temporary responders, and shall be updated not less than annually.

C. Add Sections ~~2701.5.3~~, ~~2701.5.3.1~~ 5001.5.3, 5001.5.3.1, and ~~2701.5.3.2~~ 5001.5.3.2 to read:

~~2701.5.3~~ 5001.5.3. Repository container. When a HMMP or HMIS is required, the owner or operator shall provide a repository container (lock box) or other approved means for the storage of items required in Sections ~~2701.5.1~~ 5001.5.1 and ~~2701.5.2~~ 5001.5.2 so as to be readily available to emergency response personnel.

~~2701.5.3.1~~ 5001.5.3.1. Location and identification. The repository container (lock box) shall be located, installed and identified in an approved manner.

~~2701.5.3.2~~ 5001.5.3.2. Keying. All repository containers (lock boxes) shall be keyed as required by the fire code official.

D. Change Section ~~2703.3.1.4~~ 5003.3.1.4 to read:

~~2703.3.1.4~~ 5003.3.1.4. Responsibility for cleanup. The person, firm or corporation responsible for an unauthorized discharge shall institute and complete all actions necessary to remedy the effects of such unauthorized discharge, whether sudden or gradual, at no cost to the jurisdiction. The fire code official may require records and receipts to verify cleanup and proper disposal of unauthorized discharges. When deemed necessary by the fire code official, cleanup may be initiated by the fire department or by an authorized individual or firm. Costs associated with such cleanup shall be borne by the owner, operator or other person responsible for the unauthorized discharge.

13VAC5-51-150. IFC Chapter 33 56. Explosives and Fireworks.

A. Change exception 4 in Section ~~3301.1~~ 5601.1 to read:

4. The possession, storage, and use of not more than 15 pounds (6.81 kg) of commercially manufactured sporting black powder, 20 pounds (9 kg) of smokeless powder and any amount of small arms primers for hand loading of small arms ammunition for personal consumption.

B. Add exceptions 10, 11 and 12 to Section ~~3301.1~~ 5601.1 to read:

10. The storage, handling, or use of explosives or blasting agents pursuant to the provisions of Title 45.1 of the Code of Virginia.

11. The display of small arms primers in Group M when in the original manufacturer's packaging.

12. The possession, storage and use of not more than 50 pounds (23 kg) of commercially manufactured sporting black powder, 100 pounds (45 kg) of smokeless powder, and small arms primers for hand loading of small arms ammunition for personal consumption in Group R-3 or R-5, or 200 pounds (91 kg) of smokeless powder when stored

in the manufacturer's original containers in detached Group U structures at least 10 feet (3048 mm) from inhabited buildings and are accessory to Group R-3 or R-5.

C. Change exception 4 in Section ~~3301.1.3~~ 5601.1.3 to read:

4. The possession, storage, sale, handling and use of permissible fireworks where allowed by applicable local or state laws, ordinances and regulations provided such fireworks comply with CPSC 16 CFR, Parts 1500-1507, and DOTn 49 CFR, Parts 100-178, for consumer fireworks.

D. Add exception 5 to Section ~~3301.1.3~~ 5601.1.3 to read:

5. The sale or use of materials or equipment when such materials or equipment is used or to be used by any person for signaling or other emergency use in the operation of any boat, railroad train or other vehicle for the transportation of persons or property.

E. Change entire Section ~~3301.2~~ 5601.2 to read:

~~3301.2~~ 5601.2. Permit required. Permits shall be required as set forth in Section 107.2 and regulated in accordance with this section. The manufacture, storage, possession, sale and use of fireworks or explosives shall not take place without first applying for and obtaining a permit.

~~3301.2.1~~ 5601.2.1. Residential uses. No person shall keep or store, nor shall any permit be issued to keep, possess or store, any fireworks or explosives at any place of habitation, or within 100 feet (30,480 mm) thereof.

Exception: Storage of smokeless propellant, black powder, and small arms primers for personal use and not for resale in accordance with Section ~~3306~~ 5606.

~~3301.2.2~~ 5601.2.2. Sale and retail display. Except for the Armed Forces of the United States, Coast Guard, National Guard, federal, state and local regulatory, law enforcement and fire agencies acting in their official capacities, explosives shall not be sold, given, delivered or transferred to any person or company not in possession of a valid permit. The holder of a permit to sell explosives shall make a record of all transactions involving explosives in conformance with Section ~~3303.2~~ 5603.2 and include the signature of any receiver of the explosives. No person shall construct a retail display nor offer for sale explosives, explosive materials, or fireworks upon highways, sidewalks, public property, or in assembly or educational occupancies.

~~3301.2.3~~ 5601.2.3. Permit restrictions. The fire official is authorized to limit the quantity of explosives, explosive materials, or fireworks permitted at a given location. No person, possessing a permit for storage of explosives at any place, shall keep or store an amount greater than authorized in such permit. Only the kind of explosive specified in such a permit shall be kept or stored.

~~3301.2.3.1~~ 5601.2.3.1. Permit applicants. As a condition of a permit as provided for in Section 107.5, the fire official shall not issue a permit to manufacture, store, handle, use

or sell explosives or blasting agents to any applicant who has not provided on the permit application the name and signature of a designated individual as representing the applicant. When, as provided for in Section 107.2 or 107.6, a permit is required to conduct a fireworks display, as a condition of permit as provided for in Section 107.5, the fire official shall not issue a permit to design, setup or conduct a fireworks display to any applicant who has not provided on the permit application the name and signature of a designated individual as representing the applicant.

If the applicant's designated individual changes or becomes no longer qualified to represent the applicant as responsible management or designated individual, the applicant shall notify the fire official who issued the permit on the change of status of the designated individual. The notice is to be made prior to the use of any explosives or conducting a fireworks display but in no case shall the notification occur more than seven days after the change of status and shall provide the name of another designated individual. The fire official may revoke or require the reissuance of a permit based on a change of permit conditions or status or inability to provide another designated individual.

~~3301.2.3.1.1~~ 5601.2.3.1.1. BCC: The SFMO shall process all applications for a BCC for compliance with § 27-97.2 of the Code of Virginia and will be the sole provider of a BCC. Using forms provided by the SFMO, a BCC may be applied for and issued to any person who submits to the completion of a background investigation by providing fingerprints and personal descriptive information to the SFMO. The SFMO shall forward the fingerprints and personal descriptive information to the Central Criminal Records Exchange for submission to the Federal Bureau of Investigation for the purpose of obtaining a national criminal history records check regarding such applicant.

~~3301.2.3.1.2~~ 5601.2.3.1.2. Issuance of a ~~background clearance card~~ BCC: The issuance of a ~~background clearance card~~ BCC shall be denied if the applicant or designated person representing an applicant has been convicted of any felony, whether such conviction occurred under the laws of the Commonwealth, or any other state, the District of Columbia, the United States or any territory thereof, unless his civil rights have been restored by the Governor or other appropriate authority.

~~3301.2.3.1.3~~ 5601.2.3.1.3. Fee for ~~background clearance card~~ BCC: The fee for obtaining or renewing a ~~background clearance card~~ BCC from the SFMO shall be \$150 plus any additional fees charged by other agencies for fingerprinting and for obtaining a national criminal history record check through the Central Criminal Records Exchange to the Federal Bureau of Investigation.

~~3301.2.3.1.4~~ 5601.2.3.1.4. Revocation of a ~~background clearance card~~ BCC: After issuance of a ~~background clearance card~~ BCC, subsequent conviction of a felony will be grounds for immediate revocation of a ~~background~~

~~clearance card~~ BCC, whether such conviction occurred under the laws of the Commonwealth, or any other state, the District of Columbia, the United States or any territory thereof. The ~~card~~ BCC shall be returned to the SFMO immediately. An individual may reapply for his ~~background clearance card~~ BCC if his civil rights have been restored by the Governor or other appropriate authority.

~~3301.2.4~~ 5601.2.4. Financial responsibility. Before a permit is issued, as required by Section ~~3301.2~~ 5601.2, the applicant shall file with the jurisdiction a corporate surety bond in the principal sum of \$500,000 or a public liability insurance policy for the same amount, for the purpose of the payment of all damages to persons or property which arise from, or are caused by, the conduct of any act authorized by the permit upon which any judicial judgment results. The legal department of the jurisdiction may specify a greater amount when conditions at the location of use indicate a greater amount is required. Government entities shall be exempt from this bond requirement.

~~3301.2.4.1~~ 5601.2.4.1. Blasting. Before approval to do blasting is issued, the applicant for approval shall file a bond or submit a certificate of insurance in such form, amount, and coverage as determined by the legal department of the jurisdiction to be adequate in each case to indemnify the jurisdiction against any and all damages arising from permitted blasting but in no case shall the value of the coverage be less than ~~\$500,000~~ \$1,000,000.

Exception: Filing a bond or submitting a certificate of liability insurance is not required for blasting on real estate parcels of five or more acres conforming to the definition of "real estate devoted to agricultural use" or "real estate devoted to horticultural use" in § 58.1-3230 of the Code of Virginia and conducted by the owner of such real estate.

~~3301.2.4.2~~ 5601.2.4.2. Fireworks display. The permit holder shall furnish a bond or certificate of insurance in an amount deemed adequate by the legal department of the jurisdiction for the payment of all potential damages to a person or persons or to property by reason of the permitted display, and arising from any acts of the permit holder, the agent, employees or subcontractors, but in no case shall the value of the coverage be less than ~~\$500,000~~ \$1,000,000.

F. Change entire Section ~~3301.4~~ 5601.4 to read:

~~3301.4~~ 5601.4. Qualifications. Persons in charge of magazines, blasting, fireworks display, or pyrotechnic special effect operations shall not be under the influence of alcohol or drugs which impair sensory or motor skills, shall be at least 21 years of age and possess knowledge of all safety precautions related to the storage, handling or use of explosives, explosive materials or fireworks.

~~3301.4.1~~ 5601.4.1. Certification of blasters and pyrotechnicians. Certificates as a restricted blaster, unrestricted blaster or pyrotechnician will be issued upon proof of successful completion of an examination approved

Regulations

by the SFMO commensurate to the certification sought and completion of a background investigation for compliance with § 27-97.2 of the Code of Virginia. The applicant for certification shall submit proof to the SFMO of the following experience:

1. For certification as a restricted blaster, at least one year under direct supervision by a certified unrestricted blaster, certified restricted blaster or other person(s) approved by the SFMO.
2. For certification as an unrestricted blaster, at least one year under direct supervision by a certified unrestricted blaster or other person or persons approved by the SFMO.
3. For certification as a pyrotechnician, aerial, or pyrotechnician, proximate, applicant was in responsible charge of or has assisted in the documented design, setup and conducting of a fireworks display on at least six occasions within the 24 months immediately preceding the application for certification.

The SFMO shall process all certification applicants for compliance with § 27-97.2 of the Code of Virginia and will be the sole provider of blaster and pyrotechnician certifications.

Exception: The use of explosives by the owner of real estate parcels of five or more acres conforming to the definition of "real estate devoted to agricultural use" or "real estate devoted to horticultural use" in § 58.1-3230 of the Code of Virginia when blasting on such real estate.

~~3301.4.2~~ 5601.4.2. Certification issuance. The issuance of a certification as a blaster or pyrotechnician shall be denied if the applicant has (i) been convicted of any felony, whether such conviction occurred under the laws of the Commonwealth, or any other state, the District of Columbia, the United States or any territory thereof, unless his civil rights have been restored by the Governor or other appropriate authority, (ii) has not provided acceptable proof or evidence of the experience required in Section ~~3301.4.1~~ 5601.4.1, or (iii) has not provided acceptable proof or evidence of the continued training or education required in Section ~~3301.4.5~~ 5601.4.5.

~~3301.4.3~~ 5601.4.3. Fee for certification. The fee for obtaining or renewing a blaster or pyrotechnician certificate from the SFMO shall be \$150 plus any additional fees charged by other agencies for fingerprinting and for obtaining a national criminal history record check through the Central Criminal Records Exchange to the Federal Bureau of Investigation.

~~3301.4.4~~ 5601.4.4. Revocation of a blaster or pyrotechnician certification. After issuance of a blaster or pyrotechnician certification, subsequent conviction of a felony will be grounds for immediate revocation of a blaster or pyrotechnician certification, whether such conviction occurred under the laws of the Commonwealth,

or any other state, the District of Columbia, the United States or any territory thereof. The certification shall be returned to the SFMO immediately. An individual may subsequently reapply for his blaster or pyrotechnician certification if his civil rights have been restored by the Governor or other appropriate authority.

~~3301.4.5~~ 5601.4.5. Expiration and renewal of a BCC, or blaster or pyrotechnician certification. A certificate for an unrestricted blaster, restricted blaster or pyrotechnician shall be valid for three years from the date of issuance. A BCC shall be valid for three years from the date of issuance. Renewal of the unrestricted blaster certificate will be issued upon proof of at least 16 accumulated hours of continued training or education in the use of explosives within three consecutive years and a background investigation for compliance with § 27-97.2 of the Code of Virginia. Renewal of the restricted blaster certificate will be issued upon proof of at least eight accumulated hours of continued training or education in the use of explosives within three consecutive years and a background investigation for compliance with § 27-97.2 of the Code of Virginia. Renewal of the pyrotechnician certificate will be issued upon proof of at least 12 accumulated hours of continued training or education in the subject areas of explosives storage; the design, setup or conduct of a fireworks display within three consecutive years; and a background investigation for compliance with § 27-97.2 of the Code of Virginia. The continued training or education required for renewal of a blaster or pyrotechnician certificate shall be obtained during the three years immediately prior to the certificate's published expiration date. Failure to renew a blaster or pyrotechnician certificate in accordance with this section shall cause an individual to obtain another blaster or pyrotechnician certificate upon compliance with Section ~~3301.4.1~~ 5601.4.1 to continue engaging in the unsupervised use of explosives or conducting a fireworks display.

G. Change Section ~~3301.7~~ 5601.7 to read:

~~3301.7~~ 5601.7. Seizure. The fire official is authorized to remove or cause to be removed or disposed of in an approved manner, at the expense of the owner, fireworks offered or exposed for sale, stored, possessed or used in violation of this chapter.

H. Add the following to the list of definitions to ~~in~~ Section ~~3302.1~~ 5602.1:

~~Background clearance card (BCC). An identification card issued to an individual who is not a certified blaster or pyrotechnician and is responsible management or an employee of a company, corporation, firm or other entity, solely for the purpose of submitting an application to the fire official for a permit to manufacture, use, handle, store, or sell explosive materials; or conduct a fireworks display. A person to whom a BCC has been issued can fulfill the role of a designated individual on an application for a~~

permit to manufacture, use, handle, store, or sell explosive materials; or on an application for a permit to design, setup and conduct a fireworks display.

Blaster, restricted. Any person engaging in the use of explosives or blasting agents utilizing five pounds (2.25 kg) or less per blasting operation and using instantaneous detonators. A certified restricted blaster can fulfill the role of a designated individual on an application for permit to manufacture, use, handle, store, or sell explosive materials.

Blaster, unrestricted. Any person engaging in the use of explosives or blasting agents without limit to the amount of explosives or blasting agents or type of detonator. A certified unrestricted blaster can fulfill the role of a designated individual on an application for permit to manufacture, use, handle, store, or sell explosive materials.

Design. For the purposes of a fireworks display, either inside a building or structure or outdoors, it shall mean the pyrotechnician who will be in attendance and makes the final artistic determination for the placement of fireworks and ground display pieces suitable for the display site.

Designated individual. A person who is in possession of a BCC issued by the SFMO, certified by the SFMO as a pyrotechnician, or a restricted or unrestricted blaster, any of whom are responsible for ensuring compliance with state law and regulations relating to blasting agents and explosives and applying for explosives or firework permits; is at least 21 years of age; and demonstrates the capability to effectively communicate safety messages verbally and in writing in the English language.

Fireworks.

Fireworks, 1.4G.

Fireworks, 1.3G.

Permissible fireworks. Any sparklers, fountains, Pharaoh's serpents, caps for pistols, or pinwheels commonly known as whirligigs or spinning jennies.

Pyrotechnician (fireworks operator). Any person supervising or engaged in the design, setup or conducting of any fireworks display, either inside a building or outdoors. A certified pyrotechnician can fulfill the role of a designated individual on an application for a permit for a fireworks display.

Pyrotechnician, aerial. A person supervising or engaged in the design, setup or conducting of a outdoor aerial fireworks display performed in accordance with the regulations as set forth in this code and NFPA 1123, a referenced standard for fireworks displays.

Pyrotechnician, proximate. A person supervising or engaged in the design, setup or conducting of a fireworks display, either inside a building or outdoors, performed in accordance with the regulations as set forth in this code and NFPA 1126, a referenced standard for the use of pyrotechnics before a proximate audience.

Responsible management. A person who is any of the following:

1. The sole proprietor of a sole proprietorship.
2. The partners of a general partnership.
3. The managing partners of a limited partnership.
4. The officers of a corporation.
5. The managers of a limited liability company.
6. The officers or directors of an association, or both.
7. Individuals in other business entities recognized under the laws of the Commonwealth as having a fiduciary responsibility to the firm.

Smokeless propellants.

Sole proprietor. A person or individual, not a corporation, who is trading under his own name or under an assumed or fictitious name pursuant to the provisions of § 59.1-69 through 59.1-76 of the Code of Virginia.

I. Change the following definitions in Section 3302.1 to read:

Fireworks. Any firecracker, torpedo, skyrocket, or other substance or object, of whatever form or construction, that contains any explosive or inflammable compound or substance, and is intended, or commonly known, as fireworks and that explodes, rises into the air or travels laterally, or fires projectiles into the air. Fireworks shall not include automobile flares, paper caps containing not more than an average of 0.25 grain (16 mg) of explosive content per cap or toy pistols, toy canes, toy guns or other devices utilizing such caps and items commonly known as party poppers, pop rocks and snap n pops. Fireworks may be further delineated and referred to as:

Fireworks, 1.4G. (Formerly known as Class C, Common Fireworks.) Small fireworks devices containing restricted amounts of pyrotechnic composition designed primarily to produce visible or audible effects by combustion. Such 1.4G fireworks that comply with the construction, chemical composition, and labeling regulations of the DOTn for Fireworks, UN 0336, and the U.S. Consumer Product Safety Commission as set forth in CPSC 16 CFR: Parts 1500 and 1507, are not explosive materials for the purpose of this code.

Fireworks, 1.3G. (Formerly Class B, Special Fireworks.) Large fireworks devices, which are explosive materials, intended for use in fireworks displays and designed to produce audible or visible effects by combustion, deflagration, or detonation. Such 1.3G fireworks include, but are not limited to, firecrackers containing more than 130 milligrams (2 grains) of explosive composition, aerial shells containing more than 40 grams of pyrotechnic composition, and other display pieces that exceed the limits for classification as 1.4G fireworks. Such 1.3G fireworks are also described as Fireworks, UN0335 by the DOTn.

Regulations

~~Smokeless propellants. Solid propellants, commonly referred to as smokeless powders or any propellant classified by DOT as a smokeless propellant in accordance with "NA3178, Smokeless Powder for Small Arms," used in small arms ammunition, firearms, cannons, rockets, propellant actuated devices, and similar articles.~~

~~J. I.~~ Change Section ~~3305.1~~ 5605.1 to read:

~~3305.1~~ 5605.1. General. The manufacture, assembly and testing of explosives, ammunition, blasting agents and fireworks shall comply with the requirements of this section, Title 59.1, Chapter 11 of the Code of Virginia, and NFPA 495 or NFPA 1124.

Exceptions:

1. The hand loading of small arms ammunition prepared for personal use and not offered for resale.
2. The mixing and loading of blasting agents at blasting sites in accordance with NFPA 495.
3. The use of binary explosives or phosphoric materials in blasting or pyrotechnic special effects applications in accordance with NFPA 495 or NFPA 1126.

~~K. J.~~ Add Section ~~3305.1.1~~ 5605.1.1 to read:

~~3305.1.1~~ 5605.1.1. Permits. Permits for the manufacture, assembly and testing of explosives, ammunition, blasting agents and fireworks shall be required as set forth in Section 107.2 and regulated in accordance with this section. A permit to manufacture any explosive material in any quantity shall be prohibited unless such manufacture is authorized by a federal license and conducted in accordance with recognized safety practices.

~~L. K.~~ Change Section ~~3306.4~~ 5606.4 to read:

~~3306.4~~ 5606.4. Storage in residences. Propellants for personal use in quantities not exceeding 50 pounds (23 kg) of black powder or 100 pounds (45 kg) of smokeless powder shall be stored in original containers in occupancies limited to ~~Group~~ Groups R-3 and R-5, or 200 pounds (91 kg) of smokeless powder when stored in the manufacturer's original containers in detached Group U structures that are at least 10 feet from inhabited buildings and are accessory to Group R-3 or R-5. In other than Group R-3 or R-5, smokeless powder in quantities exceeding 20 pounds (9 kg) but not exceeding 50 pounds (23 kg) shall be kept in a wooden box or cabinet having walls of at least one inch (25 mm) nominal thickness or equivalent.

~~M. L.~~ Delete Sections ~~3306.4.1~~ 5606.4.1, ~~5606.4.2~~ 5606.4.2, and ~~3306.4.3~~ 5606.4.3.

~~N. M.~~ Change Section ~~3306.5.1.1~~ 5606.5.1.1 to read:

~~3306.5.1.1~~ 5606.5.1.1. Smokeless propellant. No more than 100 pounds (45 kg) of smokeless propellants, in containers of 8 pounds (3.6 kg) or less capacity, shall be displayed in Group M occupancies.

~~O. N.~~ Delete Section ~~3306.5.1.3~~ 5606.5.1.3.

~~P. O.~~ Change Section ~~3306.5.2.1~~ 5606.5.2.1 to read:

~~3306.5.2.1~~ 5606.5.2.1 Smokeless propellant. Commercial stocks of smokeless propellants shall be stored as follows:

1. Quantities exceeding 20 pounds (9 kg), but not exceeding 100 pounds (45 kg) shall be stored in portable wooden boxes having walls of at least one inch (25 mm) nominal thickness or equivalent.

2. Quantities exceeding 100 pounds (45 kg), but not exceeding 800 pounds (363 kg), shall be stored in storage cabinets having walls at least one inch (25 mm) nominal thickness or equivalent. Not more than 400 pounds (182 kg) shall be stored in any one cabinet, and cabinets shall be separated by a distance of at least 25 feet (7620 mm) or by a fire partition having a fire-resistance rating of at least one hour.

3. Storage of quantities exceeding 800 pounds (363 kg), but not exceeding 5,000 pounds (2270 kg) in a building shall comply with all of the following:

3.1. The storage is inaccessible to unauthorized personnel.

3.2. Smokeless propellant shall be stored in nonportable storage cabinets having wood walls at least one inch (25 mm) nominal thickness or equivalent and having shelves with no more than three feet (914 mm) of vertical separation between shelves.

3.3. No more than 400 pounds (182 kg) is stored in any one cabinet.

3.4. Cabinets shall be located against walls with at least 40 feet (12 192 mm) between cabinets. The minimum required separation between cabinets may be reduced to 20 feet (6096 mm) provided that barricades twice the height of the cabinets are attached to the wall, midway between each cabinet. The barricades must extend a minimum of 10 feet (3048 mm) outward, be firmly attached to the wall, and be constructed of steel not less than 0.25 inch thick (6.4 mm), two-inch (51 mm) nominal thickness wood, brick, or concrete block.

3.5. Smokeless propellant shall be separated from materials classified as combustible liquids, flammable liquids, flammable solids, or oxidizing materials by a distance of 25 feet (7620 mm) or by a fire partition having a fire-resistance rating of one hour.

3.6. The building shall be equipped throughout with an automatic sprinkler system installed in accordance with Section 903.3.1.1.

4. Smokeless propellants not stored according to Item 1, 2, or 3 above shall be stored in a Type 2 or 4 magazine in accordance with Section 3304 and NFPA 495.

~~Q. P.~~ Change Section ~~3307.1~~ 5607.1 to read:

~~3307.1~~ 5607.1. General. Blasting operations shall be conducted only by persons certified by the SFMO as a restricted or unrestricted blaster or shall be supervised on-

site by a person properly certified by the SFMO as a restricted or unrestricted blaster.

~~R. Q.~~ Add Section ~~3307.16~~ 5607.16 to read:

~~3307.16~~ 5607.16. Blast records. A record of each blast shall be kept and retained for at least five years and shall be available for inspection by the code official. The record shall contain the following minimum data:

1. Name of contractor;
2. Location and time of blast;
3. Name of certified blaster in charge;
4. Type of material blasted;
5. Number of holes bored and spacing;
6. Diameter and depth of holes;
7. Type and amount of explosives;
8. Amount of explosive per delay of 8 milliseconds or greater;
9. Method of firing and type of circuit;
10. Direction and distance in feet to nearest dwelling, public building, school, church, commercial or institutional building;
11. Weather conditions;
12. Whether or not mats or other precautions were used;
13. Type of detonator and delay period;
14. Type and height of stemming; and
15. Seismograph record when utilized.

Exception: Subdivisions 8 and 13 of this section are not applicable to restricted blasters.

~~S. R.~~ Change Section ~~3308.2~~ 5608.2 to read:

~~3308.2~~ 5608.2. Permit application. Prior to issuing permits for a fireworks display, plans for the fireworks display, inspections of the display site and demonstrations of the display operations shall be approved. A plan establishing procedures to follow and actions to be taken in the event that a shell fails to ignite in, or discharge from, a mortar or fails to function over the fallout area or other malfunctions shall be provided to the fire code official.

In addition to the requirements of Section ~~3301.2.3.1~~ 5601.2.3.1, a permit to conduct a fireworks display shall not be issued to any applicant without the applicant identifying on the application the pyrotechnician who will

be in responsible charge of the fireworks display and who is appropriately certified as a pyrotechnician in accordance with Section ~~3301.4.1~~ 5601.4.1.

Exception: Permits are not required for the use or display of permissible fireworks on private property with the consent of the owner of such property.

~~T. S.~~ Change Section ~~3308.3~~ 5608.3 to read:

~~3308.3~~ 5608.3. Approved fireworks displays. Approved fireworks displays shall include only the approved fireworks 1.3G, fireworks 1.4G, fireworks 1.4S and pyrotechnic articles 1.4G. The design, setup, conducting or direct on-site supervision of the design, setup and conducting of any fireworks display, either inside a building or outdoors, shall be performed only by persons certified by the SFMO in accordance with Section ~~3301.4.1~~ 5601.4.1 as a pyrotechnician (firework operator) and at least one person properly certified by the SFMO as a pyrotechnician shall be present at the site where the fireworks display is being conducted. The approved fireworks shall be arranged, located, discharged and fired in a manner that will not pose a hazard to property or endanger any person.

Exception: Certification as a pyrotechnician is not required for the use or display of permissible fireworks when conducted on private property with the consent of the owner of such property.

~~U. T.~~ Change Section ~~3308.4~~ 5608.4 to read:

~~3308.4~~ 5608.4 Clearance. Spectators, spectator parking areas, and dwellings, buildings or structures shall not be located within the display site. The site for the outdoor land or water display shall have at least 100-ft/in. (31-m/2.4mm) radius of internal mortar distance of the largest shell to be fired as shown in Table ~~3308.4~~ 5608.4.

Exceptions:

1. This provision shall not apply to pyrotechnic special effects and fireworks displays using Division 1.4G materials before a proximate audience in accordance with NFPA 1126.
2. This provision shall not apply to unoccupied dwellings, buildings and structures with the approval of the building owner and the fire code official.

~~V. U.~~ Add Table ~~3308.4~~ 5608.4 to read:

Table ~~3308.4~~ 5608.4.

Distances for Outdoor Fireworks Display Sites: Minimum Separation Distances from Mortars to Spectators for Land and Water Displays.									
Mortar Size ^a		Minimum Secured Diameter of Site		Vertical Mortars ^b		Angled Mortars ^c 1/3 offset		Mortars to Special Hazards ^d	
in.	mm	ft	m	ft	m	ft	m	ft	m
<3	<76	300	92	150	46	100	31	300	92

Regulations

3	76	600	183	300	92	200	61	600	183
4	102	800	244	400	122	266	81	800	244
5	127	1000	305	500	152	334	102	1000	305
6	152	1200	366	600	183	400	122	1200	366
7	178	1400	427	700	213	467	142	1400	427
8	203	1600	488	800	244	534	163	1600	488
10	254	2000	610	1000	305	667	203	2000	610
12	305	2400	732	1200	366	800	244	2400	732
>12	Requires the approval of the fire official								

^aAerial shells, mines, and comets shall be classified and described only in terms of the inside diameter of the mortar from which they are fired (e.g., 3-in. (76-mm) aerial shells, mines and comets are only for use in 3-in. (76mm) mortars).

^bWhere the mortars are positioned vertically, the mortars shall be placed at the approximate center of the display site.

^cMortars shall be permitted to be angled during a display to allow for wind and to carry shells away from the main spectator viewing areas. For angled mortars, the minimum secured diameter of the display site does not change. Only the location of the mortars within the secured area changes when the mortars are angled.

^dNote that this is only the distance to the special hazards. The minimum secured diameter of the display site does not change.

V. Add Sections 5608.4.1 and 5608.4.2 to read:

5608.4.1. Non-splitting, non-bursting comets and mines. For non-splitting or non-bursting comets and mines containing only stars or non-splitting or non-bursting comets, the minimum required radius of the display site shall be 50 feet per inch (15.24 m per 25.4 mm) of the internal mortar diameter of the largest comet or mine to be fired, one-half that shown in Table 5608.4.

5608.4.2. Special distance requirements. The minimum distance requirements of Table 5608.4 shall be adjusted as follows:

1. For chain-fused aerial shells and comets and mines to be fired from mortars, racks, or other holders that are sufficiently strong to prevent their being repositioned in the event of an explosive malfunction of the aerial shells, comets, or mines, the minimum required radius shall be the same as that required in Sections 5608.4 and 5608.4.1. For chain-fused aerial shells and comets and mines to be fired from mortars, racks, or other holders that are not sufficiently strong to prevent their being repositioned in the event of an explosive malfunction of the aerial shells, comets, or mines, or if there is doubt concerning the strength of racks holding chain-fused mortars, based upon the largest mortar in the sequence, the minimum required radius shall be double that required in Sections 5608.4 and 5608.4.1.

2. Distances from the point of discharge of any firework to a health care or detention and correctional facility, or the bulk storage of materials that have flammability, explosive, or toxic hazard shall be at least twice the distances specified in Table 5608.4.

3. The minimum required spectator separation distance for roman candles and cakes that produce aerial shells, comets, or mine effects shall be the same as the minimum required radius specified in Table 5608.4.

4. Aerial shells, comets and mines, and roman candles and cakes shall be permitted to be angled if the dud shells or components are carried away from the main spectator area and either of the following requirements is satisfied:

4.1. The offset specified in Table 5608.4 is followed.

4.2. The separation distance is correspondingly increased in the direction of the angle.

If the offset provided in Table 5608.4 is followed, the mortars or tubes shall be angled so that any dud shells or components fall at a point approximately equal to the offset of the mortars or tubes from the otherwise required discharge point but in the opposite direction.

13VAC5-51-154. IFC Chapter 38 61. Liquefied Petroleum Gases.

A. Change Section ~~3801.2~~ 6101.2 to read:

~~3801.2~~ 6101.2. Permits. Permits shall be required as set forth in Section 107.2. Distributors shall not fill an LP-gas container for which a permit is required unless a permit for installation has been issued for that location by the fire code official, except when the container is for temporary use on construction sites.

B. Add Section ~~3806.4~~ 6106.4 to read:

~~3806.4~~ 6106.4. ~~DOT~~ DOT_n cylinders filled on site. ~~DOT~~ DOT_n cylinders in stationary service that are filled on site and therefore are not under the jurisdiction of ~~DOT~~ DOT_n either shall be requalified in accordance with ~~DOT~~ DOT_n

requirements or shall be visually inspected within 12 years of the date of manufacture or within five years from May 1, 2008, whichever is later, and within every five years thereafter, in accordance with the following:

1. Any cylinder that fails one or more of the criteria in Item 3 shall not be refilled or continued in service until the condition is corrected.
2. Personnel shall be trained and qualified to perform inspections.
3. Visual inspection shall be performed in accordance with the following:
 - 3.1. The cylinder is checked for exposure to fire, dents, cuts, digs, gouges, and corrosion according to CGA C-6, Standards for Visual Inspection of Steel Compressed Gas Cylinders, except that paragraph 4.2.1(1) of that standard (which requires tare weight certification), shall not be part of the required inspection criteria.
 - 3.2. The cylinder protective collar (where utilized) and the foot ring are intact and are firmly attached.
 - 3.3. The cylinder is painted or coated to retard corrosion.
 - 3.4. The cylinder pressure relief valve indicates no visible damage, corrosion of operating components, or obstructions.
 - 3.5. There is no leakage from the cylinder or its appurtenances that is detectable without the use of instruments.
 - 3.6. The cylinder is installed on a firm foundation and is not in contact with the soil.
 - 3.7. A cylinder that passed the visual inspection shall be marked with the month and year of the examination followed by the letter "E" (example: 10-01E, indicating requalification in October 2001 by the external inspection method).
 - 3.8. The results of the visual inspection shall be documented, and a record of the inspection shall be retained for a five-year period.

Exception: Any inspection procedure outlined in Items 3.1 through 3.8 that would require a cylinder be moved in such a manner that disconnection from the piping system would be necessary shall be omitted, provided the other inspection results do not indicate further inspection is warranted.

C. Add Sections 3809.15 and 3809.15.1 to read:

~~3809.15. LP Gas cylinder exchange for resale. In addition to other applicable requirements of this chapter, facilities operating cylinder exchange stations for LP gas that are accessible to the public shall comply with the following requirements:~~

- ~~1. Cylinders shall be secured in a lockable, ventilated metal cabinet or other approved enclosure.~~

~~2. Cylinders shall be accessible only by authorized personnel or by use of an automated exchange system in accordance with Section 3809.15.1.~~

~~3. A sign shall be posted on the entry door of the business operating the cylinder exchange stating "DO NOT BRING LP GAS CYLINDERS INTO THE BUILDING" or similar approved wording.~~

~~4. An emergency contact information sign shall be posted within 10 feet of the cylinder storage cabinet. The content, lettering, size, color and location of the required sign shall be as required by the fire code official.~~

~~3809.15.1. Automated Cylinder Exchange Stations. Cylinder exchange stations that include an automated vending system for exchanging cylinders shall comply with the following additional requirements:~~

- ~~1. The vending system shall only permit access to a single cylinder per individual transaction.~~
- ~~2. Cabinets storing cylinders shall be designed such that cylinders can only be placed inside when they are oriented in the upright position.~~
- ~~3. Devices operating door releases for access to stored cylinders shall be permitted to be pneumatic, mechanical or electrically powered.~~
- ~~4. Electrical equipment inside of or within 5 feet of a cabinet storing cylinders, including but not limited to electronics associated with vending operations, shall comply with the requirements for Class 1, Division 2 equipment in accordance with NFPA 70.~~
- ~~5. A manual override control shall be permitted for use by authorized personnel. On newly installed cylinder exchange stations, the vending system shall not be capable of returning to automatic operation after a manual override until the system has been inspected and reset by authorized personnel.~~
- ~~6. Inspections shall be conducted by authorized personnel to verify that all cylinders are secured, access doors are closed and the station has no visible damage or obvious defects that necessitate placing the station out of service. The frequency of inspections shall be as specified by the fire code official.~~

D. C. Change Section 3811.2 6111.2 to read:

~~3811.2 6111.2. Unattended parking. The unattended parking of LP-gas tank vehicles shall be in accordance with Sections 3811.2.1 6111.2.1 and 3811.2.2 6111.2.2.~~

Exception: The unattended outdoor parking of LP-gas tank vehicles may also be in accordance with Section 9.7.2 of NFPA 58.

13VAC5-51-154.5. IFC Chapter 46. Construction Requirements for Existing Buildings. (Repealed.)

Delete Chapter 46 in its entirety.

Regulations

13VAC5-51-155. IFC Chapter 47 80. Referenced Standards.

Change the referenced standards as follows (standards not shown remain the same):

Standard reference number	Title	Referenced in code section number
CGA C-6 (2001)	Standards for Visual Inspection of Steel Compressed Gas Cylinders	3806.4 6106.4
UL 1037-99	Standard for Antitheft Alarms and Devices	506.1
UL 1278-00	Standard for Movable and Wall- or Ceiling-Hung Electric Room Heaters	605.10.1

DOCUMENTS INCORPORATED BY REFERENCE (13VAC5-51)

The International Fire Code – ~~2009~~ 2012 Edition, International Code Council, Inc., 500 New Jersey Avenue, NW, 6th Floor, Washington, DC 20001-2070

CGA C-6 – 2001, Standards for Visual Inspection of Steel Compressed Gas Cylinders, Eighth Edition, Compressed Gas Association, 1725 Jefferson Davis Highway, 5th Floor, Arlington, VA 22202-4102

National Fire Protection Association, 1 Batterymarch Park, Quincy, MA 02169-7471 (<http://www.nfpa.org>):

~~NFPA 58-04 58-11, Liquefied Petroleum Gas Code, 2004 Edition, National Fire Protection Association, Batterymarch Park, Quincy, MA 02269~~

~~NFPA 70-08 70-11, National Electrical Code, 2008 Edition, National Fire Protection Association, Batterymarch Park, Quincy, MA 02269~~

~~NFPA 72-07 72-10, National Fire Alarm and Signaling Code, 2007 Edition, National Fire Protection Association, Batterymarch Park, Quincy, MA 02269~~

NFPA 495-10, Explosives Materials Code

NFPA 701-10, Standard Methods of Fire Tests for Flame - Propagation of Textiles and Films

~~NFPA 1123-06 1123-10, Code for Fireworks Display, 2006 Edition, National Fire Protection Association, Batterymarch Park, Quincy, MA 02269~~

NFPA 1124-06, Code for the Manufacture, Transportation, Storage, and Retail Sales of Fireworks and Pyrotechnic Articles

~~NFPA 1126-06 1126-11, Standard for the Use of Pyrotechnics Before a Proximate Audience, 2006 Edition, National Fire Protection Association, Batterymarch Park, Quincy, MA 02269~~

~~UL 1037-99, Standard for Antitheft Alarms and Devices, Fifth Edition, February 24, 1999, Underwriters Laboratories, Inc., Northbrook, IL 60062~~

UL 1278-00, Standard for Movable and Wall- or Ceiling-Hung Electric Room Heaters, Third Edition, June 21, 2000, Underwriters Laboratories, Inc., Northbrook, IL 60062

V.A.R. Doc. No. R12-3161; Filed June 27, 2013, 9:54 a.m.

Proposed Regulation

REGISTRAR'S NOTICE: The Board of Housing and Community Development is claiming an exemption from the Administrative Process Act pursuant to § 2.2-4006 A 12 of the Code of Virginia, which excludes regulations adopted by the Board of Housing and Community Development pursuant to the Uniform Statewide Building Code (§ 36-97 et seq. of the Code of Virginia).

Title of Regulation: **13VAC5-63. Virginia Uniform Statewide Building Code (amending 13VAC5-63-10, 13VAC5-63-20, 13VAC5-63-30, 13VAC5-63-40, 13VAC5-63-80, 13VAC5-63-110, 13VAC5-63-120, 13VAC5-63-130, 13VAC5-63-160, 13VAC5-63-170, 13VAC5-63-180, 13VAC5-63-190, 13VAC5-63-200, 13VAC5-63-210, 13VAC5-63-220, 13VAC5-63-230, 13VAC5-63-240, 13VAC5-63-245, 13VAC5-63-250, 13VAC5-63-260, 13VAC5-63-264, 13VAC5-63-270, 13VAC5-63-280, 13VAC5-63-300, 13VAC5-63-310, 13VAC5-63-320, 13VAC5-63-330, 13VAC5-63-350, 13VAC5-63-360, 13VAC5-63-390, 13VAC5-63-400, 13VAC5-63-410, 13VAC5-63-420, 13VAC5-63-430, 13VAC5-63-434, 13VAC5-63-438, 13VAC5-63-440, 13VAC5-63-450, 13VAC5-63-460, 13VAC5-63-470, 13VAC5-63-480, 13VAC5-63-490, 13VAC5-63-500, 13VAC5-63-510, 13VAC5-63-520, 13VAC5-63-530, 13VAC5-63-540; adding 13VAC5-63-225, 13VAC5-63-235, 13VAC5-63-295, 13VAC5-63-335, 13VAC5-63-445; repealing 13VAC5-63-267, 13VAC5-63-525).**

Statutory Authority: § 36-98 of the Code of Virginia.

Public Hearing Information:

September 23, 2013 - 10 a.m. - Virginia Housing Center, 4224 Cox Road, Glen Allen, VA

Public Comment Deadline: September 29, 2013.

Agency Contact: Stephen W. Calhoun, Regulatory Coordinator, Department of Housing and Community Development, Main Street Centre, 600 East Main Street, Suite 300, Richmond, VA 23219, telephone (804) 371-7000,

FAX (804) 371-7090, TTY (804) 371-7089, or email steve.calhoun@dhcd.virginia.gov.

Background: The Virginia Uniform Statewide Building Code (USBC) governs the construction, maintenance, and rehabilitation of new and existing buildings and structures. The USBC uses nationally recognized model building codes and standards produced by the International Code Council and other standard-writing groups as the basis for the technical provisions of the regulation. Every three years, new editions of the model codes become available. At that time, the Board of Housing and Community Development initiates a regulatory action to incorporate the newest editions of the model codes into regulation through the publishing of a proposed regulation. Those affected by the regulation review the proposed regulation to assure that the newest model codes and standards reflect the minimum requirements necessary for buildings and structures. After publication of the proposed regulation, the board establishes a comment period for the acceptance of comments on amendments reflected in the proposed regulation and a public hearing is held. The board then considers comments on all proposals and develops a final regulation to complete the regulatory process.

Summary:

The substantive amendments in this regulatory action include the following:

13VAC5-63-20 D (8): Adds "Off-site manufactured intermodal freight containers, moving containers, and storage containers placed on site temporarily or permanently for use as a storage container" to the exemptions from this code.

13VAC5-63-20 D (9): Adds "Automotive lifts" to the exemptions from this code.

13VAC5-63-30 G: Deletes existing language and adds language that requires compliance with the Virginia Rehabilitation Code (VRC) as related to reconstruction, alteration, and repairs in occupancies other than Group R-5.

13VAC5-63-80 B (12): Adds crypts, mausoleums, and columbaria structures to exemptions from application for permit.

13VAC5-63-120 A through X: These provisions were approved under a prior action of the board under special provisions for defective materials and were only effective for two years. This action will make the provisions a permanent part of the USBC.

13VAC5-63-170 B: Adds this subsection for temporary uses within existing buildings and structures; allows the building official to approve conditions or modifications for temporary use; and stipulates that the building official shall notify the fire official of the approved temporary use and is allowed to terminate the approval.

13VAC5-63-180 D (new E): Deletes some existing language applicable to vacating unsafe buildings or

structures and clarifies that the building official is authorized to order the building or structure to be vacated immediately if there is imminent danger to the occupants or to the public.

13VAC5-63-210 E: Changes Section 308.2 to Section 308.3 of the IBC for Institutional Group I-1; excludes residing staff from the number of persons residing on a 24-hour basis who receive custodial care; specifies section to be referenced for Group I-1, other than assisted living facilities as Section 308.3.1; specifies assisted living facilities be classified as one of the occupancy conditions indicated in Section 308.3.1 or 308.3.2; clarifies the exception for Group I-1 occupancies as the occupancy condition indicated in Section 308.3.1; and deletes language that refers to a similar facility with five or fewer persons.

13VAC5-63-210 R 28 (new 27): Deletes the use of Appendix G for swimming pools, spas, and hot tubs. Swimming pools, as defined in the USBC, shall comply with the applicable provisions of the International Swimming Pool and Spa Code.

13VAC5-63-210 R 52 (new 43): Deletes all existing language and adds new language to Section R602.12 for practical wall bracing, which allows all buildings in Seismic Design Categories A and B and detached buildings in Category C to be permitted to be braced in accordance with this section as an alternative to Section R602.10. The revisions also add several sections relating to wall bracing requirements and procedures.

13VAC5-63-210 R (53): Changes Section N1102.4.1.2 (R402.4.1.2) for air sealing and requires compliance with either Section N1102.4.1.2.1 or Section N1102.4.1.2.2 and adds sections that (i) specify how the testing option shall be performed when testing for air leakage; (ii) provide that visual inspection is an option for air leakage compliance; and (iii) state that the air leakage rate shall not exceed five changes per hour.

13VAC5-63-210 R (56): Changes Section N1103.2.2.1 (R403.2.2.1) for testing options. Clarifies that the post-construction test shall be determined by the total leakage that is less than or equal to 6 cfm/100 square feet across the entire system; clarifies that the rough-in test shall be determined by the total leakage that is less than 5 cfm/100 square feet across the system; addresses the case where the air handler has yet to be installed, in this case the total leakage shall be less than or equal to 5 cfm/100 square feet; and revises the exception to indicate that the total leakage test not be required for ducts and air handlers located entirely within the building thermal envelope.

13VAC5-63-210 R (57): Adds Section N1103.2.2.2 (R403.2.2.2) for visual inspection option for compliance.

13VAC5-63-210 R (72): Adds Sections P2909.1 through P2909.18, including subsections for scope and design of

Regulations

nonpotable water systems, makeup water, makeup water sources, makeup water supply valves, control valve alarms, sizing, required signage, potable water supply system connections, nonpotable water system connections, approved components and materials, insect and vermin control, freeze protection, nonpotable water storage tanks, inlets, outlets, materials and location, foundation and supports, ballasts, structural support, overflow, access, venting, drains, storage tank tests, structural strength, trenching requirements, outdoor outlet access, drainage and vent piping fittings, pumping and control systems, water-pressure reducing valves or regulators, distribution pipes, materials, joints, and connections, design, labeling and marking, backflow prevention, tests and inspections, drainage and vent pipe tests, storage tanks tests, water supply system tests, inspection and testing of backflow prevention assemblies, inspection of vermin and insect protection, and operation and maintenance manuals.

13VAC5-63-220 M: Adds Section 425.2.1 to the IBC for relocated manufactured homes, which specifies that installation, setup, and site work shall comply with the provisions of this code and shall include the option of using the manufacturer's installation instructions or the federal Model Manufactured Home Installation Standards (24 CFR Part 3285) for the technical requirements.

13VAC5-63-220 N: Adds Section 425.2.2 to the IBC for alterations and repairs to manufactured homes, which specifies that alterations and repairs shall be in accordance with federal Manufactured Home Construction and Safety Standards (24 CFR Part 3280) or in accordance with the alteration and repair provisions of this code.

13VAC5-63-310 D (3), (4), and (5): Amends the IMC to permit residential-type electric stoves to be used in commercial buildings without the need of a commercial exhaust hood.

13VAC5-63-310 D (6) and (7): Modifies the IMC to permit water quality for cooling towers to be in accordance with the equipment manufacturer's recommendations to safely permit the use of rainwater or other nonpotable water sources in air-conditioning systems.

13VAC5-63-330 B: Amends the elevator chapter of the IBC to correlate with requirements for fire service elevator keys established in the IFC, which permit the use of either a standardized key or the use of a lock box for a non-standardized key.

13VAC5-63-350: Addresses existing buildings and contained provisions to be used for alterations, additions, and change of occupancy to existing buildings as well as setting out special retrofit requirements for existing buildings when required by state law. All

requirements in this section have been moved to Part II of the regulation (the VRC) so there remains a provision that deletes all of Chapter 34 of the IBC, as it is no longer used.

13VAC5-63-410 B: Changes the scope of the VRC to include mandatory requirements for the alteration and repair of buildings and for changes of occupancy in existing buildings, except for buildings in the Institutional grouping, where Part I of the regulation still applies and clarifies that the VRC may be used for alterations to residential buildings as an acceptable alternative to the use of Part I of the regulation.

Part I Construction

13VAC5-63-10. Chapter 1 Administration; Section 101 General.

A. Section 101.1 Short title. The Virginia Uniform Statewide Building Code, Part I, Construction, may be cited as the Virginia Construction Code or as the VCC. The term "USBC" shall mean the ~~Virginia Construction Code~~ VCC unless the context in which the term is used clearly indicates it to be an abbreviation for the entire Virginia Uniform Statewide Building Code or for a different part of the Virginia Uniform Statewide Building Code.

Note: This code is also known as the ~~2009~~ 2012 edition of the USBC due to the use of the ~~2009~~ 2012 editions of the model codes.

B. Section 101.2 Incorporation by reference. Chapters 2 - 35 of the ~~2009~~ 2012 International Building Code, published by the International Code Council, Inc., are adopted and incorporated by reference to be an enforceable part of the USBC. The term "IBC" means the ~~2009~~ 2012 International Building Code, published by the International Code Council, Inc. Any codes and standards referenced in the IBC are also considered to be part of the incorporation by reference, except that such codes and standards are used only to the prescribed extent of each such reference. In addition, any provisions of the appendices of the IBC specifically identified to be part of the USBC are also considered to be part of the incorporation by reference.

Note 1: The IBC references ~~the whole family of other~~ International Codes and standards including the following major codes:

~~2009~~ 2012 International Plumbing Code (IPC)

~~2009~~ 2012 International Mechanical Code (IMC)

~~2008~~ 2011 NFPA 70

~~2009~~ 2012 International Fuel Gas Code (IFGC)

~~2009~~ 2012 International Energy Conservation Code (IECC)

~~2009~~ 2012 International Residential Code (IRC)

Note 2: The ~~International Residential Code~~ IRC is applicable to the construction of detached one- and two-family dwellings and townhouses as set out in Section 310.

C. Section 101.3 Numbering system. A dual numbering system is used in the USBC to correlate the numbering system of the Virginia Administrative Code with the numbering system of the IBC. IBC numbering system designations are provided in the catchlines of the Virginia Administrative Code sections. Cross references between sections or chapters of the USBC use only the IBC numbering system designations. The term "chapter" is used in the context of the numbering system of the IBC and may mean a chapter in the USBC, a chapter in the IBC or a chapter in a referenced code or standard, depending on the context of the use of the term. The term "chapter" is not used to designate a chapter of the Virginia Administrative Code, unless clearly indicated.

D. Section 101.4 Arrangement of code provisions. The USBC is comprised of the combination of (i) the provisions of Chapter 1, Administration, which are established herein, (ii) Chapters 2 - 35 of the IBC, which are incorporated by reference in Section 101.2, and (iii) the changes to the text of the incorporated chapters of the IBC that are specifically identified. The terminology "changes to the text of the incorporated chapters of the IBC that are specifically identified" shall also be referred to as the "state amendments to the IBC." Such state amendments to the IBC are set out using corresponding chapter and section numbers of the IBC numbering system. In addition, since Chapter 1 of the IBC is not incorporated as part of the USBC, any reference to a provision of Chapter 1 of the IBC in the provisions of Chapters 2 - 35 of the IBC is generally invalid. However, where the purpose of such a reference would clearly correspond to a provision of Chapter 1 established herein, then the reference may be construed to be a valid reference to such corresponding Chapter 1 provision.

E. Section 101.5 Use of terminology and notes. The term "this code," or "the code," where used in the provisions of Chapter 1, in Chapters 2 - 35 of the IBC or in the state amendments to the IBC means the USBC, unless the context clearly indicates otherwise. The term "this code" or "the code" where used in a code or standard referenced in the IBC means that code or standard, unless the context clearly indicates otherwise. The use of notes in Chapter 1 is to provide information only and shall not be construed as changing the meaning of any code provision. Notes in the IBC, in the codes and standards referenced in the IBC and in the state amendments to the IBC may modify the content of a related provision and shall be considered to be a valid part of the provision, unless the context clearly indicates otherwise.

F. Section 101.6 Order of precedence. The provisions of this code shall be used as follows:

1. The provisions of Chapter 1 of this code supersede any ~~conflicting~~ provisions of Chapters 2 - 35 of the IBC and

that address the same subject matter and impose differing requirements.

2. The provisions of Chapter 1 of this code supersede any ~~conflicting~~ provisions of the codes and standards referenced in the IBC that address the same subject matter and impose differing requirements. In addition, the

3. The state amendments to the IBC supersede any ~~conflicting~~ provisions of Chapters 2 - 35 of the IBC and that address the same subject matter and impose differing requirements.

4. The state amendments to the IBC supersede any ~~conflicting~~ provisions of the codes and standards referenced in the IBC that address the same subject matter and impose differing requirements. Further, the

5. The provisions of Chapters 2 - 35 of the IBC supersede any ~~conflicting~~ provisions of the codes and standards referenced in the IBC that address the same subject matter and impose differing requirements.

G. Section 101.7 Administrative provisions. The provisions of Chapter 1 establish administrative requirements, which include but are not limited to provisions relating to the scope of the code, enforcement, fees, permits, inspections and disputes. Any provisions of Chapters 2 - 35 of the IBC or any provisions of the codes and standards referenced in the IBC that address the same subject matter and impose differing requirements are deleted and replaced by the provisions of Chapter 1. Further, any administrative requirements contained in the state amendments to the IBC shall be given the same precedence as the provisions of Chapter 1. Notwithstanding the above, where administrative requirements of Chapters 2 - 35 of the IBC or of the codes and standards referenced in the IBC are specifically identified as valid administrative requirements in Chapter 1 of this code or in the state amendments to the IBC, then such requirements are not deleted and replaced.

Note: The purpose of this provision is to eliminate overlap, conflicts and duplication by providing a single standard for administrative, procedural and enforcement requirements of this code.

H. Section 101.8 Definitions. The definitions of terms used in this code are contained in Chapter 2 along with specific provisions addressing the use of definitions. Terms may be defined in other chapters or provisions of the code and such definitions are also valid.

Note: The order of precedence outlined in Section 101.6 may be determinative in establishing how to apply the definitions in the IBC and in the referenced codes and standards.

13VAC5-63-20. Section 102 Purpose and scope.

A. Section 102.1 Purpose. In accordance with § 36-99 of the Code of Virginia, the purpose of the USBC is to protect the health, safety and welfare of the residents of the Commonwealth of Virginia, provided that buildings and

Regulations

structures should be permitted to be constructed at the least possible cost consistent with recognized standards of health, safety, energy conservation and water conservation, including provisions necessary to prevent overcrowding, rodent or insect infestation, and garbage accumulation; and barrier-free provisions for the physically handicapped and aged.

B. Section 102.2 Scope. This section establishes the scope of the USBC in accordance with § 36-98 of the Code of Virginia. The USBC shall supersede the building codes and regulations of the counties, municipalities and other political subdivisions and state agencies. This code also shall supersede the provisions of local ordinances applicable to single-family residential construction that (i) regulate dwelling foundations or crawl spaces, (ii) require the use of specific building materials or finishes in construction, or (iii) require minimum surface area or numbers of windows; however, this code shall not supersede proffered conditions accepted as a part of a rezoning application, conditions imposed upon the grant of special exceptions, special or conditional use permits or variances, conditions imposed upon a clustering of single-family homes and preservation of open space development through standards, conditions, and criteria established by a locality pursuant to subdivision 8 of § 15.2-2242 of the Code of Virginia or subdivision A 12 of § 15.2-2286 of the Code of Virginia, or land use requirements in airport or highway overlay districts, or historic districts created pursuant to § 15.2-2306 of the Code of Virginia, or local flood plain regulations adopted as a condition of participation in the National Flood Insurance Program.

Note: Requirements relating to functional design are contained in Section 103.11 of this code.

C. Section 102.2.1 Invalidity of provisions. To the extent that any provisions of this code are in conflict with Chapter 6 (§ 36-97 et seq.) of Title 36 of the Code of Virginia or in conflict with the scope of the USBC, those provisions are considered to be invalid to the extent of such conflict.

D. Section 102.3 Exemptions. The following are exempt from this code:

1. Equipment, related wiring, and poles and towers supporting the related wiring installed by a provider of publicly regulated utility service or a franchised cable television operator and electrical equipment and related wiring used for radio, broadcast or cable television, telecommunications or information service transmission. The exemption shall apply only if under applicable federal and state law the ownership and control of the equipment and wiring is by the service provider or its affiliates. Such exempt equipment and wiring shall be located on either rights-of-way or property for which the service provider has rights of occupancy and entry; however, the structures, including their service equipment, housing or supporting such exempt equipment and wiring shall be subject to the USBC. The installation of equipment and wiring exempted

by this section shall not create an unsafe condition prohibited by the USBC.

2. Manufacturing and processing machines that do not produce or process hazardous materials regulated by this code, including all of the following service equipment associated with the manufacturing or processing machines.

- 2.1. Electrical equipment connected after the last disconnecting means.

- 2.2. Plumbing piping and equipment connected after the last shutoff valve or backflow device and before the equipment drain trap.

- 2.3. Gas piping and equipment connected after the outlet shutoff valve.

Manufacturing and processing machines that produce or process hazardous materials regulated by this code are only required to comply with the code provisions regulating the hazardous materials.

3. Parking lots and sidewalks, ~~which~~ that are not part of an accessible route.

4. Nonmechanized playground or recreational equipment such as swing sets, sliding boards, climbing bars, jungle gyms, skateboard ramps, and similar equipment where no admission fee is charged for its use or for admittance to areas where the equipment is located.

5. Industrialized buildings subject to the Virginia Industrialized Building Safety Regulations (13VAC5-91) and manufactured homes subject to the Virginia Manufactured Home Safety Regulations (13VAC5-95); except as provided for in Section ~~424~~ 425.

6. Farm buildings and structures, except for a building or a portion of a building located on a farm that is operated as a restaurant as defined in § 35.1-1 of the Code of Virginia and licensed as such by the Virginia Board of Health pursuant to Chapter 2 (§ 35.1-11 et seq.) of Title 35.1 of the Code of Virginia. However, farm buildings and structures lying within a flood plain or in a mudslide-prone area shall be subject to flood-proofing regulations or mudslide regulations, as applicable.

7. Federally owned buildings and structures unless federal law specifically requires a permit from the locality. Underground storage tank installations, modifications and removals shall comply with this code in accordance with federal law.

8. Off-site manufactured intermodal freight containers, moving containers, and storage containers placed on site temporarily or permanently for use as a storage container.

9. Automotive lifts.

13VAC5-63-30. Section 103 Application of code.

- A. Section 103.1 General. In accordance with § 36-99 of the Code of Virginia, the USBC shall prescribe building regulations to be complied with in the construction and

rehabilitation of buildings and structures, and the equipment therein.

B. Section 103.2 When applicable to new construction. Construction for which a permit application is submitted to the local building department on or after the effective date of the ~~2009~~ 2012 edition of the code shall comply with the provisions of this code, except for permit applications submitted during a one-year period ~~after beginning on~~ the effective date of the 2009 2012 edition of the code. The applicant for a permit during such one-year period shall be permitted to choose whether to comply with the provisions of this code or the provisions of the edition of the code in effect immediately prior to the ~~2009 2012~~ edition. This provision shall also apply to subsequent amendments to this code based on the effective date of such amendments. In addition, when a permit has been properly issued under a previous edition of this code, this code shall not require changes to the approved construction documents, design or construction of such a building or structure, provided the permit has not been suspended or revoked.

C. Section 103.3 Change of occupancy. No change of occupancy shall be made in any structure when the current USBC requires a greater degree of accessibility, structural strength, fire protection, means of egress, ventilation or sanitation. When such a greater degree is required, the owner or the owner's agent shall make comply with the following:

1. When involving Group I-2 or I-3, written application shall be made to the local building department for a new certificate of occupancy and ~~shall obtain~~ the new certificate of occupancy shall be obtained prior to the new use of the structure. When impractical to achieve compliance with this code for the new occupancy classification, the building official shall consider modifications upon application and as provided for in Section 106.3. In addition, the applicable accessibility provisions of Section 1012.8 of Part II of the Virginia Uniform Statewide Building Code, also known as the "Virginia Rehabilitation Code," or the "VRC" shall be met.

Exception: This section shall not be construed to permit noncompliance with any applicable flood load or flood-resistant construction requirements of this code.

2. In other than Group I-2 or I-3, the provisions of the VRC for change of occupancy shall be met.

D. Section 103.4 Additions. Additions to buildings and structures shall comply with the requirements of this code for new construction ~~and an~~ or shall comply with the VRC. An existing building or structure plus additions shall comply with the height and area provisions of Chapter 5 and the applicable provisions of Chapter 9. Further, this code shall not require changes to the design or construction of any portions of the building or structure not altered or affected by an addition, unless the addition has the effect of lowering the current level of safety.

Exception Exceptions:

1. This section shall not be construed to permit noncompliance with any applicable flood load or flood-resistant construction requirements of this code.

2. When this code is used for compliance, existing structural elements carrying gravity loads shall be permitted to comply with Section 1103 of the International Existing Building Code.

E. Section 103.5 Reconstruction, alteration or repair in Group R-5 occupancies. The following criteria is applicable to reconstruction, alteration or repair of Group R-5 buildings or structures:

1. Any reconstruction, alteration or repair shall not adversely affect the performance of the building or structure, or cause the building or structure to become unsafe or lower existing levels of health and safety.

2. Parts of the building or structure not being reconstructed, altered or repaired shall not be required to comply with the requirements of this code applicable to newly constructed buildings or structures.

3. The installation of material or equipment, or both, that is neither required nor prohibited shall only be required to comply with the provisions of this code relating to the safe installation of such material or equipment.

4. Material or equipment, or both, may be replaced in the same location with material or equipment of a similar kind or capacity.

Exceptions:

1. This section shall not be construed to permit noncompliance with any applicable flood load or flood-resistant construction requirements of this code.

2. Reconstructed decks, balconies, porches and similar structures located 30 inches (762 mm) or more above grade shall meet the current code provisions for structural loading capacity, connections and structural attachment. This requirement excludes the configuration and height of handrails and guardrails.

3. Compliance with the VRC shall be an acceptable alternative to compliance with this section at the discretion of the owner or owner's agent.

F. Section 103.5.1 Equipment changes. Upon the replacement or new installation of any fuel-burning appliances or equipment in existing Group R-5 occupancies, an inspection or inspections shall be conducted to ensure that the connected vent or chimney systems comply with the following:

1. Vent or chimney systems are sized in accordance with the IRC.

2. Vent or chimney systems are clean, free of any obstruction or blockages, defects, or deterioration, and are in operable condition. Where not inspected by the local building department, persons performing such changes or

Regulations

installations shall certify to the building official that the requirements of Items 1 and 2 of this section are met.

~~F. G. Section 103.6. Use of rehabilitation code Reconstruction, alteration, and repair in other occupancies. Compliance with Part II of the Virginia Uniform Statewide Building Code, also known as the "Virginia Rehabilitation Code," shall be an acceptable alternative to compliance with this code for the rehabilitation of such existing buildings and structures within the scope of that code. For the purposes of this section, the term "rehabilitation" shall be as defined in the Virginia Rehabilitation Code Reconstruction, alteration, and repair in occupancies other than Group R-5 shall comply with the VRC.~~

~~G. H. Section 103.7. Retrofit requirements. The local building department shall enforce the provisions of Section 3413 1701 of the VRC, which require certain existing buildings to be retrofitted with fire protection systems and other safety equipment. Retroactive fire protection system requirements contained in the International Fire Code (IFC) shall not be applicable unless required for compliance with the provisions of Section 3413 1701 of the VRC.~~

~~H. I. Section 103.8 Nonrequired equipment. The following criteria for nonrequired equipment is in accordance with § 36-103 of the Code of Virginia. Building owners may elect to install partial or full fire alarms or other safety equipment that was not required by the edition of the USBC in effect at the time a building was constructed without meeting current requirements of the code, provided the installation does not create a hazardous condition. Permits for installation shall be obtained in accordance with this code. In addition, as a requirement of this code, when such nonrequired equipment is to be installed, the building official shall notify the appropriate fire official or fire chief.~~

~~I. J. Section 103.8.1 Reduction in function or discontinuance of nonrequired fire protection systems. When a nonrequired fire protection system is to be reduced in function or discontinued, it shall be done in such a manner so as not to create a false sense of protection. Generally, in such cases, any features visible from interior areas shall be removed, such as sprinkler heads, smoke detectors or alarm panels or devices, but any wiring or piping hidden within the construction of the building may remain. Approval of the proposed method of reduction or discontinuance shall be obtained from the building official.~~

~~J. Section 103.9 Equipment changes. Upon the replacement or new installation of any fuel burning appliances or equipment in existing buildings, an inspection or inspections shall be conducted to ensure that the connected vent or chimney systems comply with the following:~~

~~1. Vent or chimney systems are sized in accordance with either the International Residential Code, the International Mechanical Code or the International Fuel Gas Code, depending on which is applicable based on the fuel source and the occupancy classification of the structure.~~

~~2. Vent or chimney systems are clean, free of any obstruction or blockages, defects or deterioration and are in operable condition.~~

~~Where not inspected by the local building department, persons performing such changes or installations shall certify to the building official that the requirements of Items 1 and 2 of this section are met.~~

~~K. Section 103.10 103.8 Use of certain provisions of referenced codes. The following provisions of the IBC and of other indicated codes or standards are to be considered valid provisions of this code. Where any such provisions have been modified by the state amendments to the IBC, then the modified provisions apply.~~

~~1. Special inspection requirements in Chapters 2 - 35.~~

~~2. Chapter 34, Existing Structures, except that Section 3412, Compliance Alternatives, shall not be used to comply with the retrofit requirements identified in Section 103.7 and shall not be construed to permit noncompliance with any applicable flood load or flood resistant construction requirements of this code.~~

~~3. 2. Testing requirements and requirements for the submittal of construction documents in any of the ICC codes referenced in Chapter 35 and in the IRC.~~

~~4. 3. Section R301.2 of the International Residential Code IRC authorizing localities to determine climatic and geographic design criteria.~~

~~5. 4. Flood load or flood-resistant construction requirements in the IBC or the International Residential Code IRC, including, but not limited to, any such provisions pertaining to flood elevation certificates that are located in Chapter 1 of those codes. Any required flood elevation certificate pursuant to such provisions shall be prepared by a land surveyor licensed in Virginia or an RDP.~~

~~6. 5. Section R101.2 of the IRC.~~

~~L. Section 103.11 Functional design. The following criteria for functional design is in accordance with § 36-98 of the Code of Virginia. The USBC shall not supersede the regulations of other state agencies that require and govern the functional design and operation of building related activities not covered by the USBC, including but not limited to (i) public water supply systems, (ii) waste water treatment and disposal systems, and (iii) solid waste facilities, nor. Nor shall state agencies be prohibited from requiring, pursuant to other state law, that buildings and equipment be maintained in accordance with provisions of this code. In addition, as established by this code, the building official may refuse to issue a permit until the applicant has supplied certificates of functional design approval from the appropriate state agency or agencies. For purposes of coordination, the locality may require reports to the building official by other departments or agencies indicating compliance with their regulations applicable to the functional design of a building or structure~~

as a condition for issuance of a building permit or certificate of occupancy. Such reports shall be based upon review of the plans or inspection of the project as determined by the locality. All enforcement of these conditions shall not be the responsibility of the building official, but rather the agency imposing the condition.

Note: Identified state agencies with functional design approval are listed in the "Related Laws Package," which is available from DHCD.

M. Section 103.12 Amusement devices and inspections. In accordance with § 36-98.3 of the Code of Virginia, to the extent they are not superseded by the provisions of § 36-98.3 of the Code of Virginia and the VADR, the provisions of the USBC shall apply to amusement devices. In addition, as a requirement of this code, inspections for compliance with the VADR shall be conducted either by local building department personnel or private inspectors provided such persons are certified as amusement device inspectors under the VCS.

N. Section 103.13 State buildings and structures. This section establishes the application of the USBC to state-owned buildings and structures in accordance with § 36-98.1 of the Code of Virginia. The USBC shall be applicable to all state-owned buildings and structures, with the exception that §§ 2.2-1159, 2.2-1160 and 2.2-1161 of the Code of Virginia shall provide the standards for ready access to and use of state-owned buildings by the physically handicapped.

Any state-owned building or structure for which preliminary plans were prepared or on which construction commenced after the initial effective date of the USBC, shall remain subject to the provisions of the USBC that were in effect at the time such plans were completed or such construction commenced. Subsequent reconstruction, renovation or demolition of such building or structure shall be subject to the pertinent provisions of this code.

Acting through the Division of Engineering and Buildings, the Virginia Department of General Services shall function as the building official for state-owned buildings. The department shall review and approve plans and specifications, grant modifications, and establish such rules and regulations as may be necessary to implement this section. It shall provide for the inspection of state-owned buildings and enforcement of the USBC and standards for access by the physically handicapped by delegating inspection and USBC enforcement duties to the State Fire Marshal's Office, to other appropriate state agencies having needed expertise, and to local building departments, all of which shall provide such assistance within a reasonable time and in the manner requested. State agencies and institutions occupying buildings shall pay to the local building department the same fees as would be paid by a private citizen for the services rendered when such services are requested by the department. The department may alter or overrule any decision of the local building department after having first considered the local building department's report or other rationale given for its

decision. When altering or overruling any decision of a local building department, the department shall provide the local building department with a written summary of its reasons for doing so.

Notwithstanding any provision of this code to the contrary, roadway tunnels and bridges owned by the Virginia Department of Transportation shall be exempt from this code. The Virginia Department of General Services shall not have jurisdiction over such roadway tunnels, bridges and other limited access highways; provided, however, that the Department of General Services shall have jurisdiction over any occupied buildings within any Department of Transportation rights-of-way that are subject to this code.

Except as provided in subdivision D of § 23-38.109 ~~D~~ of the Code of Virginia, and notwithstanding any provision of this code to the contrary, at the request of a public institution of higher education, the Virginia Department of General Services, as further set forth in this provision, shall authorize that institution of higher education to contract with a building official of the locality in which the construction is taking place to perform any inspection and certifications required for the purpose of complying with this code. The department shall publish administrative procedures that shall be followed in contracting with a building official of the locality. The authority granted to a public institution of higher education under this provision to contract with a building official of the locality shall be subject to the institution meeting the conditions prescribed in subdivision B of § 23-38.88 ~~B~~ of the Code of Virginia.

Note: In accordance with § 36-98.1 of the Code of Virginia, roadway tunnels and bridges shall be designed, constructed and operated to comply with fire safety standards based on nationally recognized model codes and standards to be developed by the Virginia Department of Transportation in consultation with the State Fire Marshal and approved by the Virginia Commonwealth Transportation Board. Emergency response planning and activities related to the standards approved by the Commonwealth Transportation Board shall be developed by the Department of Transportation and coordinated with the appropriate local officials and emergency service providers. On an annual basis, the Department of Transportation shall provide a report on the maintenance and operability of installed fire protection and detection systems in roadway tunnels and bridges to the State Fire Marshal.

O. Section 103.13.1 Certification of state enforcement personnel. State enforcement personnel shall comply with the applicable requirements of Section 105 for certification, periodic maintenance training, and continuing education.

13VAC5-63-40. Section 104 Enforcement, generally.

A. Section 104.1 Scope of enforcement. This section establishes the requirements for enforcement of the USBC in accordance with § 36-105 of the Code of Virginia. Enforcement of the provisions of the USBC for construction

Regulations

and rehabilitation shall be the responsibility of the local building department. Whenever a county or municipality does not have such a building department, the local governing body shall enter into an agreement with the local governing body of another county or municipality or with some other agency, or a state agency approved by DHCD for such enforcement. For the purposes of this section, towns with a population of less than 3,500 may elect to administer and enforce the USBC; however, where the town does not elect to administer and enforce the code, the county in which the town is situated shall administer and enforce the code for the town. In the event such town is situated in two or more counties, those counties shall administer and enforce the USBC for that portion of the town situated within their respective boundaries.

~~Upon~~ However, upon a finding by the local building department, following a complaint by a tenant of a residential ~~rental dwelling~~ unit that is the subject of such complaint, that there may be a violation of the unsafe structures provisions of Part III of the Virginia Uniform Statewide Building Code, also known as the "Virginia Maintenance Code," or the "VMC," the local building department shall enforce such provisions.

If the local building department receives a complaint that a violation of the ~~Virginia Maintenance Code VMC~~ exists that is an immediate and imminent threat to the health or safety of the owner ~~or, tenant, or occupants~~ of a residential dwelling unit or a nearby residential dwelling unit, and any building or structure, or the owner, occupant, or tenant or any nearby building or structure, and the owner, occupant, or tenant of the residential dwelling unit ~~building or structure~~ that is the subject of the complaint has refused to allow the local building official or his agent to have access to the subject ~~dwelling building or structure~~, the local building official or his agent may present sworn testimony to a magistrate or court of competent jurisdiction and request that the magistrate or court grant the local building official or his agent an inspection warrant to enable the building official or his agent to enter the subject ~~dwelling building or structure~~ for the purpose of determining whether violations of the ~~Virginia Maintenance Code VMC~~ exist. The local building official or his agent shall make a reasonable effort to obtain consent from the owner, occupant, or tenant of the subject ~~dwelling building or structure~~ prior to seeking the issuance of an inspection warrant under this section.

The local governing body shall, however, inspect and enforce the provisions of the ~~Virginia Maintenance Code VMC~~ for elevators, escalators, and related conveyances, except for elevators in single-family and two-family homes and townhouses. Such inspection and enforcement shall be carried out by an agency or department designated by the local governing body.

B. Section 104.2 Interagency coordination. When any inspection functions under this code are assigned to a local

agency other than the local building department, such agency shall coordinate its reports of inspection with the local building department.

~~C. 104.3 Transfer of ownership. If the local building department has initiated an enforcement action against the owner of a building or structure and such owner subsequently transfers the ownership of the building or structure to an entity in which the owner holds an ownership interest greater than 50%, the pending enforcement action shall continue to be enforced against the owner.~~

13VAC5-63-80. Section 108 Application for permit.

A. Section 108.1 When applications are required. Application for a permit shall be made to the building official and a permit shall be obtained prior to the commencement of any of the following activities, except that applications for emergency construction, alterations or equipment replacement shall be submitted by the end of the first working day that follows the day such work commences. In addition, the building official may authorize work to commence pending the receipt of an application or the issuance of a permit.

1. Construction or demolition of a building or structure. Installations or alterations involving (i) the removal or addition of any wall, partition or portion thereof, (ii) any structural component, (iii) the repair or replacement of any required component of a fire or smoke rated assembly, (iv) the alteration of any required means of egress system, (v) water supply and distribution system, sanitary drainage system or vent system, (vi) electric wiring, (vii) fire protection system, mechanical systems, or fuel supply systems, or (viii) any equipment regulated by the USBC.
2. For change of occupancy, application for a permit shall be made when a new certificate of occupancy is required under Section 103.3.
3. Movement of a lot line that increases the hazard to or decreases the level of safety of an existing building or structure in comparison to the building code under which such building or structure was constructed.
4. Removal or disturbing of any asbestos containing materials during the construction or demolition of a building or structure, including additions.

B. Section 108.2 Exemptions from application for permit. Notwithstanding the requirements of Section 108.1, application for a permit and any related inspections shall not be required for the following; however, this section shall not be construed to exempt such activities from other applicable requirements of this code. In addition, when an owner or an owner's agent requests that a permit be issued for any of the following, then a permit shall be issued and any related inspections shall be required.

1. Installation of wiring and equipment that (i) operates at less than 50 volts, (ii) is for network powered broadband communications systems, or (iii) is exempt under Section

102.3(1), except when any such installations are located in a plenum, penetrate fire rated or smoke protected construction or are a component of any of the following:

- 1.1. Fire alarm system.
 - 1.2. Fire detection system.
 - 1.3. Fire suppression system.
 - 1.4. Smoke control system.
 - 1.5. Fire protection supervisory system.
 - 1.6. Elevator fire safety control system.
 - 1.7. Access or egress control system or delayed egress locking or latching system.
 - 1.8. Fire damper.
 - 1.9. Door control system.
2. One story detached ~~accessory~~ structures used as tool and storage sheds, playhouses or similar uses, provided the ~~floor~~ building area does not exceed ~~200~~ 256 square feet (~~18 m²~~ (23.78 m²) and the structures are not classified as a Group F-1 or H occupancy.
 3. Detached prefabricated buildings housing the equipment of a publicly regulated utility service, provided the floor area does not exceed 150 square feet (14 m²).
 4. Tents or air-supported structures, or both, that cover an area of 900 square feet (84 m²) or less, including within that area all connecting areas or spaces with a common means of egress or entrance, provided such tents or structures have an occupant load of 50 or less persons.
 5. Fences ~~and privacy walls not part of a building, structure or~~ of any height unless required for pedestrian safety as provided for by Section 3306, or used for the barrier for a swimming pool.
 6. Concrete or masonry walls, provided such ~~fences and~~ privacy walls do not exceed six feet in height above the finished grade. Ornamental ~~post~~ column caps shall not be considered to contribute to the height of the ~~fence or~~ privacy wall and shall be permitted to extend above the six feet height measurement.
 7. ~~7.~~ 8. Retaining walls supporting less than ~~two~~ three feet of unbalanced fill. ~~This exemption shall not apply to any wall that are not constructed for the purpose of impounding Class I, II or III-A liquids or supporting a surcharge other than ordinary unbalanced fill.~~
 7. ~~8.~~ 8. Swimming pools that have a surface area not greater than 150 square feet (13.95 m²), do not exceed 5,000 gallons (19 000 L) and are less than 24 inches (610 mm) deep.
 8. ~~9.~~ 9. Signs under the conditions in Section H101.2 of Appendix H.
 9. ~~10.~~ 10. Replacement of above-ground existing LP-gas containers of the same capacity in the same location and associated regulators when installed by the serving gas supplier.

~~10.~~ 11. Ordinary repairs that include the following:

- ~~10.1.~~ 11.1. Replacement of windows and doors with windows and doors of similar operation and opening dimensions that do not require changes to the existing framed opening and that are not required to be fire rated in Group R-2 where serving a single dwelling unit and in Groups R-3, R-4 and R-5.
 - ~~10.2.~~ 11.2. Replacement of plumbing fixtures and well pumps in all groups without alteration of the water supply and distribution systems, sanitary drainage systems or vent systems.
 - ~~10.3.~~ 11.3. Replacement of general use snap switches, dimmer and control switches, 125 volt-15 or 20 ampere receptacles, luminaries (lighting fixtures) and ceiling (paddle) fans in Group R-2 where serving a single dwelling unit and in Groups R-3, R-4 and R-5.
 - ~~10.4.~~ 11.4. Replacement of mechanical appliances provided such equipment is not fueled by gas or oil in Group R-2 where serving a single family dwelling and in Groups R-3, R-4 and R-5.
 - ~~10.5.~~ 11.5. Replacement of an unlimited amount of roof covering or siding in Groups R-3, R-4 or R-5 provided the building or structure is not in an area where the design (3 second gust) wind speed is greater than 100 miles per hour (160 km/hr) and replacement of 100 square feet (9.29 m²) or less of roof covering in all groups and all wind zones.
 - ~~10.6.~~ 11.6. Replacement of 100 square feet (9.29 m²) or less of roof decking in Groups R-3, R-4 or R-5 unless the decking to be replaced was required at the time or original construction to be fire-retardant-treated or protected in some other way to form a fire-rated wall termination.
 - ~~10.7.~~ 11.7. Installation or replacement of floor finishes in all occupancies.
 - ~~10.8.~~ 11.8. Replacement of Class C interior wall or ceiling finishes installed in Groups A, E and I and replacement of all classes of interior wall or ceiling finishes in other groups.
 - ~~10.9.~~ 11.9. Installation ~~of~~ or replacement of cabinetry or trim.
 - ~~10.10.~~ 11.10 Application of paint or wallpaper.
 - ~~10.11.~~ 11.11. Other repair work deemed by the building official to be minor and ordinary which does not adversely affect public health or general safety.
12. Crypts, mausoleums, and columbaria structures not exceeding 1500 square feet (139.35 m²) in area if the building or structure is not for occupancy and used solely for the interment of human or animal remains and is not subject to special inspections.

Exception: Application for a permit may be required by the building official for the installation of replacement siding,

Regulations

roofing and windows in buildings within a historic district designated by a locality pursuant to § 15.2-2306 of the Code of Virginia.

C. Section 108.3 Applicant information, processing by mail. Application for a permit shall be made by the owner or lessee of the relevant property or the agent of either or by the RDP, contractor or subcontractor associated with the work or any of their agents. The full name and address of the owner, lessee and applicant shall be provided in the application. If the owner or lessee is a corporate body, when and to the extent determined necessary by the building official, the full name and address of the responsible officers shall also be provided.

A permit application may be submitted by mail and such permit applications shall be processed by mail, unless the permit applicant voluntarily chooses otherwise. In no case shall an applicant be required to appear in person.

The building official may accept applications for a permit through electronic submissions provided the information required by this section is obtained.

D. Section 108.4 Prerequisites to obtaining permit. In accordance with § 54.1-1111 of the Code of Virginia, any person applying to the building department for the construction, removal or improvement of any structure shall furnish prior to the issuance of the permit either (i) satisfactory proof to the building official that he is duly licensed or certified under the terms of Chapter 11 (§ 54.1-1000 et seq.) of Title 54.1 of the Code of Virginia to carry out or superintend the same or (ii) file a written statement, supported by an affidavit, that he is not subject to licensure or certification as a contractor or subcontractor pursuant to Chapter 11 of Title 54.1 of the Code of Virginia. The applicant shall also furnish satisfactory proof that the taxes or license fees required by any county, city, or town have been paid so as to be qualified to bid upon or contract for the work for which the permit has been applied.

E. Section 108.5 Mechanics' lien agent designation. In accordance with § 36-98.01 of the Code of Virginia, a building permit issued for any one-family or two-family residential dwelling shall at the time of issuance contain, at the request of the applicant, the name, mailing address, and telephone number of the mechanics' lien agent as defined in § 43-1 of the Code of Virginia. If the designation of a mechanics' lien agent is not so requested by the applicant, the building permit shall at the time of issuance state that none has been designated with the words "None Designated."

Note: In accordance with § 43-4.01A of the Code of Virginia, a permit may be amended after it has been initially issued to name a mechanics' lien agent or a new mechanics' lien agent.

F. Section 108.6 Application form, description of work. The application for a permit shall be submitted on a form or forms supplied by the local building department. The application shall contain a general description and location of the

proposed work and such other information as determined necessary by the building official.

G. Section 108.7 Amendments to application. An application for a permit may be amended at any time prior to the completion of the work governed by the permit. Additional construction documents or other records may also be submitted in a like manner. All such submittals shall have the same effect as if filed with the original application for a permit and shall be retained in a like manner as the original filings.

H. Section 108.8 Time limitation of application. An application for a permit for any proposed work shall be deemed to have been abandoned six months after the date of filing unless such application has been pursued in good faith or a permit has been issued, except that the building official is authorized to grant one or more extensions of time if a justifiable cause is demonstrated.

13VAC5-63-110. Section 111 RDP services.

A. Section 111.1 When required. In accordance with § 54.1-410 of the Code of Virginia and under the general authority of this code, the local building department shall establish a procedure to ensure that construction documents under Section 109 are prepared by an RDP in any case in which the exemptions contained in § 54.1-401, 54.1-402 or 54.1-402.1 of the Code of Virginia are not applicable or in any case where the building official determines it necessary. When required under § 54.1-402 of the Code of Virginia or when required by the building official, or both, construction documents shall bear the name and address of the author and his occupation.

Note: Information on the types of construction required to be designed by an RDP is included in the "Related Laws Package" available from DHCD.

B. Section 111.2 Special inspection requirements. Special inspections shall be conducted when required by Section 1704. Individuals or agencies, or both, conducting special inspections shall meet the qualification requirements of Sections 1703 and ~~1704.1~~ 1704.2.1. The permit applicant shall submit a completed statement of special inspections with the permit application. The building official shall review, and if satisfied that the requirements have been met, approve the statement of special inspections as required in Sections ~~1704.1.1~~ 1704.2.3 and 1705 as a requisite to the issuance of a building permit. The building official may require interim inspection reports. The building official shall receive, and if satisfied that the requirements have been met, approve a final report of special inspections as specified in Section ~~1704.1.2~~ 1704.2.4. All fees and costs related to the special inspections shall be the responsibility of the building owner.

13VAC5-63-120. Section 112 Workmanship, materials and equipment.

A. Section 112.1 General. It shall be the duty of any person performing work covered by this code to comply with all applicable provisions of this code and to perform and complete such work so as to secure the results intended by the USBC. Damage to regulated building components caused by violations of this code or by the use of faulty materials or installations shall be considered as separate violations of this code and shall be subject to the applicable provisions of Section 115.

B. Section 112.2 Alternative methods or materials. In accordance with § 36-99 of the Code of Virginia, where practical, the provisions of this code are stated in terms of required level of performance so as to facilitate the prompt acceptance of new building materials and methods. When generally recognized standards of performance are not available, this section and other applicable requirements of this code provide for acceptance of materials and methods whose performance is substantially equal in safety to those specified on the basis of reliable test and evaluation data presented by the proponent. In addition, as a requirement of this code, the building official shall require that sufficient technical data be submitted to substantiate the proposed use of any material, equipment, device, assembly or method of construction.

C. Section 112.3 Documentation and approval. In determining whether any material, equipment, device, assembly or method of construction complies with this code, the building official shall approve items listed by nationally recognized testing laboratories (NRTL), when such items are listed for the intended use and application, and in addition, may consider the recommendations of RDPs. Approval shall be issued when the building official finds that the proposed design is satisfactory and complies with the intent of the provisions of this code and that the material, equipment, device, assembly or method of construction offered is, for the purpose intended, at least the equivalent of that prescribed by the code. Such approval is subject to all applicable requirements of this code and the material, equipment, device, assembly or method of construction shall be installed in accordance with the conditions of the approval and their listings. In addition, the building official may revoke such approval whenever it is discovered that such approval was issued in error or on the basis of incorrect information, or where there are repeated violations of the USBC.

D. Section 112.3.1 Conditions of listings. Where conflicts between this code and conditions of the listing or the manufacturer's installation instructions occur, the provisions of this code shall apply.

Exception: Where a code provision is less restrictive than the conditions of the listing of the equipment or appliance or the manufacturer's installation instructions, the conditions of

the listing and the manufacturer's installation instructions shall apply.

E. Section 112.4 Used material and equipment. Used materials, equipment and devices may be approved provided they have been reconditioned, tested or examined and found to be in good and proper working condition and acceptable for use by the building official.

~~F. Section 112.5 Defective materials. Notwithstanding any provision of this code to the contrary, where action has been taken and completed by the BHCD under § 36-99 D of the Code of Virginia establishing new performance standards for identified defective materials, this section sets forth the new performance standards addressing the prospective use of such materials and establishes remediation standards for the removal of any defective materials already installed, which, when complied with, enables the building official to certify that the building is deemed to comply with the edition of the USBC under which the building was originally constructed with respect to the remediation of the defective materials. Subsections F through X of this section expire on August 29, 2013.~~

~~G. Section 112.5.1 Drywall, performance standard. All newly installed gypsum wallboard shall not be defective drywall as defined in Section 112.5.1.1.1.~~

~~H. Section 112.5.1.1 Remediation standards. The following provisions establish remediation standards where defective drywall was installed in buildings.~~

~~I. Section 112.5.1.1.1 Definition. For the purposes of this section the term "defective drywall" shall mean gypsum wallboard that (i) contains elemental sulfur exceeding 10 parts per million that when exposed to heat or humidity, or both, emits volatile sulfur compounds in quantities that cause observable corrosion on electrical wiring, plumbing pipes, fuel gas lines, or HVAC equipment, or any components of the foregoing or (ii) has been designated by the U.S. Consumer Product Safety Commission as a product with a product defect that constitutes a substantial product hazard within the meaning of § 15(a)(2) of the Consumer Product Safety Act (15 USC § 2064(a)(2)).~~

~~J. Section 112.5.1.1.2 Permit. Application for a permit shall be made to the building official and a permit shall be obtained prior to the commencement of remediation work undertaken to remove defective drywall from a building and for the removal, replacement, or repair of corroded electrical, plumbing, mechanical, or fuel gas equipment and components.~~

~~K. Section 112.5.1.1.3 Protocol. Where remediation of defective drywall is undertaken, the following standards shall be met. The building official shall be permitted to consider and approve modifications to these standards in accordance with Section 106.3.~~

Regulations

~~L. Section 112.5.1.1.3.1 Drywall. Drywall in the building, whether defective or nondefective, shall be removed and discarded, including fasteners that held any defective drywall to prevent small pieces of drywall from remaining under fasteners.~~

~~Exceptions:~~

~~1. Nondefective drywall not subject to the corrosive effects of any defective drywall shall be permitted to be left in place in buildings where the defective drywall is limited to a defined room or space or isolated from the rest of the building and the defective drywall can be positively identified. If the room or space containing the defective drywall also contains any nondefective drywall, the nondefective drywall in that room or space shall also be removed.~~

~~2. In multi-family buildings where defective drywall was not used in the firewalls between units and there are no affected building systems behind the firewalls, the firewalls shall be permitted to be left in place.~~

~~M. Section 112.5.1.1.3.2 Insulation and other building components. Insulation in walls and ceilings shall be removed and discarded. Carpet and vinyl flooring shall be removed and discarded. Woodwork, trim, cabinets, and tile or wood floors may be left in place or may be reused.~~

~~Exceptions:~~

~~1. Closed cell foam insulation is permitted to be left in place if testing for off gassing from defective drywall is negative, unless its removal is required to gain access.~~

~~2. Insulation, carpet, or vinyl flooring in areas not exposed to defective drywall or to the effects of defective drywall, may be left in place or reused.~~

~~N. Section 112.5.1.1.3.3 Electrical wiring, equipment, devices, and components. All electrical wiring regulated by this code shall be permitted to be left in place, but removal or cleaning of exposed ends of the wiring to reveal clean or uncorroded surfaces is required. All electrical equipment, devices, and components of the electrical system of the building regulated by this code shall be removed and discarded. This shall include all smoke detectors.~~

~~Exceptions:~~

~~1. Electrical equipment, devices, or components in areas not exposed to the corrosive effects of defective drywall shall be permitted to be left in place or reused. Electrical equipment, devices, or components in areas exposed to the corrosive effects of defective drywall shall be cleaned, repaired, or replaced.~~

~~2. Cord and plug connected appliances are not subject to this code and, therefore, cannot be required to be removed or replaced.~~

~~Note: All low voltage wiring associated with security systems, door bells, elevator controls, and other such components shall be removed and replaced or repaired.~~

~~O. Section 112.5.1.1.3.4 Plumbing and fuel gas piping, fittings, fixtures, and equipment. All copper fuel gas piping and all equipment utilizing fuel gas with copper, silver, or aluminum components shall be removed and discarded. All copper plumbing pipes and fittings shall be removed and discarded. Plumbing fixtures with copper, silver, or aluminum components shall be removed and discarded.~~

~~Exception: Plumbing or fuel gas piping, fittings, fixtures, equipment, or components in areas not exposed to the corrosive effects of defective drywall shall be permitted to be left in place or reused.~~

~~P. Section 112.5.1.1.3.5 Mechanical systems. All heating, air conditioning, and ventilation system components, including, but not limited to, ductwork, air handling units, furnaces, heat pumps, refrigerant lines, and thermostats and associated wiring, shall be removed and discarded.~~

~~Exception: Mechanical system components in areas not exposed to the corrosive effects of defective drywall shall be permitted to be left in place or reused.~~

~~Q. Section 112.5.1.1.3.6 Cleaning. Following the removal of all materials and components in accordance with Sections 112.5.1.1.3.1 through 112.5.1.1.3.5, the building shall be thoroughly cleaned to remove any particulate matter and dust.~~

~~R. Section 112.5.1.1.3.7 Airing out. Following cleaning in accordance with Section 112.5.1.1.3.6, the building shall be thoroughly aired out with the use of open windows and doors and fans.~~

~~S. Section 112.5.1.1.3.8 Pre rebuilding clearance testing. Following the steps outlined above for removal of all materials and components, cleaning and airing out, a pre-rebuilding clearance test shall be conducted with the use of copper or silver coupons and the methodology outlined in the April 2, 2010, joint report by the Consumer Products Safety Commission and the Department of Housing and Urban Development entitled "Interim Remediation Guidance for Homes with Corrosion from Problem Drywall" or with the use of a copper probe and dosimeter. The clearance testing shall confirm that all airborne compounds associated with the defective drywall are at usual environmental background levels. The clearance testing report, certifying compliance, shall be submitted to the building official.~~

~~Notes:~~

~~1. Where the building is served by a well and prior to conducting clearance tests, all outlets in piping served by the well should be capped or otherwise plugged to prevent contamination of the air sample.~~

~~2. To prevent siphoning and evaporation of the trap seals, fixtures should be capped or otherwise plugged to prevent sewer gases from contaminating the air sample.~~

~~T. Section 112.5.1.1.3.9 Testing agencies and personnel. Agencies and personnel performing pre rebuilding or post-rebuilding clearance testing shall be independent of those responsible for all other remediation work and the agencies~~

and personnel shall be appropriately certified or accredited by the Council of Engineering and Scientific Specialty Boards, the American Indoor Air Quality Council, or the World Safety Organization.

Exception: Testing agencies and personnel shall be accepted if certified by an RDP or if the agency employs an RDP to be in responsible charge of the work.

~~U. Section 112.5.1.1.3.10 Rebuilding standards. The rebuilding of the building shall comply with the edition of the USBC that was in effect when the building was originally built.~~

~~V. Section 112.5.1.1.3.11 Post rebuilding clearance testing. A post rebuilding clearance test prior to reoccupancy of the building or structure shall be conducted with the use of copper or silver coupons and the methodology outlined in the April 2, 2010, joint report by the Consumer Products Safety Commission and by the Department of Housing and Urban Development entitled "Interim Remediation Guidance for Homes with Corrosion from Problem Drywall" or with the use of a copper probe and dosimeter. The clearance testing shall confirm that all airborne compounds associated with the defective drywall are at usual environmental background levels. The clearance testing report certifying compliance shall be submitted to the building official.~~

Notes:

1. Where the building is served by a well and prior to conducting clearance tests, all outlets in piping served by the well should be capped or otherwise plugged to prevent contamination of the air sample.

2. To prevent siphoning and evaporation of the trap seals, fixtures should be capped or otherwise plugged to prevent sewer gases from contaminating the air sample.

~~W. Section 112.5.1.1.4 Final approval by the building official. Once remediation has been completed in accordance with this section, a certificate or letter of approval shall be issued by the building official. The certificate or letter shall state that the remediation and rebuilding is deemed to comply with this code.~~

~~X. Section 112.5.1.1.4.1 Approval of remediation occurring prior to these standards. The building official shall issue a certificate or letter of approval for remediation of defective drywall that occurred prior to the effective date of these standards provided post rebuilding clearance testing has been performed in accordance with Section 112.5.1.1.3.11, by agencies and personnel complying with Section 112.5.1.1.3.9, and the clearance testing confirms that all airborne compounds associated with the defective drywall are at usual environmental background levels. The clearance testing report certifying compliance shall be submitted to the building official.~~

~~F. Section 112.5 Defective materials. Notwithstanding any provision of this code to the contrary, where action has been taken and completed by the BHCD under subsection D of~~

§ 36-99 of the Code of Virginia establishing new performance standards for identified defective materials, this section sets forth the new performance standards addressing the prospective use of such materials and establishes remediation standards for the removal of any defective materials already installed, which when complied with enables the building official to certify that the building is deemed to comply with the edition of the USBC under which the building was originally constructed with respect to the remediation of the defective materials.

G. Section 112.5.1 Drywall, performance standard. All newly installed gypsum wallboard shall not be defective drywall as defined in Section 112.5.1.1.1.

H. Section 112.5.1.1 Remediation standards. The following provisions establish remediation standards where defective drywall was installed in buildings.

I. Section 112.5.1.1.1 Definition. For the purposes of this section the term "defective drywall" means gypsum wallboard that (i) contains elemental sulfur exceeding 10 parts per million that when exposed to heat or humidity, or both, emits volatile sulfur compounds in quantities that cause observable corrosion on electrical wiring, plumbing pipes, fuel gas lines, or HVAC equipment, or any components of the foregoing or (ii) has been designated by the U.S. Consumer Product Safety Commission as a product with a product defect that constitutes a substantial product hazard within the meaning of § 15(a)(2) of the Consumer Product Safety Act (15 USC § 2064(a)(2)).

J. Section 112.5.1.1.2 Permit. Application for a permit shall be made to the building official, and a permit shall be obtained prior to the commencement of remediation work undertaken to remove defective drywall from a building and for the removal, replacement, or repair of corroded electrical, plumbing, mechanical, or fuel gas equipment and components.

K. Section 112.5.1.1.3 Protocol. Where remediation of defective drywall is undertaken, the following standards shall be met. The building official shall be permitted to consider and approve modifications to these standards in accordance with Section 106.3.

L. Section 112.5.1.1.3.1 Drywall. Drywall in the building, whether defective or nondefective, shall be removed and discarded, including fasteners that held any defective drywall to prevent small pieces of drywall from remaining under fasteners.

Exceptions:

1. Nondefective drywall not subject to the corrosive effects of any defective drywall shall be permitted to be left in place in buildings where the defective drywall is limited to a defined room or space or isolated from the rest of the building and the defective drywall can be positively identified. If the room or space containing the defective drywall also contains any nondefective drywall, the

Regulations

nondefective drywall in that room or space shall also be removed.

2. In multifamily buildings where defective drywall was not used in the firewalls between units and there are no affected building systems behind the firewalls, the firewalls shall be permitted to be left in place.

M. Section 112.5.1.1.3.2 Insulation and other building components. Insulation in walls and ceilings shall be removed and discarded. Carpet and vinyl flooring shall be removed and discarded. Woodwork, trim, cabinets, and tile or wood floors may be left in place or may be reused.

Exceptions:

1. Closed-cell foam insulation is permitted to be left in place if testing for off-gassing from defective drywall is negative, unless its removal is required to gain access.

2. Insulation, carpet, or vinyl flooring in areas not exposed to defective drywall or to the effects of defective drywall, may be left in place or reused.

N. Section 112.5.1.1.3.3 Electrical wiring, equipment, devices, and components. All electrical wiring regulated by this code shall be permitted to be left in place, but removal or cleaning of exposed ends of the wiring to reveal clean or uncorroded surfaces is required. All electrical equipment, devices, and components of the electrical system of the building regulated by this code shall be removed and discarded. This shall include all smoke detectors.

Exceptions:

1. Electrical equipment, devices, or components in areas not exposed to the corrosive effects of defective drywall shall be permitted to be left in place or reused. Electrical equipment, devices, or components in areas exposed to the corrosive effects of defective drywall shall be cleaned, repaired, or replaced.

2. Cord and plug connected appliances are not subject to this code and, therefore, cannot be required to be removed or replaced.

Note: All low-voltage wiring associated with security systems, door bells, elevator controls, and other such components shall be removed and replaced or repaired.

O. Section 112.5.1.1.3.4 Plumbing and fuel gas piping, fittings, fixtures, and equipment. All copper fuel gas piping and all equipment utilizing fuel gas with copper, silver, or aluminum components shall be removed and discarded. All copper plumbing pipes and fittings shall be removed and discarded. Plumbing fixtures with copper, silver, or aluminum components shall be removed and discarded.

Exception: Plumbing or fuel gas piping, fittings, fixtures, equipment, or components in areas not exposed to the corrosive effects of defective drywall shall be permitted to be left in place or reused.

P. Section 112.5.1.1.3.5 Mechanical systems. All heating, air-conditioning, and ventilation system components,

including but not limited to ductwork, air-handling units, furnaces, heat pumps, refrigerant lines, and thermostats and associated wiring, shall be removed and discarded.

Exception: Mechanical system components in areas not exposed to the corrosive effects of defective drywall shall be permitted to be left in place or reused.

Q. Section 112.5.1.1.3.6 Cleaning. Following the removal of all materials and components in accordance with Sections 112.5.1.1.3.1 through 112.5.1.1.3.5, the building shall be thoroughly cleaned to remove any particulate matter and dust.

R. Section 112.5.1.1.3.7 Airing out. Following cleaning in accordance with Section 112.5.1.1.3.6, the building shall be thoroughly aired out with the use of open windows and doors and fans.

S. Section 112.5.1.1.3.8 Pre-rebuilding clearance testing. Following the steps outlined above for removal of all materials and components, cleaning and airing out, a pre-rebuilding clearance test shall be conducted with the use of copper or silver coupons and the methodology outlined in the April 2, 2010, joint report by the Consumer Products Safety Commission and the Department of Housing and Urban Development "Interim Remediation Guidance for Homes with Corrosion from Problem Drywall" or with the use of a copper probe and dosimeter. The clearance testing shall confirm that all airborne compounds associated with the defective drywall are at usual environmental background levels. The clearance testing report, certifying compliance, shall be submitted to the building official.

Notes:

1. Where the building is served by a well and prior to conducting clearance tests, all outlets in piping served by the well should be capped or otherwise plugged to prevent contamination of the air sample.

2. To prevent siphoning and evaporation of the trap seals, fixtures should be capped or otherwise plugged to prevent sewer gases from contaminating the air sample.

T. Section 112.5.1.1.3.9 Testing agencies and personnel. Agencies and personnel performing pre-rebuilding or post-rebuilding clearance testing shall be independent of those responsible for all other remediation work and the agencies and personnel shall be appropriately certified or accredited by the Council of Engineering and Scientific Specialty Boards, the American Indoor Air Quality Council, or the World Safety Organization.

Exception: Testing agencies and personnel shall be accepted if certified by an RDP or if the agency employs an RDP to be in responsible charge of the work.

U. Section 112.5.1.1.3.10 Rebuilding standards. The rebuilding of the building shall comply with the edition of the USBC that was in effect when the building was originally built.

V. Section 112.5.1.1.3.11 Post-rebuilding clearance testing. A post-rebuilding clearance test prior to reoccupancy of the

building or structure shall be conducted with the use of copper or silver coupons and the methodology outlined in the April 2, 2010, joint report by the Consumer Products Safety Commission and by the Department of Housing and Urban Development "Interim Remediation Guidance for Homes with Corrosion from Problem Drywall" or with the use of a copper probe and dosimeter. The clearance testing shall confirm that all airborne compounds associated with the defective drywall are at usual environmental background levels. The clearance testing report certifying compliance shall be submitted to the building official.

Notes:

1. Where the building is served by a well and prior to conducting clearance tests, all outlets in piping served by the well should be capped or otherwise plugged to prevent contamination of the air sample.

2. To prevent siphoning and evaporation of the trap seals, fixtures should be capped or otherwise plugged to prevent sewer gases from contaminating the air sample.

W. Section 112.5.1.1.4 Final approval by the building official. Once remediation has been completed in accordance with this section, a certificate or letter of approval shall be issued by the building official. The certificate or letter shall state that the remediation and rebuilding is deemed to comply with this code.

X. Section 112.5.1.1.4.1 Approval of remediation occurring prior to these standards. The building official shall issue a certificate or letter of approval for remediation of defective drywall that occurred prior to the effective date of these standards provided post-rebuilding clearance testing has been performed in accordance with Section 112.5.1.1.3.11, by agencies and personnel complying with Section 112.5.1.1.3.9, and the clearance testing confirms that all airborne compounds associated with the defective drywall are at usual environmental background levels. The clearance testing report certifying compliance shall be submitted to the building official.

13VAC5-63-130. Section 113 Inspections.

A. Section 113.1 General. In accordance with § 36-105 of the Code of Virginia, any building or structure may be inspected at any time before completion, and shall not be deemed in compliance until approved by the inspecting authority. Where the construction cost is less than \$2,500, however, the inspection may, in the discretion of the inspecting authority, be waived. The building official shall coordinate all reports of inspections for compliance with the USBC, with inspections of fire and health officials delegated such authority, prior to the issuance of an occupancy permit.

B. Section 113.1.1 Equipment required. Any ladder, scaffolding or test equipment necessary to conduct or witness a requested inspection shall be provided by the permit holder.

C. Section 113.1.2 Duty to notify. When construction reaches a stage of completion that requires an inspection, the permit holder shall notify the building official.

D. Section 113.1.3 Duty to inspect. Except as provided for in Section 113.7, the building official shall perform the requested inspection in accordance with Section 113.6 when notified in accordance with Section 113.1.2.

E. Section 113.2 Prerequisites. The building official may conduct a site inspection prior to issuing a permit. When conducting inspections pursuant to this code, all personnel shall carry proper credentials.

F. Section 113.3 Minimum inspections. The following minimum inspections shall be conducted by the building official when applicable to the construction or permit:

1. Inspection of footing excavations and reinforcement material for concrete footings prior to the placement of concrete.
2. Inspection of foundation systems during phases of construction necessary to assure compliance with this code.
3. Inspection of preparatory work prior to the placement of concrete.
4. Inspection of structural members and fasteners prior to concealment.
5. Inspection of electrical, mechanical and plumbing materials, equipment and systems prior to concealment.
6. Inspection of energy conservation material prior to concealment.
7. Final inspection.

G. Section 113.4 Additional inspections. The building official may designate additional inspections and tests to be conducted during the construction of a building or structure and shall so notify the permit holder.

H. Section 113.5 In-plant and factory inspections. When required by the provisions of this code, materials, equipment or assemblies shall be inspected at the point of manufacture or fabrication. The building official shall require the submittal of an evaluation report of such materials, equipment or assemblies. The evaluation report shall indicate the complete details of the assembly including a description of the assembly and its components, and describe the basis upon which the assembly is being evaluated. In addition, test results and other data as necessary for the building official to determine conformance with the USBC shall be submitted. For factory inspections, an identifying label or stamp permanently affixed to materials, equipment or assemblies indicating that a factory inspection has been made shall be acceptable instead of a written inspection report, provided the intent or meaning of such identifying label or stamp is properly substantiated.

I. Section 113.6 Approval or notice of defective work. The building official shall either approve the work in writing or give written notice of defective work to the permit holder.

Regulations

Upon request of the permit holder, the notice shall reference the USBC section that serves as the basis for the defects and such defects shall be corrected and reinspected before any work proceeds that would conceal such defects. A record of all reports of inspections, tests, examinations, discrepancies and approvals issued shall be maintained by the building official and shall be communicated promptly in writing to the permit holder. Approval issued under this section may be revoked whenever it is discovered that such approval was issued in error or on the basis of incorrect information, or where there are repeated violations of the USBC. Notices issued pursuant to this section shall be permitted to be communicated electronically, provided the notice is reasonably calculated to get to the permit holder.

J. Section 113.7 Approved inspection agencies. The building official may accept reports of inspections and tests from individuals or inspection agencies approved in accordance with the building official's written policy required by Section 113.7.1. The individual or inspection agency shall meet the qualifications and reliability requirements established by the written policy. Under circumstances where the building official is unable to make the inspection or test required by Section 113.3 or 113.4 within two working days of a request or an agreed upon date or if authorized for other circumstances in the building official's written policy, the building official shall accept reports for review. The building official shall approve the report from such approved individuals or agencies unless there is cause to reject it. Failure to approve a report shall be in writing within two working days of receiving it stating the reason for the rejection. Reports of inspections conducted by approved third-party inspectors or agencies shall be in writing, shall indicate if compliance with the applicable provisions of the USBC have been met and shall be certified by the individual inspector or by the responsible officer when the report is from an agency.

Note: Photographs, videotapes or other sources of pertinent data or information may be considered as constituting such reports and tests.

K. Section 113.7.1 Third-party inspectors. Each building official charged with the enforcement of the USBC shall have a written policy establishing the minimum acceptable qualifications for third-party inspectors. The policy shall include the format and time frame required for submission of reports, any prequalification or preapproval requirements before conducting a third-party inspection and any other requirements and procedures established by the building official.

L. Section 113.7.2 Qualifications. In determining third-party inspector qualifications, the building official may consider such items as DHCD inspector certification, other state or national certifications, state professional registrations, related experience, education and any other factors that would

demonstrate competency and reliability to conduct inspections.

M. Section 113.8 Final inspection. Upon completion of a building or structure and before the issuance of a certificate of occupancy, a final inspection shall be conducted to ensure that any defective work has been corrected and that all work complies with the USBC and has been approved, including any work associated with modifications under Section 106.3. The building official shall be permitted to require the electrical service to a building or structure to be energized prior to conducting the final inspection. The approval of a final inspection shall be permitted to serve as the new certificate of occupancy required by Section 116.1 in the case of additions or alterations to existing buildings or structures that already have a certificate of occupancy.

13VAC5-63-160. Section 116 Certificates of occupancy.

A. Section 116.1 General; when to be issued. A certificate of occupancy indicating completion of the work for which a permit was issued shall be obtained prior to the occupancy of any building or structure, except as provided for in this section generally and as specifically provided for in Section 113.8 for additions or alterations. The certificate shall be issued after completion of the final inspection and when the building or structure is in compliance with this code and any pertinent laws or ordinances, or when otherwise entitled. The building official shall, however, issue a certificate of occupancy within five working days after being requested to do so, provided the building or structure meets all of the requirements for a certificate.

Exception: A certificate of occupancy is not required for an accessory structure as defined in the ~~International Residential Code~~ **IRC**.

B. Section 116.1.1 Temporary certificate of occupancy. Upon the request of a permit holder, a temporary certificate of occupancy may be issued before the completion of the work covered by a permit, provided that such portion or portions of a building or structure may be occupied safely prior to full completion of the building or structure without endangering life or public safety.

C. Section 116.2 Contents of certificate. A certificate of occupancy shall specify the following:

1. The edition of the USBC under which the permit is issued.
2. The group classification and occupancy in accordance with the provisions of Chapter 3.
3. The type of construction as defined in Chapter 6.
4. If an automatic sprinkler system is provided and whether or not such system was required.
5. Any special stipulations and conditions of the building permit and if any modifications were issued under the permit, there shall be a notation on the certificate that modifications were issued.

6. Group R-5 occupancies complying with Section R320.2 of the IRC shall have a notation of compliance with that section on the certificate.

D. Section 116.3 Suspension or revocation of certificate. A certificate of occupancy may be revoked or suspended whenever the building official discovers that such certificate was issued in error or on the basis of incorrect information, or where there are repeated violations of the USBC after the certificate has been issued or when requested by the code official under Section 105.7 of the ~~Virginia Maintenance Code VMC~~. The revocation or suspension shall be in writing and shall state the necessary corrections or conditions for the certificate to be reissued or reinstated in accordance with Section 116.3.1.

E. Section 116.3.1 Reissuance of reinstatement of certificate of occupancy. When a certificate of occupancy has been revoked or suspended, it shall be reissued or reinstated upon correction of the specific condition or conditions cited as the cause of the revocation or suspension and the revocation or suspension of a certificate of occupancy shall not be used as justification for requiring a building or structure to be subject to a later edition of the code than that under which such building or structure was initially constructed.

F. Section 116.4 Issuance of certificate for pre-USBC buildings or structures. When a building or structure was constructed prior to being subject to the initial edition of the USBC and the local building department does not have a certificate of occupancy for the building or structure, the owner or owner's agent may submit a written request for a certificate to be created. The building official, after receipt of the request, shall issue a certificate provided a determination is made that there are no current violations of the ~~Virginia Maintenance Code VMC~~ or the Virginia Statewide Fire Prevention Code (13VAC5-51) and the occupancy classification of the building or structure has not changed. Such buildings and structures shall not be prevented from continued use.

Exception: When no certificate exists, but the local building department has records indicating that a certificate did exist, then the building official may either verify in writing that a certificate did exist or issue a certificate based upon the records.

13VAC5-63-170. Section 117 Temporary and moved buildings and structures; demolition.

A. Section 117.1 Temporary building and structures. The building official is authorized to issue a permit for temporary buildings or structures. Such permits shall be limited as to time of service, but shall not be permitted for more than one year, except that upon the permit holder's written request, the building official may grant one or more extensions of time, not to exceed one year per extension. The building official is authorized to terminate the approval and order the demolition or removal of temporary buildings or structures during the period authorized by the permit when determined necessary.

B. Section 117.1.1 Temporary uses within existing buildings and structures. The building official shall review and may approve conditions or modifications for temporary uses, including hypothermia and hyperthermia shelters, that may be necessary as long as the use meets the spirit and functional intent intended by this code. The building official is authorized to terminate the approval and order the discontinuance of the temporary use during the period authorized by the permit when determined necessary. The building official shall notify the appropriate fire official or fire chief of the approved temporary use.

~~B. C.~~ Section 117.2 Moved buildings and structures. Any building or structure moved into a locality or moved to a new location within a locality shall not be occupied or used until a certification of occupancy is issued for the new location. Such moved buildings or structures shall be required to comply with the requirements of this code for a newly constructed building or structure unless meeting all of the following requirements relative to the new location:

1. There is no change in the occupancy classification from its previous location.
2. The building or structure was in compliance with all state and local requirements applicable to it in its previous location and is in compliance with all state and local requirements applicable if originally constructed in the new location.
3. The building or structure did not become unsafe during the moving process due to structural damage or for other reasons.
4. Any alterations, reconstruction, renovations or repairs made pursuant to the move are in compliance with applicable requirements of ~~this code~~ the VRC.

~~C. D.~~ Section 117.3 Demolition of buildings and structures. Prior to the issuance of a permit for the demolition of any building or structure, the owner or the owner's agent shall provide certification to the building official that all service connections of utilities have been removed, sealed or plugged satisfactorily and a release has been obtained from the associated utility company. The certification shall further provide that written notice has been given to the owners of adjoining lots and any other lots that may be affected by the temporary removal of utility wires or the temporary disconnection or termination of other services or facilities relative to the demolition. In addition, the requirements of Chapter 33 of the IBC for any necessary retaining walls or fences during demolition shall be applicable and when a building or structure is demolished or removed, the established grades shall be restored.

13VAC5-63-180. Section 118 ~~Buildings and Unsafe buildings or structures becoming unsafe during construction.~~

A. Section 118.1 Applicability. This section applies to unsafe buildings and or structures for which a construction

Regulations

~~permit has been issued under this code and construction has not been completed or a certificate of occupancy has not been issued, or both. In addition, this section applies to any building or structure that is under construction or that was constructed without obtaining the required permits under this edition or any edition of the USBC.~~

Note: Existing buildings and structures other than those under construction or subject to this section are subject to the ~~Virginia Maintenance Code that~~ VMC, which also has requirements for unsafe conditions.

~~B. Section 118.2 Repair or removal of unsafe buildings or structures. Any unsafe building or structure ~~subject to this section that is either deteriorated, improperly maintained, of faulty construction, deficient in adequate exit facilities, a fire hazard or dangerous to life or the public welfare, or both, or any combination of the foregoing, is an unsafe building or structure~~ and shall be made safe through compliance with this code or shall be taken down and removed if determined necessary by the building official.~~

~~C. Section 118.3 Inspection report and notice of unsafe building or structure. The building official shall inspect any reported unsafe building or structure ~~reported to be unsafe~~ and shall prepare a report to be filed in the records of the local building department. In addition to a description of any unsafe conditions found, the report shall include the occupancy classification of the building or structure and the nature and extent of any damages caused by collapse or failure of any building components. ~~If the~~~~

~~D. Section 118.4 Notice of unsafe building or structure. When a building or structure is determined by the building official to be an unsafe building or structure, a written notice of unsafe building or structure shall be issued in person by personal service to the owner and any permit holder, the owner's agent, or the person in control of such building or structure. The notice shall ~~describe any unsafe conditions and specify any repairs or improvements~~ the corrections necessary to make the building or structure safe, or alternatively, when determined necessary by the building official, require the unsafe building or structure, or any portion of it, to be taken down and removed. ~~The notice shall stipulate a comply with this code and specify the time period within which the repairs must occur, or if the notice specifies that the unsafe building or structure is required to be demolished, the notice shall specify the time period for the repair or within which demolition of the unsafe building or structure and contain a statement requiring the person receiving the notice to determine whether to accept or reject the terms of the notice. If any persons to which the notice of unsafe building or structure is to be issued cannot be found after diligent search, as equivalent service, the notice shall be sent by registered or certified mail to the last known address of such persons and a copy of the notice posted in a conspicuous place on the premises must occur.~~~~

Note: Whenever possible, the notice should also be given to any tenants or occupants of the unsafe building or structure.

~~D. E. Section 118.4 118.4.1 Vacating the unsafe building or structure. If any portion of an unsafe building or structure has collapsed or fallen, or if the building official determines there is actual and immediate danger of any portion collapsing or falling, and to the occupants or public, or when life is endangered by the occupancy of the an unsafe building or structure, the building official shall be authorized to order the occupants to immediately vacate the unsafe building or structure. When an unsafe building or structure is ordered to be vacated, the building official shall post a notice at each entrance that reads as follows:~~

~~"This Building (or Structure) is Unsafe and its Occupancy (or Use) is Prohibited by the Building Official."~~

~~After posting, occupancy or use of the unsafe building or structure shall be prohibited except when authorized to enter to conduct inspections, make required repairs, or as necessary to demolish the building or structure.~~

~~E. E. Section 118.5 Posting of notice. If the notice is unable to be issued by personal service as required by Section 118.4, then the notice shall be sent by registered or certified mail to the last known address of the responsible party and a copy of the notice shall be posted in a conspicuous place on the premises.~~

~~G. Section 118.6 Posting of placard. In the case of an unsafe building or structure, if the notice is not complied with, a placard with the following wording shall be posted at the entrance to the building or structure:~~

~~"This Building (or Structure) is Unfit for Habitation and its Use or Occupancy has been Prohibited by the Building Official."~~

~~After an unsafe building or structure is placarded, entering the unsafe building or structure shall be prohibited except as authorized by the building official to make inspections, to perform required repairs, or to demolish the unsafe building or structure. In addition, the placard shall not be removed until the unsafe building or structure is determined by the building official to be safe to occupy. The placard shall not be defaced.~~

~~H. Section 118.7 Emergency repairs and demolition. To the extent permitted by the locality, the building official may authorize emergency repairs to unsafe buildings or structures when it is determined that there is an immediate danger of any portion of the unsafe building or structure collapsing or falling and when life is endangered. Emergency repairs may also be authorized when there is a code violation resulting in ~~the immediate, a~~ serious and imminent threat to the life and safety of the occupants or public. The building official shall be permitted to authorize the necessary work to make the unsafe building or structure temporarily safe whether or not legal action to compel compliance has been instituted.~~

In addition, whenever an owner of an unsafe building or structure fails to comply with a notice to demolish issued under Section ~~118.3~~ 118.4 in the time period stipulated, the building official shall be permitted to cause the unsafe building or structure to be demolished. In accordance with §§ 15.2-906 and 15.2-1115 of the Code of Virginia, the legal counsel of the locality may be requested to institute appropriate action against the property owner to recover the costs associated with any such emergency repairs or demolition and every such charge that remains unpaid shall constitute a lien against the property on which the emergency repairs or demolition were made and shall be enforceable in the same manner as provided in Articles 3 (§ 58.1-3940 et seq.) and 4 (§ 58.1-3965 et seq.) of Chapter 39 of Title 58.1 of the Code of Virginia.

Note: Building officials and local governing bodies should be aware that other statutes and court decisions may impact on matters relating to demolition, in particular whether newspaper publication is required if the owner cannot be located and whether the demolition order must be delayed until the owner has been given the opportunity for a hearing.

I. Section 118.8 Closing of streets. When necessary for public safety, the building official shall be permitted to order the temporary closing of sidewalks, streets, public ways, or premises adjacent to unsafe buildings or structures and prohibit the use of such spaces.

13VAC5-63-190. Section 119 Appeals.

A. Section 119.1 Establishment of appeals board. In accordance with § 36-105 of the Code of Virginia, there shall be established within each local building department a LBBCA. Whenever a county or a municipality does not have such a LBBCA, the local governing body shall enter into an agreement with the local governing body of another county or municipality or with some other agency, or a state agency approved by DHCD for such appeals resulting therefrom. Fees may be levied by the local governing body in order to defray the cost of such appeals. In addition, as an authorization in this code, separate LBBCAs may be established to hear appeals of different enforcement areas such as electrical, plumbing or mechanical requirements. Each such LBBCA shall comply with the requirements of this section. The locality is responsible for maintaining a duly constituted LBBCA prepared to hear appeals within the time limits established in this section. The LBBCA shall meet as necessary to assure a duly constituted board, appoint officers as necessary, and receive such training on the code as may be appropriate or necessary from staff of the locality.

B. Section 119.2 Membership of board. The LBBCA shall consist of at least five members appointed by the locality for a specific term of office established by written policy. Alternate members may be appointed to serve in the absence of any regular members and as such, shall have the full power and authority of the regular members. Regular and alternate members may be reappointed. Written records of current

membership, including a record of the current chairman and secretary shall be maintained in the office of the locality. In order to provide continuity, the terms of the members may be of different length so that less than half will expire in any one-year period. ~~The LBBCA shall meet at least once annually to assure a duly constituted board, appoint officers as necessary, and receive such training on the code as may be appropriate or necessary from staff of the locality.~~

C. Section 119.3 Officers and qualifications of members. The LBBCA shall annually select one of its regular members to serve as chairman. When the chairman is not present at an appeal hearing, the members present shall select an acting chairman. The locality or the chief executive officer of the locality shall appoint a secretary to the LBBCA to maintain a detailed record of all proceedings. Members of the LBBCA shall be selected by the locality on the basis of their ability to render fair and competent decisions regarding application of the USBC and shall to the extent possible, represent different occupational or professional fields relating to the construction industry. At least one member should be an experienced builder; at least one member should be an RDP, and at least one member should be an experienced property manager. Employees or officials of the locality shall not serve as members of the LBBCA.

D. Section 119.4 Conduct of members. No member shall hear an appeal in which that member has a conflict of interest in accordance with the State and Local Government Conflict of Interests Act (§ 2.2-3100 et seq. of the Code of Virginia). Members shall not discuss the substance of an appeal with any other party or their representatives prior to any hearings.

E. Section 119.5 Right of appeal; filing of appeal application. Any person aggrieved by the local building department's application of the USBC or the refusal to grant a modification to the provisions of the USBC may appeal to the LBBCA. The applicant shall submit a written request for appeal to the LBBCA within 30 calendar days of the receipt of the decision being appealed. The application shall contain the name and address of the owner of the building or structure and in addition, the name and address of the person appealing, when the applicant is not the owner. A copy of the building official's decision shall be submitted along with the application for appeal and maintained as part of the record. The application shall be marked by the LBBCA to indicate the date received. Failure to submit an application for appeal within the time limit established by this section shall constitute acceptance of a building official's decision.

Note: To the extent that a decision of a building official pertains to amusement devices there may be a right of appeal under the VADR.

F. Section 119.6 Meetings and postponements. The LBBCA shall meet within 30 calendar days after the date of receipt of the application for appeal, except that a period of up to 45 calendar days shall be permitted where the LBBCA has regularly scheduled monthly meetings. A longer time period

Regulations

shall be permitted if agreed to by all the parties involved in the appeal. A notice indicating the time and place of the hearing shall be sent to the parties in writing to the addresses listed on the application at least 14 calendar days prior to the date of the hearing, except that a lesser time period shall be permitted if agreed to by all the parties involved in the appeal. When a quorum of the LBBCA is not present at a hearing to hear an appeal, any party involved in the appeal shall have the right to request a postponement of the hearing. The LBBCA shall reschedule the appeal within 30 calendar days of the postponement, except that a longer time period shall be permitted if agreed to by all the parties involved in the appeal.

G. Section 119.7 Hearings and decision. All hearings before the LBBCA shall be open meetings and the appellant, the appellant's representative, the locality's representative and any person whose interests are affected by the building official's decision in question shall be given an opportunity to be heard. The chairman shall have the power and duty to direct the hearing, rule upon the acceptance of evidence and oversee the record of all proceedings. The LBBCA shall have the power to uphold, reverse or modify the decision of the official by a concurring vote of a majority of those present. Decisions of the LBBCA shall be final if no further appeal is made. The decision of the LBBCA shall be by resolution signed by the chairman and retained as part of the record of the appeal. Copies of the resolution shall be sent to all parties by certified mail. In addition, the resolution shall contain the following wording:

"Any person who was a party to the appeal may appeal to the State Review Board by submitting an application to such Board within 21 calendar days upon receipt by certified mail of this resolution. Application forms are available from the Office of the State Review Board, 600 East Main Street, Richmond, Virginia 23219, (804) 371-7150."

H. Section 119.8 Appeals to the State Review Board. After final determination by the LBBCA in an appeal, any person who was a party to the appeal may further appeal to the State Review Board. In accordance with § 36-98.2 of the Code of Virginia for state-owned buildings and structures, appeals by an involved state agency from the decision of the building official for state-owned buildings or structures shall be made directly to the State Review Board. The application for appeal shall be made to the State Review Board within 21 calendar days of the receipt of the decision to be appealed. Failure to submit an application within that time limit shall constitute an acceptance of the building official's decision. For appeals from a LBBCA, a copy of the building official's decision and the resolution of the LBBCA shall be submitted with the application for appeal to the State Review Board. Upon request by the office of the State Review Board, the LBBCA shall submit a copy of all pertinent information from the record of the appeal. In the case of appeals involving state-owned buildings or structures, the involved state agency shall submit a copy of the building official's decision and other

relevant information with the application for appeal to the State Review Board. Procedures of the State Review Board are in accordance with Article 2 (§ 36-108 et seq.) of Chapter 6 of Title 36 of the Code of Virginia. Decisions of the State Review Board shall be final if no further appeal is made.

13VAC5-63-200. Chapter 2 Definitions—Section 202 Definitions.

A. Add the following definitions to Section 202 of the IBC to read:

Aboveground liquid fertilizer storage tank (ALFST). A device that contains an accumulation of liquid fertilizer (i) constructed of nonearthen materials, such as concrete, steel or plastic, that provide structural support; (ii) having a capacity of 100,000 gallons (378 500 L) or greater; and (iii) the volume of which is more than 90% above the surface of the ground. The term does not include any wastewater treatment or wastewater storage tank, utility or industry pollution control equipment.

Building regulations. Any law, rule, resolution, regulation, ordinance or code, general or special, or compilation thereof, heretofore or hereafter enacted or adopted by the Commonwealth or any county or municipality, including departments, boards, bureaus, commissions, or other agencies thereof, relating to construction, reconstruction, alteration, conversion, repair, maintenance, or use of structures and buildings and installation of equipment therein. The term does not include zoning ordinances or other land use controls that do not affect the manner of construction or materials to be used in the erection, alteration or repair of a building or structure.

Change of occupancy. A change in the use or occupancy of any building or structure ~~which~~ that would place the building or structure in a different division of the same group of occupancies or in a different group of occupancies; or a change in the purpose or level of activity within a building or structure that involves a change in application of the requirements of this code.

Construction. The construction, reconstruction, alteration, repair, or conversion of buildings and structures.

Day-night average sound level (Ldn). ~~See Section 1202.1~~ A 24-hour energy average sound level expressed in dBA, with a 10 decibel penalty applied to noise occurring between 10 p.m. and 7 a.m.

DHCD. The Virginia Department of Housing and Community Development.

Emergency communication equipment. ~~See Section 902.1~~ Emergency communication equipment, includes but is not limited to two-way radio communications, signal booster, bi-directional amplifiers, radiating cable systems, or internal multiple antenna, or a combination of the foregoing.

Emergency public safety personnel. ~~See Section 902.1~~ Emergency public safety personnel includes firefighters,

emergency medical personnel, law-enforcement officers, and other emergency public safety personnel routinely called upon to provide emergency assistance to members of the public in a wide variety of emergency situations, including but not limited to fires, medical emergencies, violent crimes, and terrorist attacks.

Equipment. Plumbing, heating, electrical, ventilating, air-conditioning and refrigeration equipment, elevators, dumbwaiters, escalators, and other mechanical additions or installations.

Farm building or structure. A building or structure not used for residential purposes, located on property where farming operations take place, and used primarily for any of the following uses or combination thereof:

1. Storage, handling, production, display, sampling or sale of agricultural, horticultural, floricultural or silvicultural products produced in the farm.
2. Sheltering, raising, handling, processing or sale of agricultural animals or agricultural animal products.
3. Business or office uses relating to the farm operations.
4. Use of farm machinery or equipment or maintenance or storage of vehicles, machinery or equipment on the farm.
5. Storage or use of supplies and materials used on the farm.
6. Implementation of best management practices associated with farm operations.

Hospice facility. An institution, place, or building owned or operated by a hospice provider and licensed by the Virginia Department of Health as a hospice facility to provide room, board, and palliative and supportive medical and other health services to terminally ill patients and their families, including respite and symptom management, on a 24-hour basis to individuals requiring such care pursuant to the orders of a physician.

Industrialized building. A combination of one or more sections or modules, subject to state regulations and including the necessary electrical, plumbing, heating, ventilating and other service systems, manufactured off-site and transported to the point of use for installation or erection, with or without other specified components, to comprise a finished building. Manufactured homes shall not be considered industrialized buildings for the purpose of this code.

Hospice facility. See Section 308.3.1.

LBBCA. Local board of building code appeals.

Liquid fertilizer. A fluid in which a fertilizer is in true solution. This term does not include anhydrous ammonia or a solution used in pollution control.

Local building department. The agency or agencies of any local governing body charged with the administration, supervision, or enforcement of this code, approval of

construction documents, inspection of buildings or structures, or issuance of permits, licenses, certificates or similar documents.

Local governing body. The governing body of any city, county or town in this Commonwealth.

Locality. A city, county or town in this Commonwealth.

Manufactured home. A structure subject to federal regulation, which is transportable in one or more sections; is eight body feet or more in width and 40 body feet or more in length in the traveling mode, or is 320 or more square feet when erected on site; is built on a permanent chassis; is designed to be used as a single-family dwelling, with or without a permanent foundation, when connected to the required utilities; and includes the plumbing, heating, air-conditioning, and electrical systems contained in the structure.

Marina. Any installation, operating under public or private ownership, that has a structure providing dockage or moorage for boats, other than paddleboats or rowboats, and provides, through sale, rental, fee, or on a free basis, any equipment, supply, or service, including fuel, electricity, or water, for the convenience of the public or its lessees, renters, or users of its facilities. A dock or pier with or without slips that exclusively serves a single-family residential lot for the use of the owner of the lot is not a marina.

Night club. Any building in which the main use is a place of public assembly that provides exhibition, performance or other forms of entertainment; serves alcoholic beverages; and provides music and space for dancing.

Skirting. A weather-resistant material used to enclose the space from the bottom of the manufactured home to grade.

Slip. A berth or space where a boat may be secured to a fixed or floating structure, including a dock, finger pier, boat lift, or mooring buoy.

Sound transmission class (STC) rating. ~~See Section 1202.4~~ A single number characterizing the sound reduction performance of a material tested in accordance with ASTM E90-90, "Laboratory Measurement of Airborne Sound Transmission Loss of Building Partitions."

State regulated care facility (SRCF). A building with an occupancy in Group R-2, R-3, R-4 or R-5 occupied by persons in the care of others where program oversight is provided by the Virginia Department of Social Services, the Virginia Department of Behavioral Health and Developmental Services, the Virginia Department of Education or the Virginia Department of Juvenile Justice.

State Review Board. The Virginia State Building Code Technical Review Board as established under § 36-108 of the Code of Virginia.

Technical assistant. Any person employed by or under an extended contract to a local building department or local enforcing agency for enforcing the USBC, including but

Regulations

not limited to inspectors and plans reviewers. For the purpose of this definition, an extended contract shall be a contract with an aggregate term of 18 months or longer.

~~Technical production area. See Section 410.2.~~

Tenable environmental. An environment in which the products of combustion, including smoke, toxic gases, particulates, and heat, are limited or otherwise restricted in order to maintain the impact on occupants, including those in the area of fire origin, to a level that is not life threatening and permits the rescue of occupants for a limited time.

Unsafe building or structure. Any building or structure that is under construction and has not received a permanent certificate of occupancy, final inspection, or for which a permit was never issued or has expired and has been determined by the building official to be of faulty construction that is so damaged, decayed, dilapidated, structurally unsafe, or of such faulty construction or unstable foundation that partial or complete collapse is likely, or any unfinished construction that does not have a valid permit, or the permit has been revoked, and the condition of the unfinished construction presents an immediate serious and imminent threat to the life and safety of the occupants or the public.

VADR. The Virginia Amusement Device Regulations (13VAC5-31).

VCS. The Virginia Certification Standards (13VAC5-21).

Working day. A day other than Saturday, Sunday or a legal local, state or national holiday.

B. Change the following definitions in Section 202 of the IBC to read:

24-hour basis. The actual time that a person is an occupant within a facility for the purpose of receiving care. It shall not include a facility that is open for 24 hours and is capable of providing care to someone visiting the facility during any segment of the 24 hours.

Ambulatory health care facility. Buildings or portions thereof that are licensed by the Virginia Department of Health as outpatient surgical hospitals.

Automatic fire-extinguishing system. An approved system of devices and equipment that automatically detects a fire and discharges an approved fire-extinguishing agent onto or in the area of a fire and includes among other systems an automatic sprinkler system, unless otherwise expressly stated.

Building. A combination of materials, whether portable or fixed, having a roof to form a structure for the use or occupancy by persons, or property. The word "building" shall be construed as though followed by the words "or part or parts thereof" unless the context clearly requires a different meaning. "Building" shall not include roadway tunnels and bridges owned by the Virginia Department of Transportation, which shall be governed by construction

and design standards approved by the Virginia Commonwealth Transportation Board.

For application of this code, each portion of a building that is completely separated from other portions by fire walls complying with Section 706 shall be considered as a separate building (see Section 503.1).

Custodial care. Assistance with day-to-day living tasks, such as assistance with cooking, taking medication, bathing, using toilet facilities, and other tasks of daily living. In other than in hospice facilities, custodial care includes occupants that have the ability to respond to emergency situations and evacuate at a slower rate or who have mental and psychiatric complications, or both.

Group home. A facility for social rehabilitation or substance abuse or mental health problems that contains a group housing arrangement that provides custodial care but does not provide medical care.

Owner. The owner or owners of the freehold of the premises or lesser estate therein, a mortgagee or vendee in possession, assignee of rents, receiver, executor, trustee or lessee in control of a building or structure.

Registered Design Professional (RDP). An architect or professional engineer, licensed to practice architecture or engineering, as defined under § 54.1-400 of the Code of Virginia.

Swimming pool. An aquatic vessel as defined in the International Swimming Pool and Spa Code (ISPSA).

Structure. An assembly of materials forming a construction for occupancy or use including stadiums, gospel and circus tents, reviewing stands, platforms, stagings, observation towers, radio towers, water tanks, storage tanks (underground and aboveground), trestles, piers, wharves, swimming pools, amusement devices, storage bins, and other structures of this general nature but excluding water wells. The word "structure" shall be construed as though followed by the words "or part or parts thereof" unless the context clearly requires a different meaning. "Structure" shall not include roadway tunnels and bridges owned by the Virginia Department of Transportation, which shall be governed by construction and design standards approved by the Virginia Commonwealth Transportation Board.

C. Delete the following definitions from Section 202 of the IBC:

Agricultural, building-

Existing structure (For Chapter 34)-

Fly gallery-

Gridiron-

13VAC5-63-210. Chapter 3 Use and occupancy classification.

A. Change Section 303.6 of the IBC to read:

303.6 Assembly Group A-5. Assembly uses intended for participation in or viewing outdoor activities including, but not limited to:

Amusement park structures

Bleachers

Grandstands

Stadiums

Swimming pools

B. Change exception 13 of Section 307.1 of the IBC to read:

13. The storage of black powder, smokeless propellant and small arms primers in Groups M, R-3 and R-5 and special industrial explosive devices in Groups B, F, M and S, provided such storage conforms to the quantity limits and requirements prescribed in the ~~International Fire Code IFC~~, as amended in Section 307.9.

~~B.~~ C. Add Section 307.9 to the IBC to read:

307.9 Amendments. The following changes shall be made to the ~~International Fire Code IFC~~ for the use of Exception 13 in Section 307.1:

1. Change the following definition in Section 202 of the IFC to read:

Smokeless propellants. Solid propellants, commonly referred to as smokeless powders, or any propellants classified by DOTn as smokeless propellants in accordance with NA3178 (Smokeless Powder for Small Arms), used in small arms ammunition, firearms, cannons, rockets, propellant-actuated devices, and similar articles.

2. Change Section 314.1 of the IFC to read as follows:

314.1 General. Indoor displays constructed within any building or structure shall comply with Sections 314.2 through 314.5.

~~2.~~ 3. Add new Section 314.5 to the IFC to read as follows:

314.5 Smokeless powder and small arms primers. Vendors shall not store, display or sell smokeless powder or small arms primers during trade shows inside exhibition halls except as follows:

1. The amount of smokeless powder each vender may store is limited to the storage arrangements and storage amounts established in Section ~~3306.5.2.1~~ 5506.5.2.1.

2. Smokeless powder shall remain in the manufacturer's original sealed container and the container shall remain sealed while inside the building. The repackaging of smokeless powder shall not be performed inside the building. Damaged containers shall not be repackaged inside the building and shall be immediately removed from the building in such manner to avoid spilling any powder.

3. There shall be at least 50 feet separation between vendors and 20 feet from any exit.

4. Small arms primers shall be displayed and stored in the manufacturer's original packaging and in accordance with the requirements of Section ~~3306.5.2.3~~ 5506.5.2.3.

~~3.~~ 4. Change Exception 4 and add Exceptions 10 and 11 to Section ~~3304.1~~ 5501.1 of the IFC as follows:

4. The possession, storage and use of not more than 15 pounds (6.75 kg) of commercially manufactured sporting black powder, 20 pounds (9 kg) of smokeless powder and any amount of small arms primers for hand loading of small arms ammunition for personal consumption.

10. The display of small arms primers in Group M when in the original manufacturer's packaging.

11. The possession, storage and use of not more than 50 pounds (23 kg) of commercially manufactured sporting black powder, 100 pounds (45 kg) of smokeless powder, and small arms primers for hand loading of small arms ammunition for personal consumption in Group R-3 or R-5, or 200 pounds (91 kg) of smokeless powder when stored in the manufacturer's original containers in detached Group U structures at least 10 feet (3048 mm) from inhabited buildings and are accessory to Group R-3 or R-5.

~~4.~~ Change the definition of Smokeless Propellants in Section ~~3302.1~~ of the IFC as follows:

~~SMOKELESS PROPELLANTS. Solid propellants, commonly referred to as smokeless powders, or any propellants classified by DOTn as smokeless propellants in accordance with NA3178 (Smokeless Powder for Small Arms), used in small arms ammunition, firearms, cannons, rockets, propellant-actuated devices and similar articles.~~

5. Change Section ~~3306.4~~ 5506.4 of the IFC to read as follows:

~~3306.4~~ 5506.4 Storage in residences. Propellants for personal use in quantities not exceeding 50 pounds (23 kg) of black powder or 100 pounds (45 kg) of smokeless powder shall be stored in original containers in occupancies limited to Group R-3 and R-5 or 200 pounds (91 kg) of smokeless powder when stored in the manufacturer's original containers in detached Group U structures at least 10 feet (3048 mm) from inhabited buildings and are accessory to Group R-3 or R-5. In other than Group R-3 or R-5, smokeless powder in quantities exceeding 20 pounds (9 kg) but not exceeding 50 pounds (23 kg) shall be kept in a wooden box or cabinet having walls of at least one inch (25 mm) nominal thickness or equivalent.

6. Delete Sections ~~3306.4.1~~ 5506.4.1 and ~~3306.4.2~~ 5506.4.2 of the IFC.

7. Change Section ~~3306.5.1.1~~ 5506.5.1.1 of the IFC to read as follows:

~~3306.5.1.1~~ 5506.5.1.1 Smokeless propellant. No more than 100 pounds (45 kg) of smokeless propellants in

Regulations

containers of eight pounds (3.6 kg) or less capacity shall be displayed in Group M occupancies.

8. Delete Section ~~3306.5.1.3~~ 5506.5.1.3 of the IFC.

9. Change Section ~~3306.5.2.1~~ 5506.5.2.1 of the IFC as follows:

~~3306.5.2.1~~ 5506.5.2.1 Smokeless propellant. Commercial stocks of smokeless propellants shall be stored as follows:

1. Quantities exceeding 20 pounds (9 kg), but not exceeding 100 pounds (45 kg) shall be stored in portable wooden boxes having walls of at least one inch (25 mm) nominal thickness or equivalent.

2. Quantities exceeding 100 pounds (45 kg), but not exceeding 800 pounds (363 kg), shall be stored in storage cabinets having walls at least one inch (25 mm) nominal thickness or equivalent. Not more than 400 pounds (182 kg) shall be stored in any one cabinet, and cabinets shall be separated by a distance of at least 25 feet (7620 mm) or by a fire partition having a fire-resistance rating of at least one hour.

3. Storage of quantities exceeding 800 pounds (363 kg), but not exceeding 5,000 pounds (2270 kg) in a building shall comply with all of the following:

3.1. The storage is inaccessible to unauthorized personnel.

3.2. Smokeless propellant shall be stored in nonportable storage cabinets having wood walls at least one inch (25 mm) nominal thickness or equivalent and having shelves with no more than 3 feet (914 mm) of vertical separation between shelves.

3.3. No more than 400 pounds (182 kg) is stored in any one cabinet.

3.4. Cabinets shall be located against walls with at least 40 feet (12 192 mm) between cabinets. The minimum required separation between cabinets may be reduced to 20 feet (6096 mm) provided that barricades twice the height of the cabinets are attached to the wall, midway between each cabinet. The barricades must extend a minimum of 10 feet (3048 mm) outward, be firmly attached to the wall, and be constructed of steel not less than 0.25 inch thick (6.4 mm), 2-inch (51 mm) nominal thickness wood, brick, or concrete block.

3.5. Smokeless propellant shall be separated from materials classified as combustible liquids, flammable liquids, flammable solids, or oxidizing materials by a distance of 25 feet (7620 mm) or by a fire partition having a fire-resistance rating of 1 hour.

3.6. The building shall be equipped throughout with an automatic sprinkler system installed in accordance with Section 903.3.1.1.

4. Smokeless propellants not stored according to Item 1, 2, or 3 above shall be stored in a Type 2 or 4 magazine in accordance with Section 3304 and NFPA 495.

~~C. Change~~ D. Add the following to the list of terms in Section 308.2 of the IBC to read:

Hospice facility

E. Change Section 308.3 of the IBC to read:

~~308.2~~ 308.3 Institutional Group I-1. This occupancy shall include buildings, structures or ~~parts~~ portions thereof ~~housing for~~ for more than 16 persons, excluding staff, who reside on a 24-hour basis, who because of age, mental disability or other reasons, live in a supervised residential environment that provides personal and receive custodial care services. The occupants are capable of responding to an emergency situation without physical assistance from staff. Buildings of Group I-1, other than assisted living facilities licensed by the Virginia Department of Social Services, shall be classified as the occupancy condition indicated in Section 308.3.1. Assisted living facilities licensed by the Virginia Department of Social Services shall be classified as one of the occupancy conditions indicated in Section 308.3.1 or 308.3.2. This group shall include, but not be limited to, the following:

Alcohol and drug centers

Assisted living facilities

Congregate care facilities

Group homes

Halfway houses

Residential board and care facilities

Social rehabilitation facilities

Exception: In Group I-1 occupancies classified as the occupancy condition indicated in Section 308.3.1, not more than five of the residents may require physical assistance from staff to respond to an emergency situation when all residents that may require the physical assistance reside on a single level of exit discharge.

~~A facility such as the above with five or fewer persons shall be classified as a Group R-3 or shall comply with the International Residential Code in accordance with Section 101.2. A facility such as above, housing at least six and not more than 16 persons, shall be classified as Group R-4.~~

F. Change Sections 308.3.1 and 308.3.2 of the IBC to read:

308.3.1 Condition 1. This occupancy condition shall include buildings in which all persons receiving custodial care who, without any assistance, are capable of responding to an emergency situation to complete building evacuation.

308.3.2 Condition 2. This occupancy condition shall include buildings in which there are persons receiving custodial care who require assistance by not more than one

staff member while responding to an emergency situation to complete building evacuation.

G. Add Sections 308.3.3 and 308.3.4 to the IBC to read:

308.3.3 Six to 16 persons receiving custodial care. A facility housing not fewer than six and not more than 16 persons receiving custodial care shall be classified as Group R-4.

308.3.4 Five or fewer persons receiving custodial care. A facility with five or fewer persons receiving custodial care shall be classified as Group R-3 or shall comply with the IRC provided an automatic sprinkler system is installed in accordance with Section 903.3.1.3 or with Section P2904 of the IRC.

D. ~~H.~~ Change Section ~~308.3~~ 308.4 of the IBC to read:

~~308.3~~ 308.4 Group I-2. This occupancy shall include buildings and structures used for medical, ~~surgical,~~ psychiatric, nursing or custodial care on a 24-hour basis for more than five persons who are not capable incapable of self-preservation. This group shall include, but not be limited to, the following:

- ~~Child care facilities~~
- Convalescent facilities
- Detoxification facilities
- Foster care facilities
- Hospice facilities
- Hospitals
- ~~Mental hospitals~~
- Nursing homes
- Psychiatric hospitals

Exception: Hospice facilities occupied by 16 or less occupants, excluding staff, are permitted to be classified as Group R-4.

E. ~~Add the following definition to Section 308.3.1 of the IBC:~~

~~Hospice facility. An institution, place, or building owned or operated by a hospice provider and licensed by the Virginia Department of Health as a hospice facility to provide room, board, and palliative and supportive medical and other health services to terminally ill patients and their families, including respite and symptom management, on a 24-hour basis to individuals requiring such care pursuant to the orders of a physician.~~

F. ~~Change I.~~ Add an exception to Section ~~308.5.2~~ 308.6 of the IBC to read:

~~308.5.2 Child care facility. A facility other than family day homes under Section 310.4 that provides supervision and personal care on less than a 24-hour basis for more than five children 2-1/2 years of age or less shall be classified as Group I-4.~~

Exception: A child day care facility that provides care for more than five but no more than 100 children 2-1/2 years or less of age, where the rooms in which the children are cared for are located on a level of exit discharge serving such rooms and each of these child care rooms has an exit door directly to the exterior, shall be classified as Group E Family day homes under Section 310.9.

G. ~~J.~~ Change occupancy classifications "R-1" and "R-4" and add new occupancy classification "R-5" to Section ~~310~~ 310.3 of the IBC to read:

310.3 Residential Group R-1. Residential occupancies containing sleeping units where the occupants are primarily transient in nature, including:

- Boarding houses (transient) with more than 10 occupants
- Congregate living facilities (transient) with more than 10 occupants
- Hotels (transient)
- Motels (transient)

~~Congregate living facilities (transient) with 10 or fewer occupants are permitted to comply with the construction requirements for Group R-3.~~

Exceptions:

1. Nonproprietor occupied bed and breakfast and other transient boarding facilities not more than three stories above grade plane in height with a maximum of 10 occupants total are permitted to be classified as either Group R-3 or ~~Group~~ R-5 provided that smoke alarms are installed in compliance with Section ~~907.2.10.1.2~~ 907.2.11.2 for Group R-3 or Section ~~313.1~~ R314 of the ~~International Residential Code IRC~~ for Group R-5.
2. Proprietor occupied bed and breakfast and other transient boarding facilities not more than three stories above grade plane in height, that are also occupied as the residence of the proprietor, with a maximum of five guest room sleeping units provided for the transient occupants are permitted to be classified as either Group R-3 or R-5 provided that smoke alarms are installed in compliance with Section ~~907.2.10.1.2~~ 907.2.11.2 for Group R-3 or Section ~~313.1~~ R314 of the ~~International Residential Code IRC~~ for Group R-5.

K. Change Section 310.6 of the IBC to read:

310.6 Residential Group R-4 Residential occupancies. This occupancy shall include buildings arranged for occupancy as residential care/assisted living facilities including structures or portions thereof for more than five but not more than 16 occupants persons, excluding staff and buildings arranged for occupancy as, who reside on a 24-hour basis in a supervised environment and receive custodial care. Buildings of Group R-4, other than assisted living facilities licensed by the Virginia Department of Social Services, shall be classified as the occupancy condition indicated in Section 310.6.1. Assisted living

Regulations

facilities licensed by the Virginia Department of Social Services shall be classified as one of the occupancy conditions indicated in Sections 310.6.1 or 310.6.2. This group shall include, but not be limited to the following:

Alcohol and drug centers

Assisted living facilities

Congregate care facilities

Group homes

Halfway houses

Residential board and care facilities

Social rehabilitation facilities

This occupancy shall also include hospice facilities with not more than 16 occupants, excluding staff.

Group R-4 occupancies shall meet the requirements for construction as defined for Group R-3, except as otherwise provided for in this code, ~~or shall comply with the IRC provided the building is protected by an automatic sprinkler system installed in accordance with Section 903.2.7.~~

Exceptions:

1. Group homes licensed by the Virginia Department of Behavioral Health and Developmental Services that house no more than eight persons with one or more resident counselors shall be classified as Group R-2, R-3, R-4 or R-5. Not more than five of the persons may require physical assistance from staff to respond to an emergency situation.

2. In Group R-4 occupancies classified as the occupancy condition indicated in Section 310.6.1, other than in hospice facilities, not more than five of the residents may require physical assistance from staff to respond to an emergency situation when all residents who may require the physical assistance from staff reside on a single level of exit discharge and other than using a ramp, a change of elevation using steps or stairs is not within the path of egress to an exit door.

3. Assisted living facilities licensed by the Virginia Department of Social Services that house no more than eight persons, with one or more resident counselors, and all of the residents are capable of responding to an emergency situation without physical assistance from staff, may be classified as Group R-2, R-3 or R-5.

4. Assisted living facilities licensed by the Virginia Department of Social Services that house no more than eight persons, with one or more resident counselors, may be classified as Group R-5 when in compliance with all of the following:

4.1. The building is protected by an automatic sprinkler system installed in accordance with Section 903.3 or Section P2904 of the IRC.

4.2. Not more than five of the residents may require physical assistance from staff to respond to an emergency situation.

4.3. All residents who may require physical assistance from staff to respond to an emergency situation reside on a single level of exit discharge and other than using a ramp, a change in elevation using steps or stairs is not within the path of egress to an exit door.

5. Hospice facilities with five or fewer occupants are permitted to comply with the IRC provided the building is protected by an automatic sprinkler system in accordance with IRC Section P2904 or IBC Section 903.3.

L. Add Sections 310.6.1 and 310.6.2 to the IBC to read:

310.6.1 Condition 1. This occupancy condition shall include buildings in which all persons receiving custodial care who, without any assistance, are capable of responding to an emergency situation to complete building evacuation and hospice facilities.

310.6.2 Condition 2. This occupancy condition shall include buildings in which there are persons receiving custodial care who require assistance by not more than one staff member while responding to an emergency situation to complete building evacuation.

M. Add Section 310.7 to the IBC to read:

310.7 Residential Group R-5. Residential occupancies in detached ~~one-~~ single-family and two-family dwellings, townhouses and accessory structures within the scope of the ~~International Residential Code, also referred to as the~~ "IRC."

H. Change the definition of "Residential care/assisted living facilities" in Section 310.2 of the IBC to read:

~~Residential care/assisted living facilities. Any congregate residential setting that provides or coordinates personal and health care services, 24-hour supervision and assistance for the maintenance or care of four or more adults who are aged, infirm or disabled and who are cared for in a primarily residential setting, and provides for the protection, general supervision and oversight of the physical and mental well-being of aged, infirmed or disabled individuals. Residents are capable of self-evacuation.~~

I. N. Add Section ~~310.3~~ 310.8 to the IBC to read:

~~310.3~~ 310.8 Group R-5. The construction of Group R-5 structures shall comply with the IRC. The amendments to the IRC set out in Section ~~310.6~~ 310.11 shall be made to the IRC for its use as part of this code. In addition, all references to ~~Section 101.2 in the IBC relating to the construction of such structures subject to the IRC in the~~ IBC shall be considered to be references to this section.

J. O. Add Section ~~310.3.1~~ 310.8.1 to the IBC to read:

~~310.3.1~~ 310.8.1 Additional requirements. Methods of construction, materials, systems, equipment or components for Group R-5 structures not addressed by prescriptive or performance provisions of the IRC shall comply with applicable IBC requirements.

~~K. P.~~ Add Section ~~310.4~~ 310.9 to the IBC to read:

~~310.4~~ 310.9 Family day homes. Family day homes where program oversight is provided by the Virginia Department of Social Services shall be classified as Group R-2, R-3 or R-5.

Note: Family day homes may generally care for up to 12 children. See the DHCD Related Laws Package for additional information.

~~L. Q.~~ Add Section ~~310.5~~ 310.10 to the IBC to read:

~~310.5~~ 310.10 Radon-resistant construction in ~~Group Groups~~ R-3 and R-4 structures. ~~Group Groups~~ R-3 and R-4 structures shall be subject to the radon-resistant construction requirements in Appendix F ~~of the IRC~~ in localities enforcing such requirements pursuant to Section ~~R325~~ R324 of the IRC.

~~M. R.~~ Add Section ~~310.6~~ 310.11 to the IBC to read:

~~310.6~~ 310.11 Amendments to the IRC. The following changes shall be made to the IRC for its use as part of this code:

1. Add the following definitions to read:

Nonpotable fixtures and outlets. Fixtures and outlets that are not dependent on potable water for the safe operation to perform their intended use. Such fixtures and outlets may include, but are not limited to water closets, urinals, irrigation, mechanical equipment, and hose connections to perform operations, such as vehicle washing and lawn maintenance.

Nonpotable water systems. Water systems for the collection, treatment, storage, distribution, and use or reuse of nonpotable water. Nonpotable systems include reclaimed water, rainwater, and gray water systems.

Rainwater. Natural precipitation, including snow melt, from roof surfaces only.

Stormwater. Precipitation that is discharged across the land surface or through conveyances to one or more waterways and that may include stormwater runoff, snow melt runoff, and surface runoff and drainage.

2. Change the following definition to read:

Gray water. Water discharged from lavatories, bathtubs, showers, clothes washers, and laundry trays.

3. Change Section R301.2.1 to read:

R301.2.1 Wind limitations design criteria. Buildings and portions thereof shall be limited by constructed in accordance with the wind provisions of this code using the basic wind speed, as defined in Table R301.2(1), and construction methods in accordance with this code. Basic

~~wind speeds shall be determined from Figure R301.2(4). Where different construction methods and structural materials are used for various portions of a building, the applicable requirements of this section for each portion shall apply. Where loads for wall coverings, curtain walls, roof coverings, exterior windows, skylights, garage doors and exterior doors are not otherwise specified, the loads listed in Table R301.2(2) adjusted for height and exposure using Table R301.2(3) shall be used to determine design load performance requirements for wall coverings, curtain walls, roof coverings, exterior windows, skylights, garage doors and exterior doors. Asphalt shingles shall be designed for wind speeds in accordance with Section R905.2.6 as determined from Figure R301.2(4)A. The structural provisions of this code for wind loads are not permitted where wind design is required as specified in Section R301.2.1.1. Where different construction methods and structural materials are used for various portions of a building, the applicable requirements of this section for each portion shall apply. Where not otherwise specified, the wind loads listed in Table R301.2(2) adjusted for height and exposure using Table R301.2(3) shall be used to determine design load performance requirements for wall coverings, curtain walls, roof coverings, exterior windows, skylights, garage doors, and exterior doors. Asphalt shingles shall be designed for wind speeds in accordance with Section R905.2.4. A continuous load path shall be provided to transmit the applicable uplift forces in Section R802.11.1 from the roof assembly to the foundation. Wind speeds for localities in special wind regions, near mountainous terrain, and near gorges shall be based on elevation. Areas at 4,000 feet in elevation or higher shall use 110 V mph (48.4 m/s) and areas under 4,000 feet in elevation shall use 90 V mph (39.6 m/s). Gorge areas shall be based on the highest recorded speed per locality or in accordance with local jurisdiction requirements determined in accordance with Section 6.5.4 26.5.1 of ASCE 7.~~

2. Change Section R301.2.1.1 to read:

~~R301.2.1.1 Design criteria.~~ Construction in regions where the basic wind speeds from Figure R301.2(4) equal or exceed 110 miles per hour (49 m/s) shall be designed in accordance with one of the following methods. The elements of design not addressed by those documents in items 1 through 4 shall be in accordance with this code.

~~1. American Forest and Paper Association (AF&PA) Wood Frame Construction Manual for One and Two Family Dwellings (WFCM); or~~

~~2. International Code Council (ICC) Standard for Residential Construction in High Wind Regions (ICC-600); or~~

Regulations

3. Minimum Design Loads for Buildings and Other Structures (ASCE 7); or

4. American Iron and Steel Institute (AISI), Standard for Cold Formed Steel Framing Prescriptive Method for One and Two Family Dwellings (AISI S230).

5. Concrete construction shall be designed in accordance with the provisions of this code.

6. Structural insulated panel (SIP) walls shall be designed in accordance with the provisions of this code.

3. Change Section R301.2.2.1.1 to read:

R301.2.2.1.1 Alternate determination of seismic design category. The Seismic Design Categories and corresponding Short Period Design Spectral Response Accelerations, S_{DS} , shown in Figure R301.2(2) are based on soil Site Class D, as defined in Section 1613.5.2 of the International Building Code. If soil conditions are other than Site Class D, the Short Period Design Spectral Response Accelerations, S_{DS} , for a site can be determined according to Section 1613.5 of the International Building Code. The value of S_{DS} determined according to Section 1613.5 of the International Building Code is permitted to be used to set the seismic design category according to Table R301.2.2.1.1, and to interpolate between values in Tables R602.10.3(3), R603.7 and other seismic design requirements of this code.

4. Delete Section R301.2.2.3 and all subsections.

5. Delete Section R301.2.2.4.

6. Change the exception to Item 1 of Section R301.3 to read:

Exception: For wood framed wall buildings with bracing in accordance with Section R602.10, the wall stud clear height used to determine the maximum permitted story height may be increased to 12 feet (3658 mm) without requiring an engineered design for the building wind and seismic force resisting systems.

7. 4. Add Exception 6 to Section R302.1 to read:

6. Decks and open porches.

8. Change the last column and add footnote "a" to Table R302.1 as shown:

Minimum Fire Separation Distance
<5 feet ^a
≥5 feet ^a
≥2 feet to 5 feet ^a
5 feet ^a
<3 feet
3 feet
5 feet ^a

<5 feet ^a
5 feet ^a

^aThe minimum fire separation distance shall be reduced to three feet in developments which are fully sprinklered as provided for in Sections R313.1 or R313.2.

9. 5. Change the exception in Section R302.2 to require a common two-hour fire-resistance-rated wall instead of a one-hour fire-resistance-rated wall, unless the townhouse development is fully sprinklered as provided for in Section R313.1, in which case a common one-hour fire-resistive-rated wall shall be permitted between townhouses.

10. 6. Add the following sentence to the end of Section R302.3 to read:

Dwelling unit separation wall assemblies that are constructed on a lot line shall be constructed as required in Section R302.2 for townhouses.

7. Change Section R302.5.1 to read:

R302.5.1 Opening protection. Openings from a private garage directly into a room used for sleeping purposes shall not be permitted. Other openings between the garage and residence shall be equipped with solid wood doors not less than 1-3/8 inches (35 mm) thickness, solid or honeycomb-core steel doors not less than 1-3/8 inches (35 mm) thick, or 20-minute fire-rated doors.

11. 8. Add an exception to Section ~~R303.8~~ R303.9 to read:

Exception: Seasonal structures not used as a primary residence for more than 90 days per year, unless rented, leased or let on terms expressed or implied to furnish heat, shall not be required to comply with this section.

12. 9. Add Section ~~R303.8.1~~ R303.9.1 to read:

R303.8.1 R303.9.1 Nonowner occupied required heating. Every dwelling unit or portion thereof which is to be rented, leased or let on terms either expressed or implied to furnish heat to the occupants thereof shall be provided with facilities in accordance with Section ~~R303.8~~ R303.9 during the period from October 15 to May 1.

13. 10. Add Section ~~R303.9~~ R303.10 to read:

R303.9 R303.10 Insect screens. Every door, window and other outside opening required for ventilation purposes shall be supplied with approved tightly fitted screens of not less than 16 mesh per inch (16 mesh per 25 mm) and every screen door used for insect control shall have a self-closing device.

14. 11. Add Section R306.5 to read:

R306.5 Water supply sources and sewage disposal systems. The water and drainage system of any building or premises where plumbing fixtures are installed shall be connected to a public or private water supply and a public or private sewer system. As provided for in Section 103.11 of Part I of the Virginia Uniform Statewide Building Code (13VAC5-63), for functional

design, water supply sources and sewage disposal systems are regulated and approved by the Virginia Department of Health and the Virginia Department of Environmental Quality.

Note: See also the Memorandums of Agreement in the "Related Laws Package," which is available from the Virginia Department of Housing and Community Development.

~~15.~~ 12. Change Section R310.1 to read:

R310.1 Emergency escape and rescue required. Basements, ~~habitable attics,~~ and ~~each every~~ sleeping room designated on the construction documents shall have at least one ~~openable~~ operable emergency escape and rescue opening. ~~Such opening shall be directly to the exterior of the building or to a deck, screen porch or egress court, all of which shall provide access to a public street, public alley or yard. Where basements contain one or more sleeping rooms, emergency egress and rescue openings shall be required in each sleeping room.~~ Where emergency escape and rescue openings are provided, they shall have a sill height of not more than 44 inches (1118 mm) ~~above~~ measured from the finished floor to the bottom of the clear opening. Where a door opening having a threshold below the adjacent ground elevation serves as an emergency escape and rescue opening and is provided with a bulkhead enclosure, the bulkhead enclosure shall comply with Section R310.3. The net clear opening dimensions required by this section shall be obtained by the normal operation of the emergency escape and rescue opening from the inside, except that tilt-out or removable sash designed windows shall be permitted to be used. Emergency escape and rescue openings with a finished height below the adjacent ground elevation shall be provided with a window well in accordance with Section R310.2. Emergency escape and rescue openings shall open directly into a public way, or to a yard or court that opens to a public way.

Exceptions:

1. Dwelling units equipped throughout with an approved automatic sprinkler system installed in accordance with NFPA 13, 13R, or 13D or Section P2904.
2. Basements used only to house mechanical equipment and not exceeding total floor area of 200 square feet (18.58 m²).

~~16.~~ 13. Change Section R310.1.1 to read:

R310.1.1 Minimum opening area. All emergency escape and rescue openings shall have a minimum net clear opening of 5.7 square feet (0.530 m²), including the tilting or removal of the sash as the normal operation to comply with ~~sections~~ Sections R310.1.2 and R310.1.3.

Exception: Grade floor openings shall have a minimum net clear opening of 5 square feet (0.465 m²).

~~17.~~ 14. Change Section ~~R311.7.4.1~~ R311.7.5.1 to read:

~~R311.7.4.1 Riser height~~ R311.7.5.1 Risers. The maximum riser height shall be 8-1/4 inches (210 mm). The riser shall be measured vertically between the leading edges of the adjacent treads. The greatest riser height within any flight of stairs shall not exceed the smallest by more than 3/8 inch (9.5 mm). Risers shall be vertical or sloped from the underside of the nosing of the tread above at an angle not more than 30 degrees (0.51 rad) from the vertical. Open risers are permitted provided that the opening between treads does not permit the passage of a 4-inch-diameter (102 mm) sphere.

Exception: The opening between adjacent treads is not limited on stairs with a total rise of 30 inches (762 mm) or less.

~~18.~~ 15. Change Section ~~R311.7.4.2~~ R311.7.5.2 to read:

~~R311.7.4.2 Tread depth~~ R311.7.5.2 Treads. The minimum tread depth shall be 9 inches (229 mm). The tread depth shall be measured horizontally between the vertical planes of the foremost projection of adjacent treads and at a right angle to the tread's leading edge. The greatest tread depth within any flight of stairs shall not exceed the smallest by more than 3/8 inch (9.5 mm). ~~Consistently shaped winders at the walkline shall be allowed within the same flight of stairs as rectangular treads and do not have to be within 3/8 inch (9.5 mm) of the rectangular tread depth. Winder treads shall have a minimum tread depth of 10 inches (254 mm) measured between the vertical planes of the foremost projection of adjacent treads at the intersection with the walkline. Winder treads shall have a minimum tread depth of 6 inches (152 mm) at any point within the clear width of the stair. Within any flight of stairs, the largest winder tread depth at the walkline shall not exceed the smallest winder tread by more than 3/8 inch (9.5 mm).~~

~~19.~~ 16. Change Section ~~R311.7.6~~ R311.7.7 to read:

~~R311.7.6~~ R311.7.7 Stairway walking surface. The walking surface of treads and landings of stairways shall be level or sloped no steeper than one unit vertical in 48 inches horizontal (~~two percent~~ 2.0% slope).

17. Change Section R312.2.1 to read:

R312.2.1 Window sills. In dwelling units, where the opening of an operable window is located more than 72 inches (1829 mm) above the finished grade or surface below, the lowest part of the clear opening of the window shall be a minimum of 18 inches (457 mm) above the finished floor of the room in which the window is located. Operable sections of windows shall not permit openings that allow passage of a 4-inch-diameter (102 mm) sphere where such openings are located within 18 inches (457 mm) of the finished floor.

Exceptions:

Regulations

1. Windows whose openings will not allow a 4-inch-diameter (102 mm) sphere to pass through the opening when the opening is in its largest opened position.

2. Openings that are provided with window fall prevention devices that comply with ASTM F 2090.

3. Windows that are provided with window opening control devices that comply with Section R312.2.2.

~~20-~~ 18. Replace Section R313 with the following:

Section R313.

Automatic Fire Sprinkler Systems.

R313.1 Townhouse automatic fire sprinkler systems. Notwithstanding the requirements of Section 103.8, where installed, an automatic residential fire sprinkler system for townhouses shall be designed and installed in accordance with NFPA 13D or Section P2904.

Exception: An automatic residential fire sprinkler system shall not be required when additions or alterations are made to existing townhouses that do not have an automatic residential fire sprinkler system installed.

R313.2 One-~~family~~ and two-family dwellings automatic fire sprinkler systems. Notwithstanding the requirements of Section 103.8, where installed, an automatic residential fire sprinkler system shall be designed and installed in accordance with NFPA 13D or Section P2904.

Exception: An automatic residential fire sprinkler system shall not be required for additions or alterations to existing buildings that are not already provided with an automatic residential fire sprinkler system.

~~21-~~ 19. Change Section R314.2 to read:

R314.2 Smoke detection systems. Household fire alarm systems installed in accordance with NFPA 72 that include smoke alarms, or a combination of smoke detector and audible notification device installed as required by this section for smoke alarms, shall be permitted. The household fire alarm system shall provide the same level of smoke detection and alarm as required by this section for smoke alarms. Where a household fire warning system is installed using a combination of smoke detector and audible notification device(s), the system shall become a permanent fixture of the dwelling unit.

Exception: Where smoke alarms are provided meeting the requirements of Section R314.4.

~~22-~~ 20. Delete Section R314.3.1.

~~23-~~ 21. Delete Section ~~R315.2~~ R315.3.

~~24-~~ 22. Change Section ~~R315.2~~ R315.4 to read:

~~R315.3~~ R315.4 Alarm requirements. Single station carbon monoxide alarms shall be hard wired, plug-in or battery type; listed as complying with UL 2034; and

installed in accordance with this code and the manufacturer's installation instructions.

~~23-~~ 23. Add Section R320.2 to read:

R320.2 Universal design features for accessibility in dwellings. Dwellings constructed under the IRC not subject to Section R320.1 may comply with Section 1109.16 of the USBC and be approved by the local building department as dwellings containing universal design features for accessibility.

~~25-~~ 24. Add Section R324 Radon-Resistant Construction.

~~26-~~ 25. Add Section R324.1 to read:

R324.1 Local enforcement of radon requirements. Following official action under Article 7 (§ 15.2-2280 et seq.) of Chapter 22 of Title 15.2 of the Code of Virginia by a locality in areas of high radon potential, as indicated by Zone 1 on the U.S. EPA Map of Radon Zones (IRC Figure AF101), such locality shall enforce the provisions contained in Appendix F.

Exception: Buildings or portions thereof with crawl space foundations which are ventilated to the exterior, shall not be required to provide radon-resistant construction.

~~27-~~ 26. Add Section R325 Swimming Pools, ~~Spas and Hot Tubs.~~

~~28-~~ 27. Add Section R325.1 to read:

~~R325.1 Use of Appendix G for swimming~~ Swimming pools, spas and hot tubs. In addition to other applicable provisions of this code, swimming pools, ~~spas and hot tubs~~ as defined in the USBC, shall comply with the applicable provisions in Appendix G of the ISPSC.

~~29-~~ 28. Add Section R326 Patio Covers.

~~30-~~ 29. Add Section R326.1 to read:

R326.1 Use of Appendix H for patio covers. Patio covers shall comply with the provisions in Appendix H.

~~31-~~ 30. Add Section R327 Sound Transmission.

~~32-~~ 31. Add Section R327.1 to read:

R327.1 Sound transmission between dwelling units. Construction assemblies separating dwelling units shall provide airborne sound insulation as required in Appendix K.

~~33-~~ 32. Add Section R327.2 to read:

R327.2 Airport noise attenuation. This section applies to the construction of the exterior envelope of detached one-family and two-family dwellings and multiple single-family dwellings (townhouses) not more than three stories high with separate means or egress within airport noise zones when enforced by a locality pursuant to § 15.2-2295 of the Code of Virginia. The exterior envelope of such structures shall comply with Section 1207.4 of the state amendments to the IBC.

~~34. Add Section R328 Gray Water and Rain Water Recycling Systems.~~

~~35. Add Section R328.1 to read:~~

~~R328.1 Use of Appendix O for gray water and rain water recycling systems. In addition to other applicable provisions of this code, gray water recycling systems and rain water recycling systems shall comply with the provisions in Appendix O. In the use of Appendix O for rain water recycling systems, the term "rain water" shall be substituted for the term "gray water." Gray water recycling systems and rain water recycling systems shall be separate systems and shall not be interconnected.~~

~~36. 33. Add Section R329 Fire Extinguishers.~~

~~37. 34. Add Section R329.1 to read:~~

~~R329.1 Kitchen areas. Other than where the dwelling is equipped with an approved sprinkler system in accordance with Section R313, a fire extinguisher having a rating of 2-A:10-B:C or an approved equivalent type of fire extinguisher shall be installed in the kitchen area.~~

~~38. 35. Change Section R401.3 to read:~~

~~R401.3 Drainage. Surface drainage shall be diverted to a storm sewer conveyance or other approved point of collection that does not create a hazard to the dwelling unit. Lots shall be graded to drain surface water away from foundation walls. The grade shall fall a minimum of six inches (152 mm) within the first 10 feet (3048 mm).~~

~~Exception: Where lot lines, walls, slopes or other physical barriers prohibit six inches (152 mm) of fall within 10 feet (3048 mm), drains or swales shall be constructed to ensure drainage away from the structure. Impervious surfaces within 10 feet (3048 mm) of the building foundation shall be sloped a minimum of 2.0% away from the building.~~

~~39. 36. Change Section R403.1 to read:~~

~~R403.1 General. All exterior walls shall be supported on continuous solid or fully grouted masonry or concrete footings, wood foundations, or other approved structural systems ~~which~~ that shall be of sufficient design to accommodate all loads according to Section R301 and to transmit the resulting loads to the soil within the limitations as determined from the character of the soil. Footings shall be supported on undisturbed natural soils or engineered fill.~~

~~Exception: One-story detached accessory structures used as tool and storage sheds, playhouses and similar uses, not exceeding 256 square feet (23.7824 m²) of building area, provided all of the following conditions are met:~~

- ~~1. The building eave height is 10 feet or less.~~
- ~~2. The maximum height from the finished floor level to grade does not exceed 18 inches.~~
- ~~3. The supporting structural elements in direct contact with the ground shall be placed level on firm soil and~~

when such elements are wood they shall be approved pressure preservative treated suitable for ground contact use.

4. The structure is anchored to withstand wind loads as required by this code.

5. The structure shall be of light-frame construction whose vertical and horizontal structural elements are primarily formed by a system of repetitive wood or light gauge steel framing members, with walls and roof of light weight material, not slate, tile, brick or masonry.

~~40. Change Exceptions 2 and 3 in Section R403.1.6 to read:~~

~~2. Walls 24 inches (610 mm) total length or shorter connecting offset braced wall panels shall be anchored to the foundation with a minimum of one anchor bolt located in the center third of the plate section.~~

~~3. Connection of walls 12 inches (305 mm) total length or shorter connecting offset braced wall panels to the foundation without anchor bolts shall be permitted.~~

~~41. Delete Item 5 of Section R403.1.6.1.~~

~~42. 37. Add Section R408.3.1 to read:~~

~~R408.3.1 Termite inspection. Where an unvented crawl space is installed and meets the criteria in Section R408, the vertical face of the sill plate shall be clear and unobstructed and an inspection gap shall be provided below the sill plate along the top of any interior foundation wall covering. The gap shall be a minimum of one inch (25.4 mm) and a maximum of two inches (50.8 mm) in width and shall extend throughout all parts of any foundation that is enclosed. Joints between the sill plate and the top of any interior wall covering may be sealed.~~

~~Exceptions:~~

~~1. In areas not subject to damage by termites as indicated by Table R301.2(1).~~

~~2. Where other approved means are provided to inspect for potential damage.~~

~~Where pier and curtain foundations are installed as depicted in Figure R404.1.5(1), the inside face of the rim joist and sill plate shall be clear and unobstructed except for construction joints which may be sealed.~~

~~Exception: Fiberglass or similar insulation may be installed if easily removable.~~

~~43. Change Section R502.2.1 to read:~~



~~R502.2.1 Framing at braced wall panels. A load path for lateral forces shall be provided between floor framing and braced wall panels located above or below a floor, as specified in Sections R602.3.5 and R602.10.8.~~

~~38. Change Section R502.5 and add Table R502.5(3) to read:~~

~~R502.5 Allowable girder and header spans. The allowable spans of girders and headers fabricated of~~

Regulations

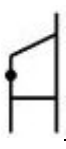
dimension lumber shall not exceed the values set forth in Tables R502.5(1) through R502.5(3).

Table R502.5(3) Girder and Header Spans for Porches ^{a,b} (Maximum span for southern pine)			
Header Supporting	Header Size	Porch Width (ft)	
		8	14
 Roof	2-2x4	6'-11"	5'-3"
	2-2x6	9'-11"	7'-6"
	2-2x8	12'-10"	9'-8"
	2-2x10	16'-8"	12'-7"
	2-2x12	19'-6"	14'-9"
 Floor	2-2x4	5'-1"	3'-10"
	2-2x6	7'-4"	5'-6"
	2-2x8	9'-5"	7'-1"
	2-2x10	12'-2"	9'-3"
	2-2x12	14'-4"	10'-10"

For SI: 1 inch = 25.4 mm, 1 foot = 304.8 mm.
 a. Tabulated values based on 30 psf ground snow load, L/240 deflection and #2 grade lumber.
 b. The values of this table shall be equivalent to a roof live load of 20 psf.

44. 39. Change Section R506.2.1 to read:

R506.2.1 Fill. Fill material shall be free of vegetation and foreign material and shall be natural nonorganic material that is not susceptible to swelling when exposed to moisture. The fill shall be compacted to assure uniform support of the slab, and except where approved, the fill depth shall not exceed 24 inches (610 mm) for clean sand or gravel and 8 inches (203 mm) for earth.

Exception: Material other than natural material may be used as fill material when accompanied by a certification from an RDP and approved by the building official.

45. 40. Change Section R506.2.2 to read:

R506.2.2 Base. A 4-inch-thick (102 mm) base course consisting of clean graded sand, gravel or crushed stone passing a 2-inch (51 mm) sieve shall be placed on the prepared subgrade when the slab is below grade.

Exception: A base course is not required when the concrete slab is installed on well drained or sand-gravel mixture soils classified as Group I according to the United Soil Classification System in accordance with Table R405.1. Material other than natural material may be used as base course material when accompanied by a

certification from an RDP and approved by the building official.

46. ~~Modify Table R602.3(1) to change and add items as shown:~~

7	Built up studs, face nail	10d (3"x0.128")	24" o.c.
7a	Abutting studs at intersecting wall corners, face nail	16d (3½"x0.135")	12" o.c.
26a	Rim joist or blocking to sill plate, toe nail	8d (2½"x0.113")	6" o.c.

47. Add Section R602.3.5 to read:

~~R602.3.5 Braced wall panel uplift load path. Braced wall panels located at exterior walls that support roof rafters or trusses (including stories below top story) shall have the framing members connected in accordance with one of the following:~~

1. Fastening in accordance with Table R602.3(1) where:

1.1. The basic wind speed does not exceed 90 mph (40 m/s), the wind exposure category is B, the roof pitch is 5:12 or greater, and the roof span is 32 feet (9754 mm) or less, or

1.2. The net uplift value at the top of a wall does not exceed 100 plf (146 N/mm). The net uplift value shall be determined in accordance with Section R802.11 and shall be permitted to be reduced by 60 plf (57 N/mm) for each full wall above.

2. Where the net uplift value at the top of a wall exceeds 100 plf (146 N/mm), installing approved uplift framing connectors to provide a continuous load path from the top of the wall to the foundation or to a point where the uplift force is 100 plf (146 N/mm) or less. The net uplift value shall be as determined in Item 1.2 above.

3. Wall sheathing and fasteners designed in accordance with accepted engineering practice to resist combined uplift and shear forces.

41. Change Figure R602.3(2) to read:

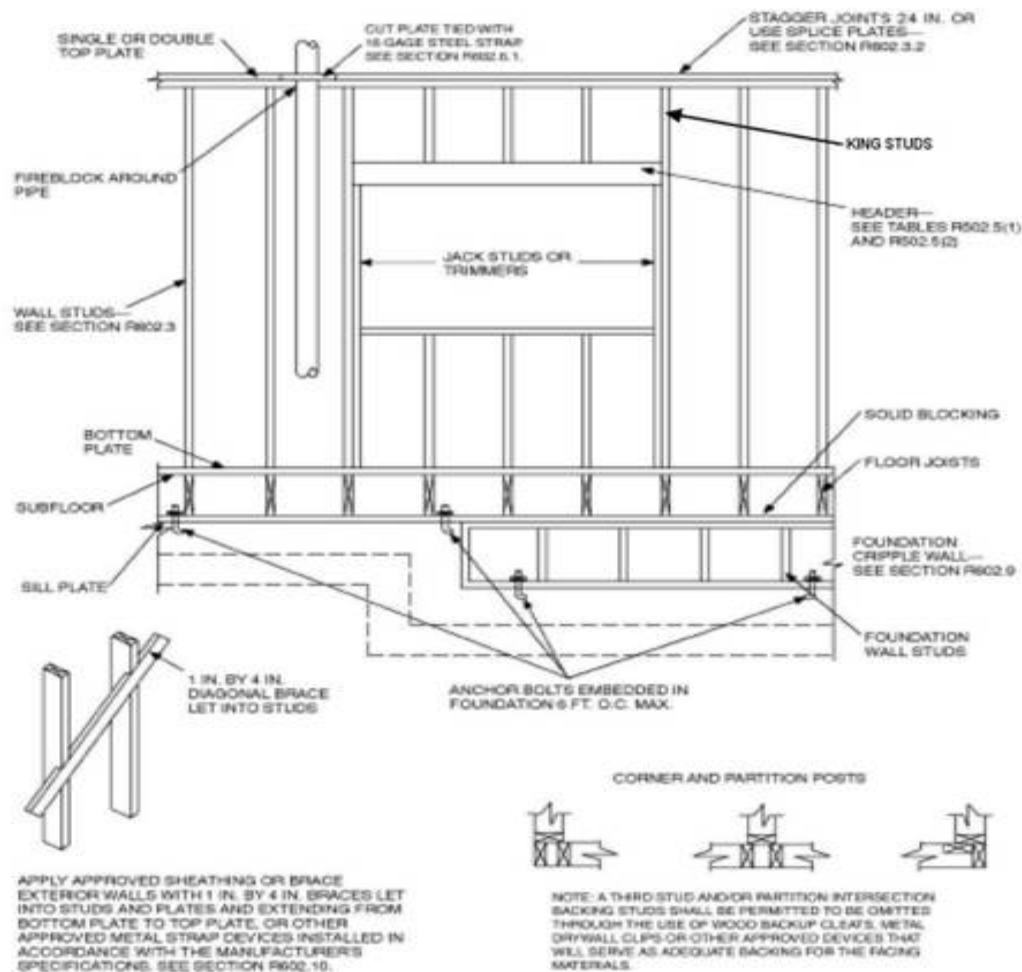

For SI: 1 inch = 25.4 mm, 1 foot = 304.8 mm.

FIGURE R602.3(2)
FRAMING DETAILS

42. Add Section R602.7.4 to read:

R602.7.4 Supports for headers. Headers shall be supported on each end with one or more jack studs in accordance with Table R505.5(1) or Table R502.5(2). A king stud shall be adjacent to the jack stud on each end of the header and nailed at each end of the header with 4-12d nails.

48. Change Section R602.9 to read:

~~R602.9 Cripple walls.~~ Foundation cripple walls shall be framed of studs not smaller than the studding above. When exceeding four feet (1219 mm) in height, such walls shall be framed of studs having the size required for an additional story.

~~Cripple walls with a stud height less than 14 inches (356 mm) shall be continuously sheathed on one side with wood structural panels fastened to both the top and bottom plates in accordance with Table R602.3(1), or the cripple walls shall be constructed of solid blocking. Cripple walls shall be supported on continuous foundations.~~

49. Replace Section R602.10, including all subsections, with the following:

~~R602.10 Wall bracing.~~ Buildings shall be braced in accordance with this section or, when applicable, Section R602.12. Where a building, or portion thereof, does not comply with one or more of the bracing requirements in this section, those portions shall be designed and constructed in accordance with Section R301.1.

Regulations

The building official may require the permit applicant to identify and locate on the construction documents braced wall lines and braced wall panels as described herein.

R602.10.1 Braced wall lines. For the purpose of determining the amount and location of bracing required in each story level of a building, braced wall lines shall be designated as straight lines in the building plan placed in accordance with this section.

R602.10.1.1 Length of a braced wall line. The length of a braced wall line shall be the distance between its ends. The end of a braced wall line shall be the intersection with a perpendicular braced wall line, an angled braced wall line as permitted in Section R602.10.1.4 or an exterior wall as shown in Figure R602.10.1.1.

Editor's Note - Figures R602.10.1.1, R602.10.1.4, R602.10.2.2, R602.10.5, R602.10.6.1, R602.10.6.2, R602.10.6.3, R602.10.6.4, R602.10.7, R602.10.8(1), R602.10.8(2), R602.10.8.1(1), R602.10.8.1(2), R602.10.8.1(3), R602.10.9, R602.10.12.1, and R602.10.12.5 in this section shown below this note are being stricken in the final action.

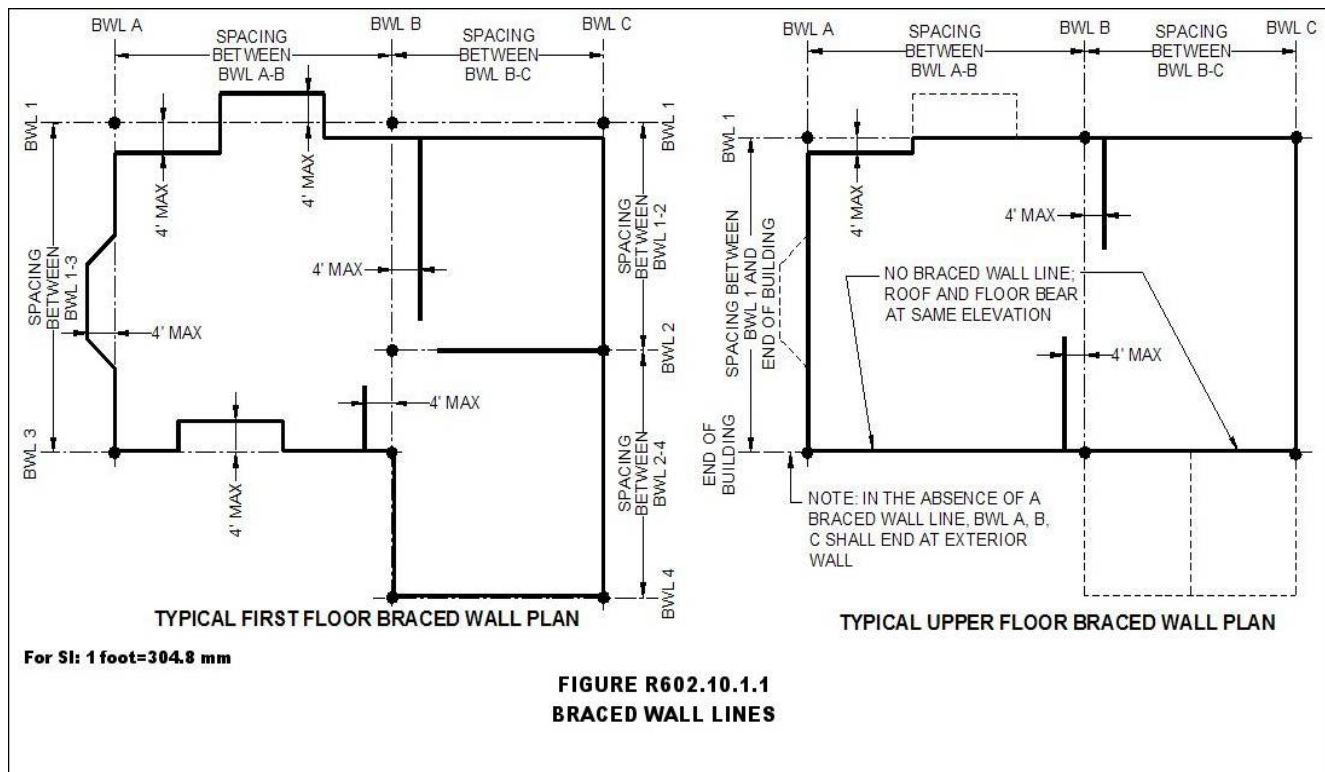

R602.10.1.2 Offsets along a braced wall line. All exterior walls parallel to a braced wall line shall be permitted to offset up to four feet (1219 mm) from the designated braced wall line location as shown Figure R602.10.1.1. Interior walls used as bracing shall be permitted to offset up to four feet (1219 mm) from a braced wall line through the interior of the building as shown in Figure R602.10.1.1.

R602.10.1.3 Spacing of braced wall lines. There shall be a minimum of two braced wall lines in both the longitudinal and transverse direction as shown in Figure R602.10.1.1. Intermediate braced wall lines through the interior of the building shall be permitted. The spacing between parallel braced wall lines shall be in accordance with Table R602.10.1.3.

Table R602.10.1.3 Braced Wall Line Spacing				
APPLICATION	CONDITION	BUILDING TYPE	BRACED WALL LINE SPACING CRITERIA	
			Maximum Spacing	Exception to Maximum Spacing

Wind bracing	85 mph to <110 mph	Detached, townhouse	60 feet	None
Seismic bracing	SDC A-C	Detached	Use wind bracing	
	SDC A-B	Townhouse	Use wind bracing	
	SDC C	Townhouse	35 feet	Up to 50 feet when length of required bracing per Table R602.10.3(3) is adjusted in accordance with Table R602.10.3(4)
For SI: 1 foot=304.8 mm				

R602.10.1.4 Angled walls. Any portion of a wall along a braced wall line shall be permitted to angle out of plane for a maximum diagonal length of eight feet (2438 mm). Where the angled wall occurs at a corner, the length of the braced wall line shall be measured from the projected corner as shown in Figure R602.10.1.4. Where the diagonal length is greater than eight feet (2438 mm), it shall be considered a separate braced wall line and shall be braced in accordance with Section R602.10.1.

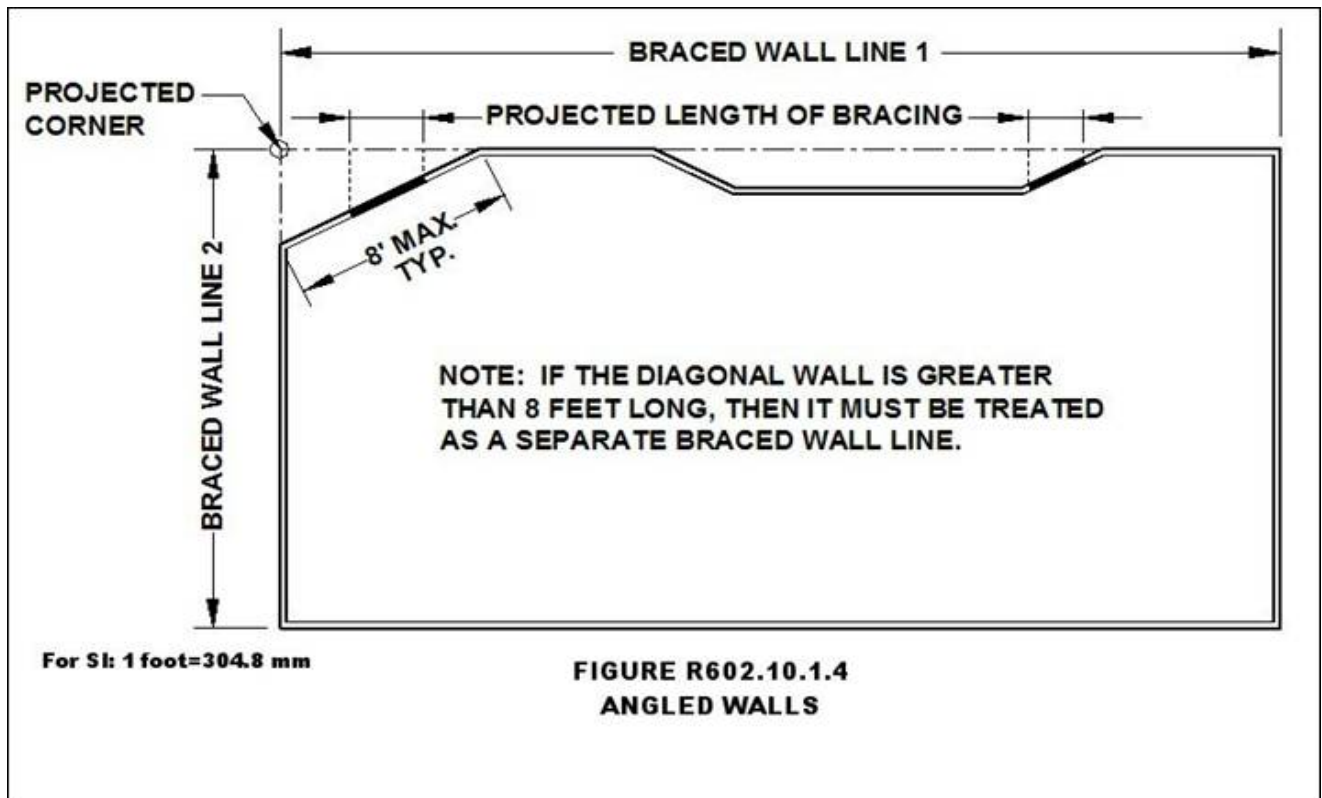

R602.10.2 Braced wall panels. Braced wall panels shall be full height sections of wall that shall have no vertical or horizontal offsets. Braced wall panels shall be constructed and placed along a braced wall line in accordance with this section and the bracing methods specified in Section R602.10.4.

R602.10.2.1 Braced wall panel uplift load path. The bracing lengths in Table R602.10.3(1) apply only when uplift loads are resisted per Section R602.3.5.

R602.10.2.2 Locations of braced wall panels. A braced wall panel shall begin within 10 feet (3810 mm) from each end of a braced wall line as determined in accordance with Section R602.10.1.1. The distance between adjacent edges of braced wall panels along a braced wall line shall be no greater than 20 feet (6096 mm) as shown in Figure R602.10.2.2.

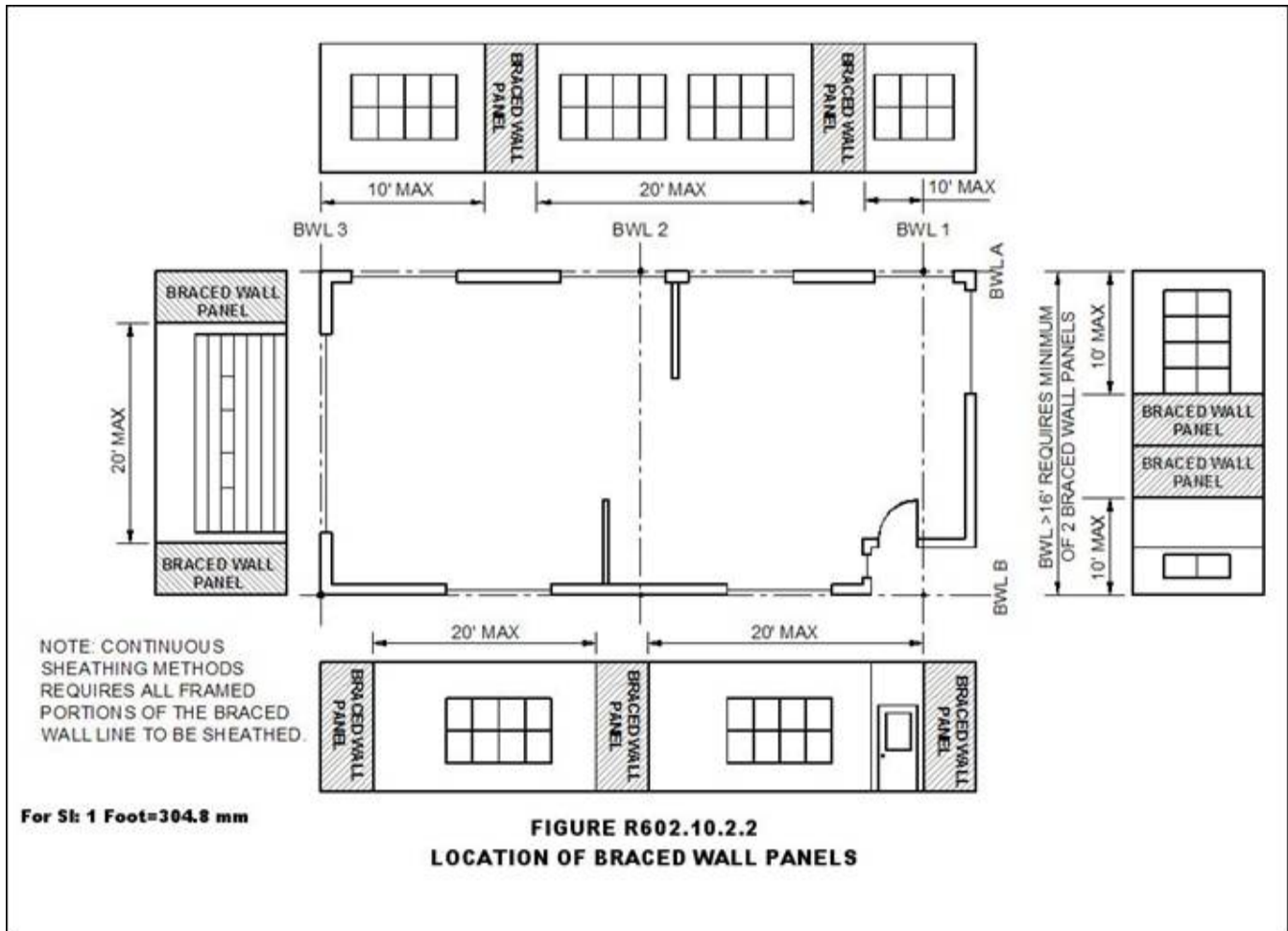





R602.10.2.3 Minimum number of braced wall panels. Braced wall lines with a length of 16 feet (4877 mm) or less shall have a minimum of two braced wall panels of any length or one braced wall panel equal to 48 inches (1219 mm) or more. Braced wall lines greater than 16 feet (4877 mm) shall have a minimum of two braced wall panels.

R602.10.3 Required length of bracing. The required length of bracing along each braced wall line shall be determined as follows:

1. All buildings in Seismic Design Categories A and B shall use Table R602.10.3(1) and the applicable adjustment factors in Table R602.10.3(2).
2. Detached buildings in Seismic Design Category C shall use Table R602.10.3(1) and the applicable adjustment factors in Table R602.10.3(2).
3. Townhouses in Seismic Design Category C shall use the greater value determined from Table R602.10.3(1) or R602.10.3(3) and the applicable adjustment factors in Table R602.10.3(2) or R602.10.3(4) respectively.

Only braced wall panels parallel to the braced wall line within the four foot (1219 mm) offset permitted by Section R602.10.1.2 shall contribute towards the required length of bracing of that braced wall line. If a braced wall panel is located along an angled wall and meets the minimum length requirements of Tables R602.10.5 or R602.10.5.2, it shall be permitted to contribute its projected length towards the minimum required length of bracing for the braced wall line as shown in Figure R602.10.1.4. If a braced wall panel is located along an angled wall at the end of a braced wall line, it shall contribute its projected length for only one of the braced wall lines at the projected corner.

Table R602.10.3(1)
Bracing Requirements Based on Wind Speed

EXPOSURE CATEGORY B 30 FT MEAN ROOF HEIGHT 10 FT EAVE TO RIDGE HEIGHT 10 FT WALL HEIGHT 2 BRACED WALL LINES		MINIMUM TOTAL LENGTH (FEET) OF BRACED WALL PANELS REQUIRED ALONG EACH BRACED WALL LINE ^a				
Basic Wind Speed (mph)	Story Location	Braced Wall Line Spacing (feet)	Method LIB ^b	Method GB	Methods DWB, WSP, SFB, PBS, PCP, HPS, CS-SFB ^c	Methods CS-WSP, CS-G, CS-PF
≤ 85		10	3.5	3.5	2.0	1.5
		20	6.0	6.0	3.5	3.0
		30	8.5	8.5	5.0	4.5
		40	11.5	11.5	6.5	5.5
		50	14.0	14.0	8.0	7.0
		60	16.5	16.5	9.5	8.0
		10	6.5	6.5	3.5	3.0
		20	11.5	11.5	6.5	5.5
		30	16.5	16.5	9.5	8.0
		40	21.5	21.5	12.5	10.5
		50	26.5	26.5	15.0	13.0
		60	31.5	31.5	18.0	15.5
		10	NP	9.0	5.5	4.5
		20	NP	17.0	10.0	8.5
		30	NP	24.5	14.0	12.0
		40	NP	32.0	18.0	15.5
		50	NP	39.0	22.5	19.0
		60	NP	46.5	26.5	22.5
≤ 90		10	3.5	3.5	2.0	2.0
		20	7.0	7.0	4.0	3.5
		30	9.5	9.5	5.5	5.0
		40	12.5	12.5	7.5	6.0
		50	15.5	15.5	9.0	7.5
		60	18.5	18.5	10.5	9.0
		10	7.0	7.0	4.0	3.5

Regulations

Table R602.10.3(1)
Bracing Requirements Based on Wind Speed







EXPOSURE CATEGORY B 30 FT MEAN ROOF HEIGHT 10 FT EAVE TO RIDGE HEIGHT 10 FT WALL HEIGHT 2 BRACED WALL LINES		MINIMUM TOTAL LENGTH (FEET) OF BRACED WALL PANELS REQUIRED ALONG EACH BRACED WALL LINE ^a				
Basic Wind Speed (mph)	Story Location	Braced Wall Line Spacing (feet)	Method LIB ^b	Method GB	Methods DWB, WSP, SFB, PBS, PCP, HPS, CS-SFB ^c	Methods CS-WSP, CS-G, CS-PF
		20	13.0	13.0	7.5	6.5
		30	18.5	18.5	10.5	9.0
		40	24.0	24.0	14.0	12.0
		50	29.5	29.5	17.0	14.5
		60	35.0	35.0	20.0	17.0
		10	NP	10.5	6.0	5.0
		20	NP	19.0	11.0	9.5
		30	NP	27.5	15.5	13.5
		40	NP	35.5	20.5	17.5
		50	NP	44.0	25.0	21.5
		60	NP	52.0	30.0	25.5
≤ 100		10	4.5	4.5	2.5	2.5
		20	8.5	8.5	5.0	4.0
		30	12.0	12.0	7.0	6.0
		40	15.5	15.5	9.0	7.5
		50	19.0	19.0	11.0	9.5
		60	22.5	22.5	13.0	11.0
		10	8.5	8.5	5.0	4.5
		20	16.0	16.0	9.0	8.0
		30	23.0	23.0	13.0	11.0
		40	29.5	29.5	17.0	14.5
		50	36.5	36.5	21.0	18.0
		60	43.5	43.5	25.0	21.0
		10	NP	12.5	7.5	6.0
		20	NP	23.5	13.5	11.5

Table R602.10.3(1)
Bracing Requirements Based on Wind Speed

EXPOSURE CATEGORY B 30 FT MEAN ROOF HEIGHT 10 FT EAVE TO RIDGE HEIGHT 10 FT WALL HEIGHT 2 BRACED WALL LINES		MINIMUM TOTAL LENGTH (FEET) OF BRACED WALL PANELS REQUIRED ALONG EACH BRACED WALL LINE ^a				
Basic Wind Speed (mph)	Story Location	Braced Wall Line Spacing (feet)	Method LIB ^b	Method GB	Methods DWB, WSP, SFB, PBS, PCP, HPS, CS-SFB ^c	Methods CS-WSP, CS-G, CS-PF
<110		30	NP	34.0	19.5	16.5
		40	NP	44.0	25.0	21.5
		50	NP	54.0	31.0	26.5
		60	NP	64.0	36.5	31.0
		10	5.5	5.5	3.0	3.0
		20	10.0	10.0	6.0	5.0
		30	14.5	14.5	8.5	7.0
		40	18.5	18.5	11.0	9.0
		50	23.0	23.0	13.0	11.5
		60	27.5	27.5	15.5	13.5
		10	10.5	10.5	6.0	5.0
		20	19.0	19.0	11.0	9.5
	30	27.5	27.5	16.0	13.5	
	40	36.0	36.0	20.5	17.5	
	50	44.0	44.0	25.5	21.5	
	60	52.5	52.5	30.0	25.5	
	10	0	15.5	9.0	7.5	
	20	NP	28.5	16.5	14.0	
	30	NP	41.0	23.5	20.0	
	40	NP	53.0	30.5	26.0	
	50	NP	65.5	37.5	32.0	
	60	NP	77.5	44.5	37.5	

Regulations

Table R602.10.3(1) Bracing Requirements Based on Wind Speed						
EXPOSURE CATEGORY B 30 FT MEAN ROOF HEIGHT 10 FT EAVE TO RIDGE HEIGHT 10 FT WALL HEIGHT 2 BRACED WALL LINES			MINIMUM TOTAL LENGTH (FEET) OF BRACED WALL PANELS REQUIRED ALONG EACH BRACED WALL LINE ^a			
Basic Wind Speed (mph)	Story Location	Braced Wall Line Spacing (feet)	Method LIB ^b	Method GB	Methods DWB, WSP, SFB, PBS, PCP, HPS, CS-SFB ^c	Methods CS-WSP, CS-G, CS-PF
For SI: 1 inch=25.4 mm, 1 foot=305 mm. ^a Linear interpolation shall be permitted. ^b Method LIB shall have gypsum board fastened to at least one side with nails or screws per Table R602.3(1) for exterior sheathing or Table R702.3.5 for interior gypsum board. Spacing of fasteners at panel edges shall not exceed eight inches (203 mm). ^c Method CS-SFB does not apply where the wind speed is greater than 100 mph.						

Table R602.10.3(2) Wind Adjustment Factors to the Required Length of Wall Bracing				
ADJUSTMENT BASED ON	STORY/ SUPPORTING	CONDITION	ADJUSTMENT FACTOR ^{a,b} (multiply length from Table R602.10.3(1) by this factor)	APPLICABLE METHODS
Exposure category	One-story structure	B	1.00	All methods
		C	1.20	
		D	1.50	
	Two-story structure	B	1.00	
		C	1.30	
		D	1.60	
	Three-story structure	B	1.00	
		C	1.40	
		D	1.70	
Roof eave to ridge height	Roof only	≤5 ft	0.70	
		10 ft	1.00	
		15 ft	1.30	
		20 ft	1.60	

	Roof + 1 floor	≤5 ft	0.85	
		10 ft	1.00	
		15 ft	1.15	
		20 ft	1.30	
	Roof + 2 floors	≤5 ft	0.90	
		10 ft	1.00	
		15 ft	1.10	
		20 ft	Not permitted	
Wall height adjustment	Any story	8 ft	0.90	
		9 ft	0.95	
		10 ft	1.00	
		11 ft	1.05	
		12 ft	1.10	
Number of braced wall lines (per plan direction) ^e	Any story	2	1.00	
		3	1.30	
		4	1.45	
		≥5	1.60	
Additional 800-lb hold-down device	Top story only	Fastened to the end studs of each braced wall panel and to the foundation or framing below	0.80	DWB, WSP, SFB, PBS, PCP, HPS
Interior gypsum board finish (or equivalent)	Any story	Omitted from inside face of braced wall panels	1.40	DWB, WSP, SFB, PBS, PCP, HPS, CS-WSP, CS-G, CS-SFB
Gypsum board fastening	Any story	4 in. o.c. at panel edges, including top and bottom plates, and all horizontal joints blocked	0.7	GB

For SI: 1 foot=305 mm, 1 lb=4.48 N.



^aLinear interpolation shall be permitted.

^bThe total adjustment factor is the product of all applicable adjustment factors.

^cThe adjustment factor is permitted to be 1.0 when determining bracing amounts of intermediate braced wall lines provided the bracing amounts on adjacent braced wall lines are based on a spacing and number that neglects the intermediate braced wall line.

Regulations

Table R602.10.3(3)
Bracing Requirements Based on Seismic Design Category



SOIL CLASS D ^b WALL HEIGHT = 10 FT 10 PSF FLOOR DEAD LOAD 15 PSF ROOF/CEILING DEAD LOAD BRACED WALL LINE SPACING ≤ 25 FT		MINIMUM TOTAL LENGTH (FEET) OF BRACED WALL PANELS REQUIRED ALONG EACH BRACED WALL LINE ^a					
Seismic Design Category	Story Location	Braced Wall Line Length (ft)	Method LIB ^c	Method GB	Methods DWB, SFB, PBS, PCP, HPS, CS-SFB	Method WSP	Methods CS-WSP, CS-G
C (townhouses only)		10	2.5	2.5	2.5	1.6	1.4
		20	5.0	5.0	5.0	3.2	2.7
		30	7.5	7.5	7.5	4.8	4.1
		40	10.0	10.0	10.0	6.4	5.4
		50	12.5	12.5	12.5	8.0	6.8
		10	NP	4.5	4.5	3.0	2.6
		20	NP	9.0	9.0	6.0	5.1
		30	NP	13.5	13.5	9.0	7.7
		40	NP	18.0	18.0	12.0	10.2
		50	NP	22.5	22.5	15.0	12.8
		10	NP	6.0	6.0	4.5	3.8
		20	NP	12.0	12.0	9.0	7.7
		30	NP	18.0	18.0	13.5	11.5
		40	NP	24.0	24.0	18.0	15.3
		50	NP	30.0	30.0	22.5	19.1

For SI: 1 foot=305 mm

^aLinear interpolation shall be permitted.

^bWall bracing lengths are based on a soil-site class "D." Interpolation of bracing length between the S_{ds} values associated with the Seismic Design Categories shall be permitted when a site-specific S_{ds} value is determined in accordance with Section 1613.5 of the International Building Code.

^cMethod LIB shall have gypsum board fastened to at least one side with nails or screws per Table R602.3(1) for exterior sheathing or Table R702.3.5 for interior gypsum board. Spacing of fasteners at panel edges shall not exceed eight inches (203 mm).

Table R602.10.3(4) Seismic Adjustment Factors to the Required Length of Wall Bracing				
ADJUSTMENT BASED ON:	STORY/SUPPORTING	CONDITION	ADJUSTMENT FACTOR ^{a,b} (multiply length from Table R602.10.3(3) by this factor)	APPLICABLE METHODS
Story height (Section 301.3)	Any story	≤10 ft	1.0	All methods
		>10 ft ≤ 12 ft	1.2	
Braced wall line spacing	Any story	≤35 ft	1.0	
		>35 ft ≤ 50 ft	1.43	
Wall dead load	Any story	> 8 psf < 15 psf	1.0	
		<8 psf	0.85	
Roof/ceiling dead load for wall supporting	Any story	≤15 psf	1.0	
	Roof plus one or two stories	>15 psf ≤ 25 psf	1.1	
	Roof only	>15 psf ≤ 25 psf	1.2	
Walls with stone or masonry veneer ^c			1.0	
			1.5	
			1.5	
Interior gypsum board finish (or equivalent)	Any story	Omitted from inside face of braced wall panels	1.5	DWB, WSP, SFB, PBS, PCP, HPS, CS-WSP, CS-G, CS-SFB

For SI: 1 psf=47.8 N/m².

^aLinear interpolation shall be permitted.







^bThe total length of bracing required for a given wall line is the product of all applicable adjustment factors.





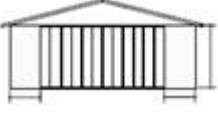

^cThe length to width ratio for the floor/roof diaphragm shall not exceed 3:1. The top plate lap splice nailing shall be a minimum of 12 16d nails on each side of the splice.

R602.10.4 Bracing methods for braced wall panels. Braced wall panels shall be constructed in accordance with this section and the methods listed in Table R602.10.4.

Regulations

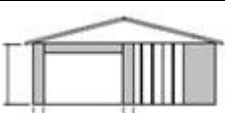
Table R602.10.4
Bracing Methods

METHODS, MATERIAL		MINIMUM THICKNESS	FIGURE	CONNECTION CRITERIA ^a	
				Fasteners	Spacing
Intermittent Bracing Methods	LIB Let-in bracing	1x4 wood or approved metal straps at 45° to 60° angles for maximum 16" stud spacing		Wood: 2-8d common nails or 3-8d (2 1/2" long x 0.113" dia.) nails Metal: per manufacturer	Wood: per stud and top and bottom plates Metal: per manufacturer
	DWB Diagonal wood boards	3/4" (1" nominal) for maximum 24" stud spacing		2-8d (2 1/2" long x 0.113" dia.) nails or 2-1 3/4" long staples	Per stud
	WSP Wood structural panel (See Section R604)	3/8"		Exterior sheathing per Table R602.3(3)	6" edges 12" field
				Interior sheathing per Table R602.3(1) or R602.3(2)	Varies by fastener
	SFB Structural fiberboard sheathing	1/2" or 25/32" for maximum 16" stud spacing		1 1/2" long x 0.12" dia. (for 1/2" thick sheathing) 1 3/4" long x 0.12" dia. (for 25/32" thick sheathing) galvanized roofing nails or 8d common (2 1/2" long x 0.131" dia.) nails	3" edges 6" field
	GB Gypsum board	1/2"		Nails or screws per Table R602.3(1) for exterior locations	For all braced wall panel locations: 7" edges (including top and bottom plates) 7" field
				Nails or screws per Table R702.3.5 for interior locations	
	PBS Particleboard sheathing (See Section R605)	3/8" or 1/2" for maximum 16" stud spacing		For 3/8", 6d common (2" long x 0.113" dia.) nails For 1/2", 8d common (2 1/2" long x 0.131" dia.) nails	3" edges 6" field
PCP Portland cement plaster	See Section R703.6 for maximum 16" stud spacing		1 1/2" long, 11-gage, 7/16" dia. head nails or 7/8" long, 16-gage	6" o.c. on all framing members	

				staples	
	HPS Hardboard panel siding	$\frac{7}{16}$ " for maximum 16" stud spacing		0.092" dia., 0.225" dia. head nails with length to accommodate 1½" penetration into studs	4" edges 8" field
	ABW Alternate braced wall	$\frac{3}{8}$ "		See Section R602.10.6.1	See Section R602.10.6.1
	PFH Portal frame with hold-downs	$\frac{3}{8}$ "		See Section R602.10.6.2	See Section R602.10.6.2
	PFG Portal frame at garage	$\frac{7}{16}$ "		See Section R602.10.6.3	See Section R602.10.6.3
Continuous Sheathing Methods	CS-WSP Continuously sheathed wood structural panel	$\frac{3}{8}$ "		Exterior sheathing per Table R602.3(3)	6" edges 12" field
				Interior sheathing per Table R602.3(1) or R602.3(2)	Varies by fastener
	CS-G ^{b,e} Continuously sheathed wood structural panel adjacent to garage openings	$\frac{3}{8}$ "		See Method CS-WSP	See Method CS-WSP
	CS-PF Continuously sheathed portal frame	$\frac{7}{16}$ "		See Section R602.10.6.4	See Section R602.10.6.4
	CS-SFB ^d Continuously sheathed structural fiberboard	$\frac{1}{2}$ " or $\frac{25}{32}$ " for maximum 16" stud spacing		1½" long x 0.12" dia. (for ½" thick sheathing) 1 ³ / ₄ " long x 0.12" dia. (for ²⁵ / ₃₂ " thick sheathing) galvanized roofing nails or 8d common (2½" long x 0.131 dia.) nails	3" edges 6" field

For SI: 1 inch = 25.4 mm, 1 foot = 305 mm.

^aAdhesive attachment of wall sheathing, including Method GB, shall not be permitted in townhouses in Seismic Design Category C.

^bApplies to panels next to garage door opening when supporting gable end wall or roof load only. May only be used on one

Regulations

wall of the garage.

^eGarage openings adjacent to a Method CS-G panel shall be provided with a header in accordance with Table R502.5(1). A full height clear opening shall not be permitted adjacent to a Method CS-G panel.

^dMethod CS-SFB does not apply in areas where the wind speed exceeds 100 mph.

R602.10.4.1 Mixing methods. Mixing of bracing methods shall be permitted as follows:

1. Mixing intermittent bracing and continuous sheathing methods from story to story shall be permitted.
2. Mixing intermittent bracing methods from braced wall line to braced wall line within a story shall be permitted. In regions where the basic wind speed is less than or equal to 100 mph, mixing of intermittent bracing and continuous sheathing methods from braced wall line to braced wall line within a story shall be permitted.
3. Mixing intermittent bracing methods along a braced wall line shall be permitted in Seismic Design Categories A and B, and detached dwellings in Seismic Design Category C provided the length of required bracing in accordance with Table R602.10.3(1) or R602.10.3(3) is the highest value of all intermittent bracing methods used.
4. Mixing of continuous sheathing methods CS-WSP, CS-G and CS-PF along a braced wall line shall be permitted.
5. In Seismic Design Categories A and B, and for detached one family and two family dwellings in Seismic Design Category C, mixing of intermittent bracing methods along the interior portion of a braced wall line with continuous sheathing methods CS-WSP, CS-G and CS-PF along the exterior portion of the same braced wall line shall be permitted. The length of required bracing shall be the highest value of all intermittent bracing methods used in accordance with Table R602.10.3(1) or R602.10.3(3) as adjusted by Tables R602.10.3(2) and R602.10.3(4), respectively. The requirements of Section R602.10.7 shall apply to each end of the continuously sheathed portion of the braced wall line.

R602.10.4.2 Continuous sheathing methods. Continuous sheathing methods require structural panel sheathing to be used on all sheathable surfaces on one side of a braced wall line including areas above and below openings and gable end walls and shall meet the requirements of Section R602.10.7.

R602.10.4.3 Braced wall panel interior finish material. Braced wall panels shall have gypsum wall board installed on the side of the wall opposite the bracing material. Gypsum wall board shall be not less than 1/2 inch (12.7 mm) in thickness and be fastened with nails or screws in accordance with Table R602.3(1) for exterior sheathing or Table R702.3.5 for interior gypsum wall board. Spacing of fasteners at panel edges for gypsum wall board opposite Method LIB bracing shall not exceed eight inches (203 mm). Interior finish material shall not be glued in townhouses in Seismic Category C.

Exceptions:

1. Interior finish material is not required opposite wall panels that are braced in accordance with Method GB, ABW, PFH, PFG and CS-PF, unless otherwise required by Section R302.6.
2. An approved interior finish material with an in-plane shear resistance equivalent to gypsum board shall be permitted to be substituted, unless otherwise required by Section R302.6.
3. Except for Method LIB, gypsum wall board is permitted to be omitted provided the required length of bracing in Tables R602.10.3(1) and R602.10.3(3) is multiplied by the appropriate adjustment factor in Tables R602.10.3(2) and R602.10.3(4) respectively, unless otherwise required by Section R302.6.

R602.10.5 Minimum length of a braced wall panel. The minimum length of a braced wall panel shall comply with Table R602.10.5. For Methods CS-WSP and CS-SFB, the minimum panel length shall be based on the vertical dimension of the adjacent opening in accordance with Table R602.10.5 and Figure R602.10.5. When a panel has openings on either side of differing heights, the larger vertical dimension shall be used to determine the minimum braced wall panel length.

R602.10.5.1 Contributing length. For purposes of complying with the required length of bracing in Tables R602.10.3(1) and R602.10.3(3), the contributing length of each braced wall panel to the total length of bracing shall be as specified in Table R602.10.5.

Table R602.10.5 Minimum Length of Braced Wall Panels							
METHOD (See Table R602.10.4)		MINIMUM LENGTH ^a (in)					CONTRIBUTING LENGTH (in)
		Wall Height					
		8 ft	9 ft	10 ft	11 ft	12 ft	
DWG, WSP, SFB, PBS, PCP, HPS		48	48	48	53	58	Actual ^b
GB		48	48	48	53	58	Double sided = Actual Single sided = 0.5 x Actual
LIB		55	62	69	NP	NP	Actual ^b
ABW		28	32	34	38	42	48
PFH	Supporting roof only	16	16	16	18 ^e	20 ^e	48
	Supporting one story and roof	24	24	24	27 ^e	29 ^e	48
PFG		24	27	30	33 ^e	36 ^e	1.5 x Actual ^b
CS-G		24	27	30	33	36	Actual ^b
CS-PF		16	18	20	22 ^e	24 ^e	Actual ^b
CS-WSP, CS-SFB	Adjacent opening vertical dimension (in)						
	≤64	24	27	30	33	36	Actual ^b
	68	26	27	30	33	36	
	72	27	27	30	33	36	
	76	30	29	30	33	36	
	80	32	30	30	33	36	
	84	35	32	32	33	36	
	88	38	35	33	33	36	
	92	43	37	35	35	36	
	96	48	41	38	36	36	
	100		44	40	38	38	
	104		49	43	40	39	
	108		54	46	43	41	
112			50	45	43		
116			55	48	45		

Regulations

120			60	52	48
124				56	51
128				61	54
132				66	58
136					62
140					66
144					72

For SI: 1 inch=25.4 mm

NP=Not permitted

^aLinear interpolation shall be permitted.

^bUse the actual length provided it is greater than or equal to the minimum length.

^cMaximum header height for is 10'; however, wall height may be increased to 12' with a pony wall per Table R602.10.6.4.

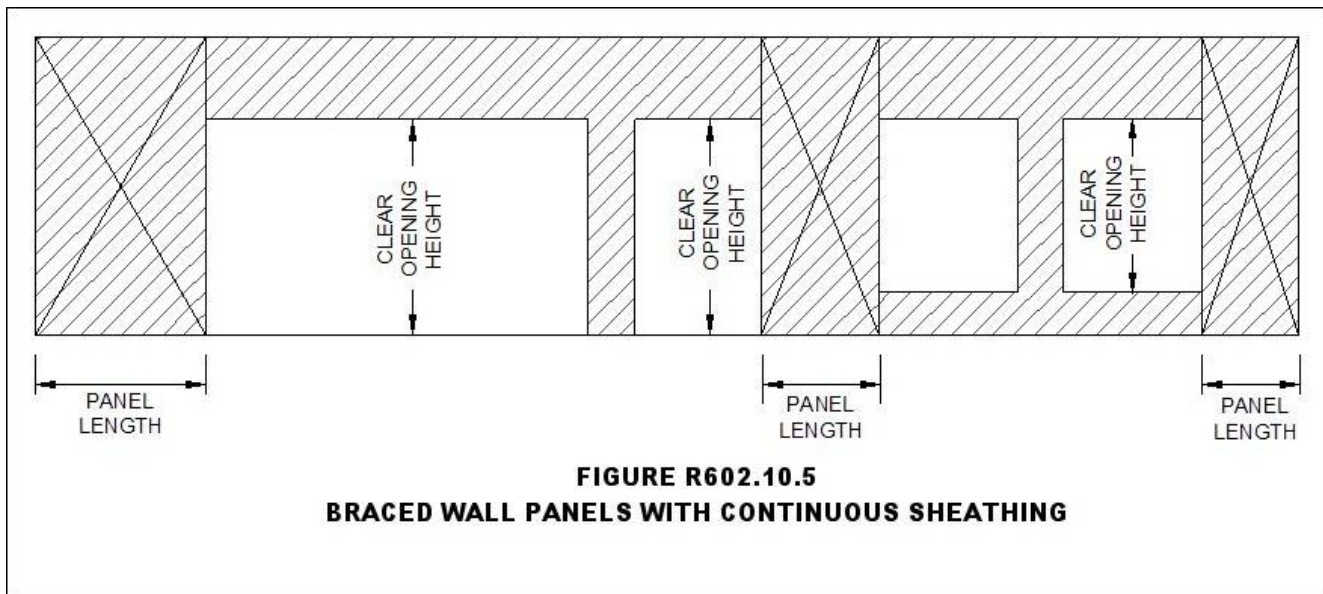

R602.10.5.2 Partial credit. For Methods DWB, WSP, SFB, PBS, PCP and HPS panels between 36 inches and 48 inches in length shall be considered a braced wall panel and shall be permitted to partially contribute towards the required length of bracing in Table R602.10.3(1) and R602.10.3(3), and the contributing length shall be determined from Table R602.10.5.2.

Actual Length of Braced Wall Panel (in)	Contributing Length of Braced Wall Panel (in) ^a	
	8 ft Wall Height	9 ft Wall Height
48	48	48
42	36	36
36	27	N/A

For SI: 1 inch=25.4mm

*Linear interpolation shall be permitted.

R602.10.6 Construction of Methods ABW, PFH, PFG and CS PF. Methods ABW, PFH, PFG and CS PF shall be constructed as specified in Sections R602.10.6.1 through R602.10.6.4.

R602.10.6.1 Method ABW: Alternate braced wall panels. Method ABW braced wall panels shall be constructed in accordance with Figure R602.10.6.1.

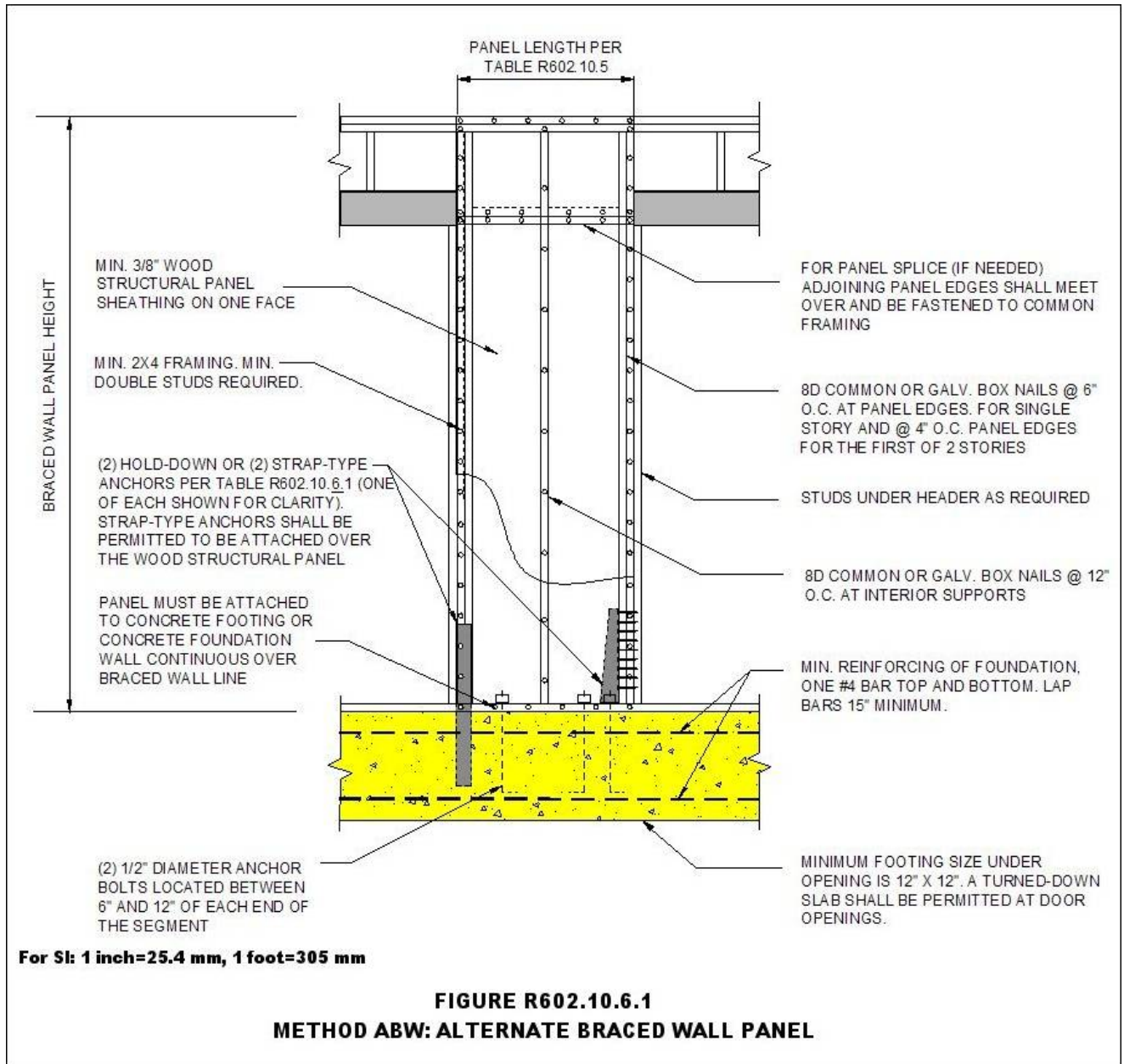

R602.10.6.2 Method PFH: Portal frame with hold downs. Method PFH braced wall panels shall be constructed in accordance with Figure R602.10.6.2.

Regulations

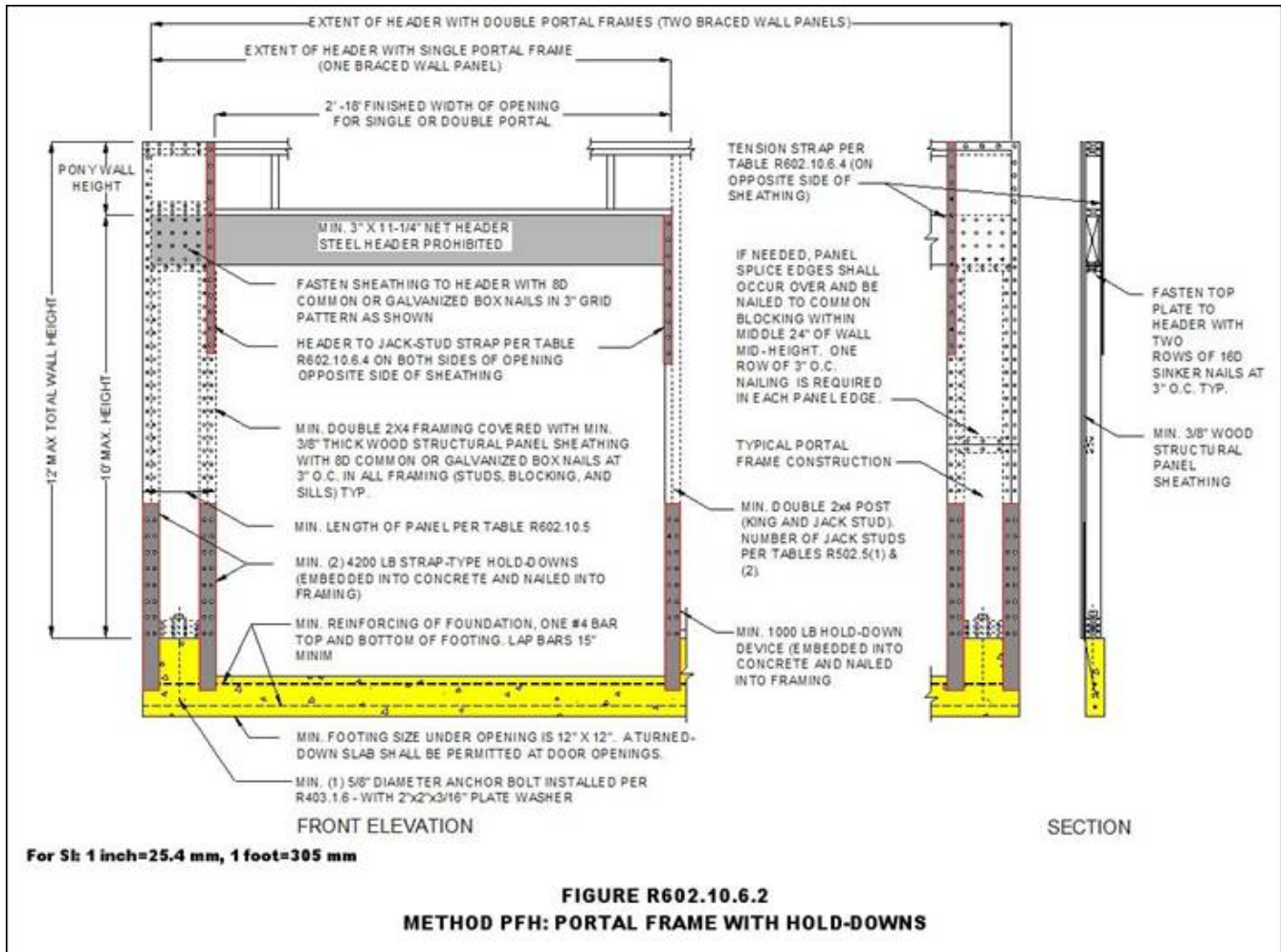

R602.10.6.3 Method PFG: Portal frame at garage door openings. Where supporting a roof or one story and a roof, a Method PFG braced wall panel constructed in accordance with Figure R602.10.6.3 shall be permitted on either side of garage door openings.

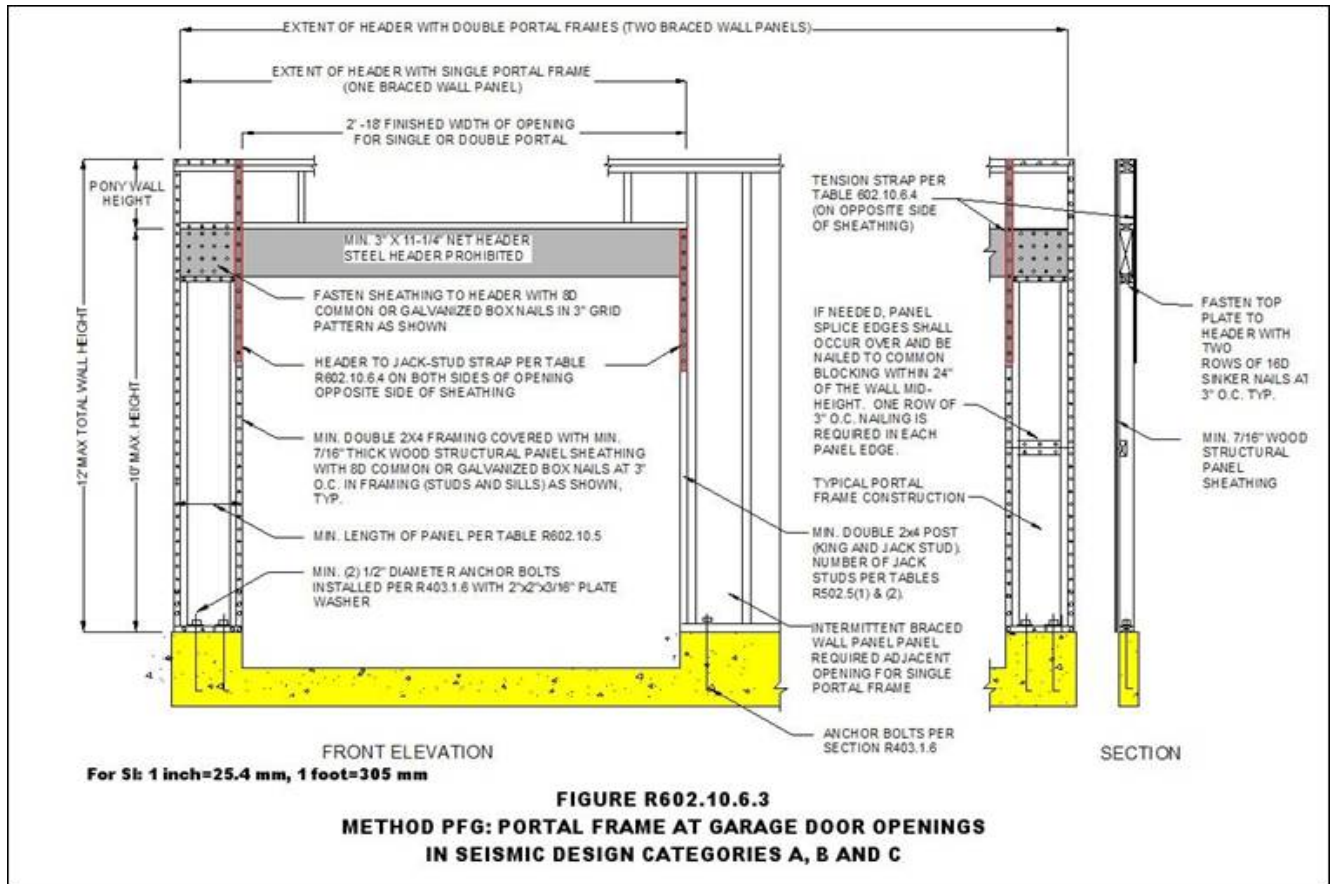

R602.10.6.4 Method CS PF: Continuously sheathed portal frame. Continuously sheathed portal frame braced wall panels shall be constructed in accordance with Figure R602.10.6.4 and Table R602.10.6.4. The number of continuously sheathed portal frame panels in a single braced wall line shall not exceed four.

Table R602.10.6.4
Tension Strap Capacity Required for Resisting Wind Pressures
Perpendicular to Method PFH, PFG and CS PF Braced Wall Panels

MINIMUM WALL STUD FRAMING NOMINAL SIZE AND GRADE	MAXIMUM PONY WALL HEIGHT (ft)	MAXIMUM TOTAL WALL HEIGHT (ft)	MAXIMUM OPENING WIDTH (ft)	TENSION STRAP CAPACITY REQUIRED (lb) ^a					
				Basic Wind Speed (mph)					
				85	90	100	85	90	100
				Exposure B			Exposure C		
2x4 No. 2 Grade	0	10	18	1000	1000	1000	1000	1000	1000
			9	1000	1000	1000	1000	1000	1275
			16	1000	1000	1750	1800	2325	3500
	1	10	18	1000	1200	2100	2175	2725	DR
			9	1000	1000	1025	1075	1550	2500
			16	1525	2025	3125	3200	3900	DR
	2	10	18	1875	2400	3575	3700	DR	DR
			9	1000	1200	2075	2125	2750	4000
			12	1000	1200	2075	2125	2750	4000

Regulations

	4	12	16	2600	3200	DR	DR	DR	DR
			18	3175	3850	DR	DR	DR	DR
			9	1775	2350	3500	3550	DR	DR
			16	4175	DR	DR	DR	DR	DR
2x6 Stud Grade	2	12	9	1000	1000	1325	1375	1750	2550
			16	1650	2050	2925	3000	3550	DR
			18	2025	2450	3425	3500	4100	DR
	4	12	9	1125	1500	2225	2275	2775	3800
			16	2650	3150	DR	DR	DR	DR
			18	3125	3675	DR	DR	DR	DR

For SI: 1 inch=25.4 mm, 1 foot=305 mm, 1 lb=4.45 N

DR = design required

*Strap shall be installed in accordance with manufacturer's recommendations.

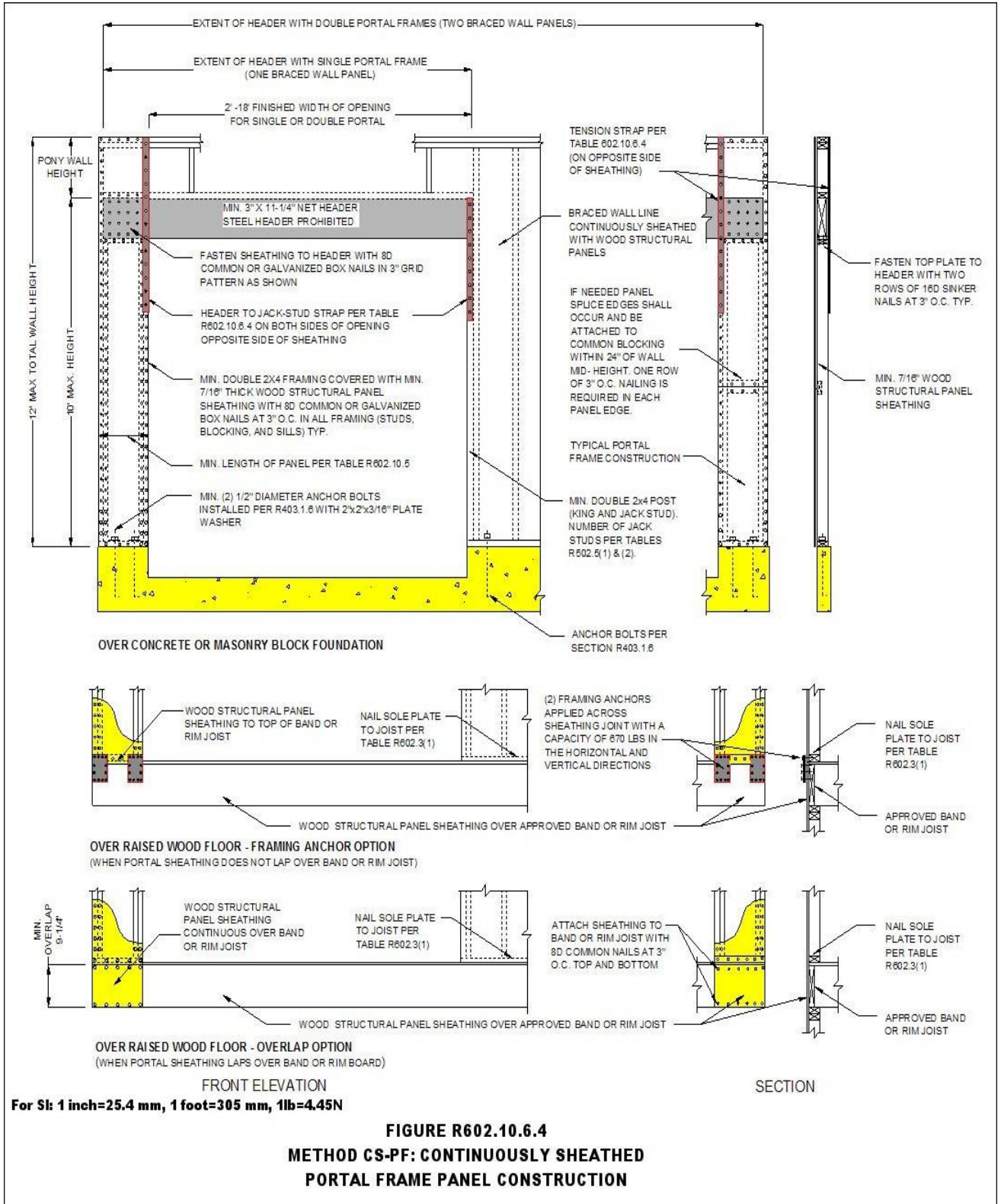

R602.10.7 Ends of braced wall lines with continuous sheathing. Each end of a braced wall line with continuous sheathing shall be in accordance with one of the end conditions shown in Figure R602.10.7.

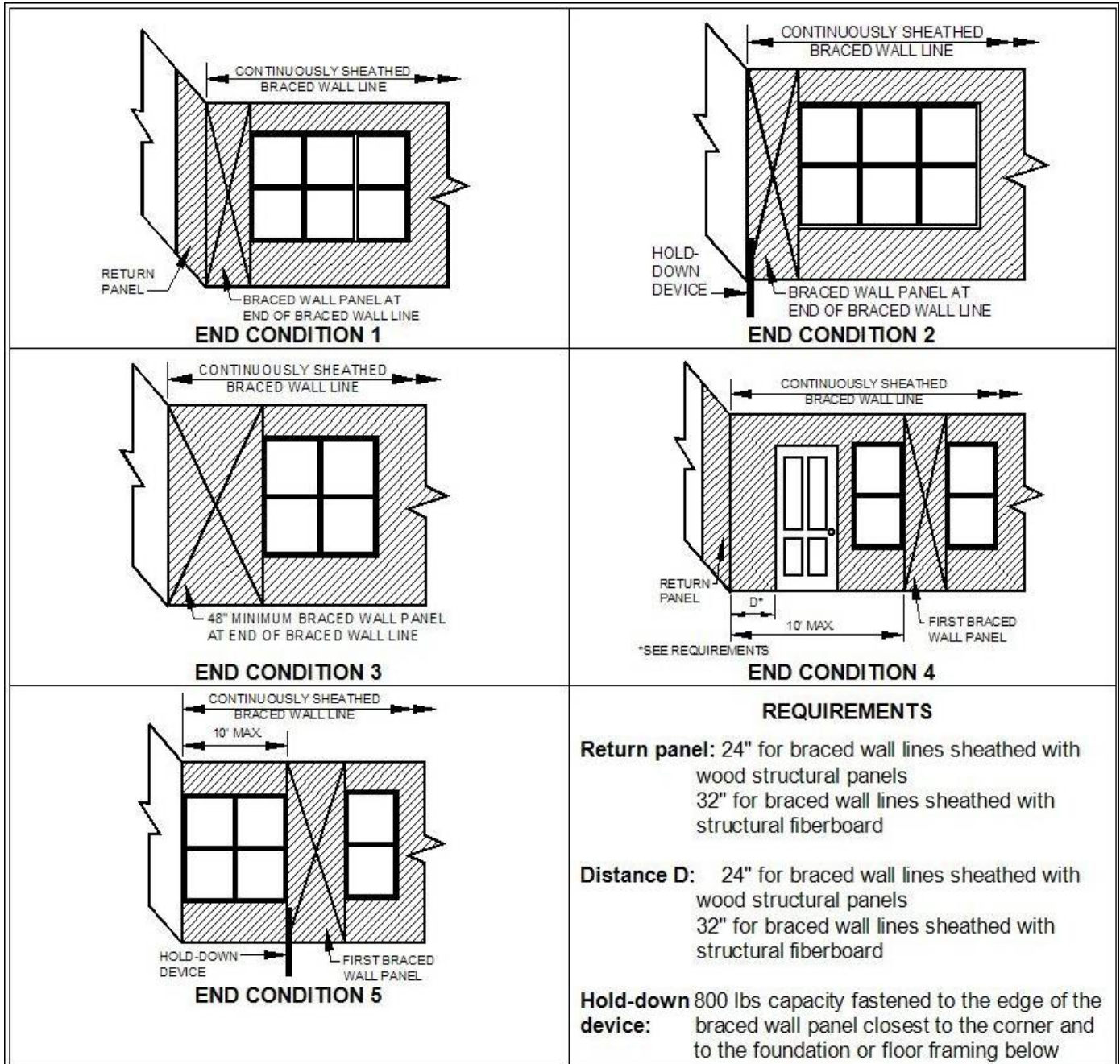

For SI: 1 inch=25.4 mm, 1 foot=305 mm, 1lb=4.45N

**FIGURE R602.10.7
END CONDITIONS FOR BRACED WALL LINES
WITH CONTINUOUS SHEATHING**

R602.10.8 Braced wall panel connections. Braced wall panels shall be connected to floor framing or foundations as follows:

1. Where joists are perpendicular to a braced wall panel above or below, a rim joist, band joist or blocking shall be provided along the entire length of the braced wall panel in accordance with Figure R602.10.8(1). Fastening of top and bottom wall plates to framing, rim joist, band joist and/or blocking shall be in accordance with Table R602.3(1).

2. Where joists are parallel to a braced wall panel above or below, a rim joist, end joist or other parallel framing member shall be provided directly above and below the braced wall panel in accordance with Figure R602.10.8(2). Where a parallel framing member cannot be located directly above and below the panel, full depth blocking at 16 inch (406 mm) spacing shall be provided between the parallel framing members to each side of the braced wall panel in accordance with Figure R602.10.8(2). Fastening of blocking and wall plates shall be in accordance with Table R602.3(1) and Figure R602.10.8(2).
3. Connections of braced wall panels to concrete or masonry shall be in accordance with Section R403.1.6.

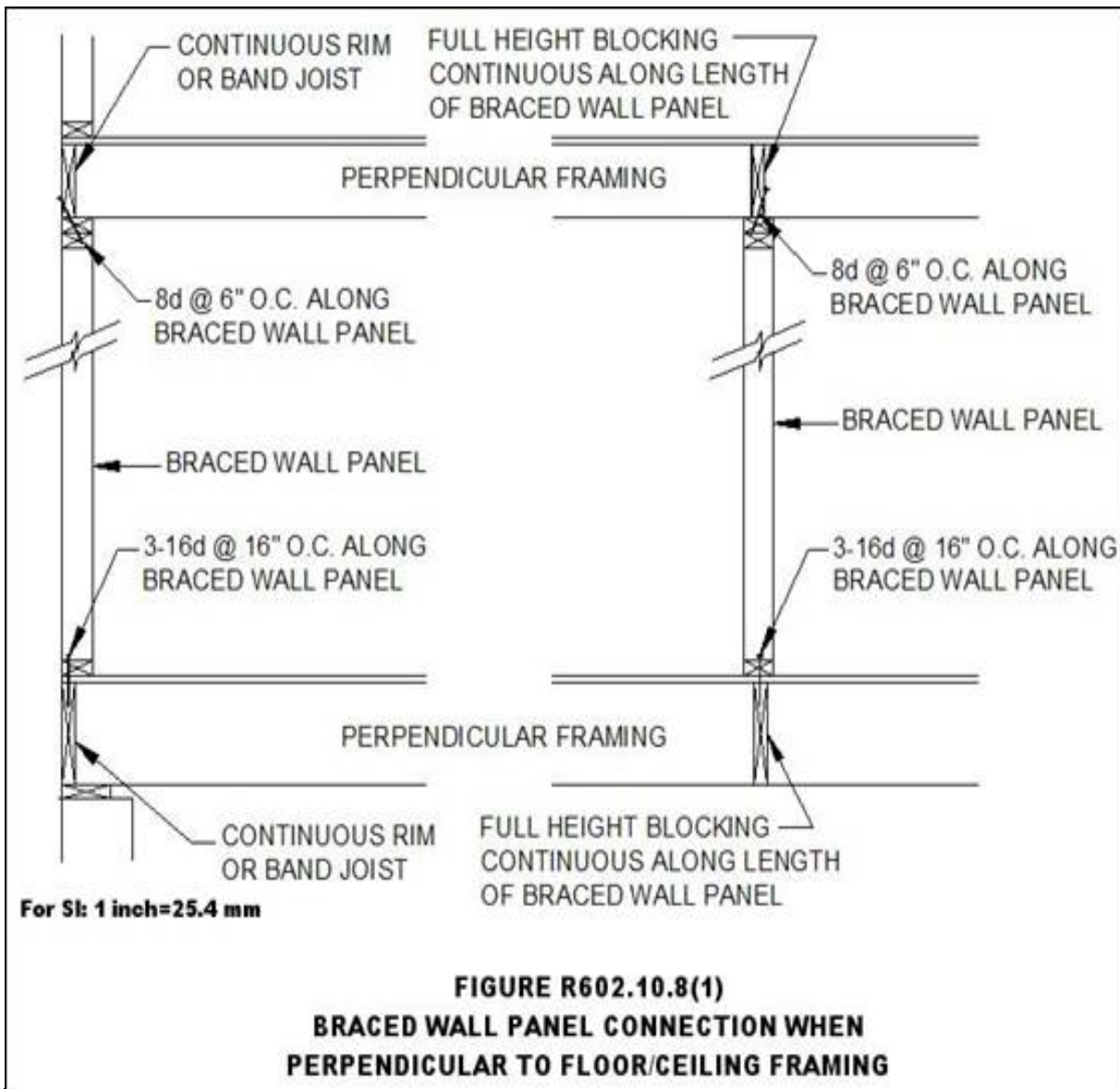

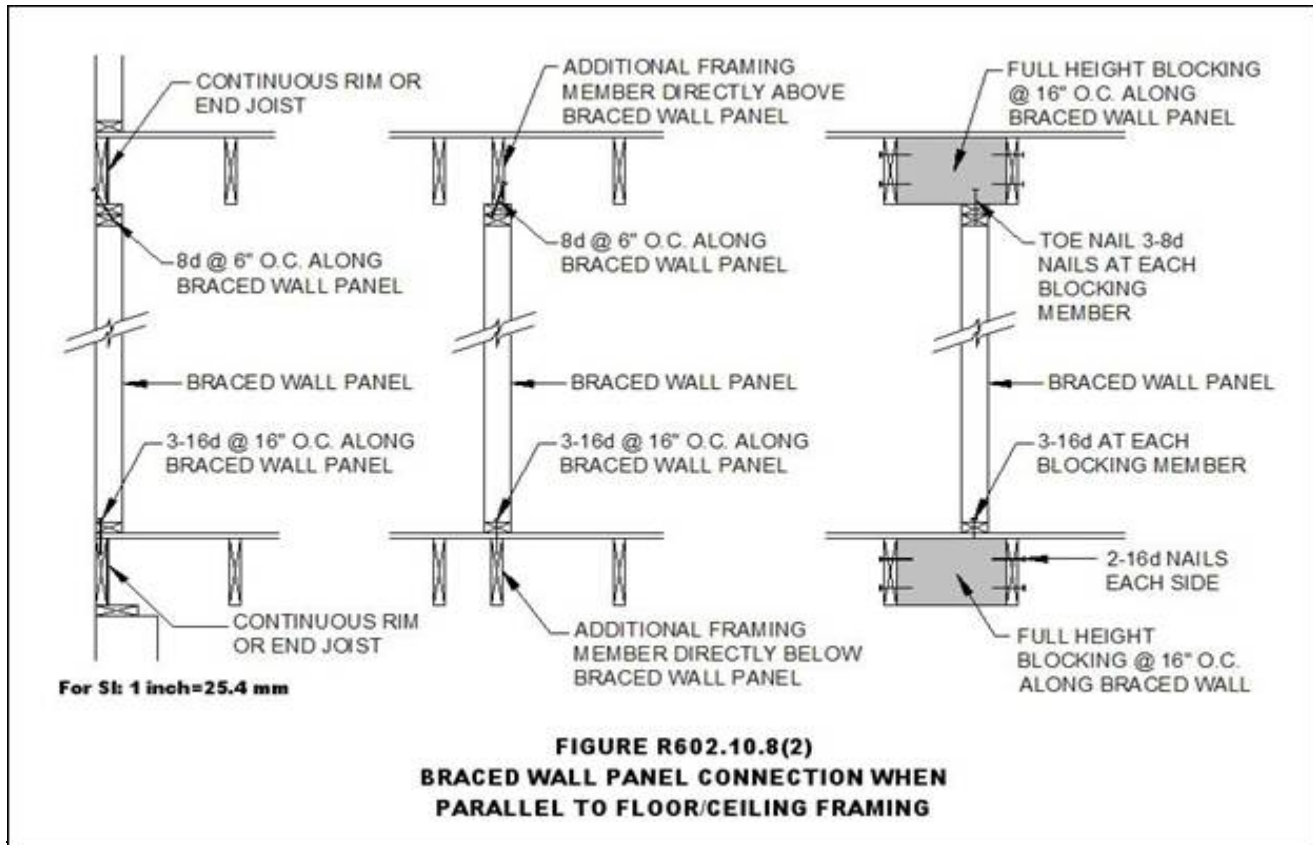

R602.10.8.1 Connections to roof framing. Top plates of exterior braced wall panels shall be attached to rafters or roof trusses above in accordance with Table R602.3(1) and this section. Where required by this section, blocking between rafters or roof trusses shall be attached to top plates of braced wall panels and to rafters and roof trusses in accordance with Table R602.3(1). A continuous band, rim, or header joist or roof truss parallel to the braced wall panels shall be permitted to replace the blocking required by this section. Blocking shall not be required over openings in continuously sheathed braced wall lines. In addition to the requirements of this section, lateral support shall be provided for rafters and ceiling joists in accordance with Section R802.8 and for trusses in accordance with Section R802.10.3. Roof ventilation shall be provided in accordance with R806.1.

1. For wind speeds less than 100 mph (45 m/s):

1.1. Where the distance from the top of the braced wall panel to the top of the rafters or roof trusses above is 9.25 inches (235 mm) or less, blocking between rafters or roof trusses shall not be required.

1.2. Where the distance from the top of the braced wall panel to the top of the rafters or roof trusses above is between 9.25 inches (235 mm) and 15.25 inches (387 mm) blocking between rafters or roof trusses shall be provided above the braced wall panel in accordance with Figure R602.10.8.1(1).

2. For wind speeds of 100 mph (45 m/s) or greater, where the distance from the top of the braced wall panel to the top of the rafters or roof trusses is 15.25 inches (387 mm) or less, blocking between rafters or roof trusses shall be provided above the braced wall panel in accordance with Figure R602.10.8.1(1).

3. Where the distance from the top of the braced wall panel to the top of the rafters or roof trusses exceeds 15.25 inches (387 mm), the top plate of the braced wall panel shall be connected to perpendicular rafters or roof trusses above in accordance with one or more of the following methods:

3.1. Soffit blocking panels constructed per Figure R602.10.8.1(2).

3.2. Vertical blocking panels constructed per Figure R602.10.8.1(3).

3.3. Full height engineered blocking panels designed per the AF&PA WFCM.

3.4. Blocking, blocking panels, or other methods of lateral load transfer designed in accordance with accepted engineering practice.

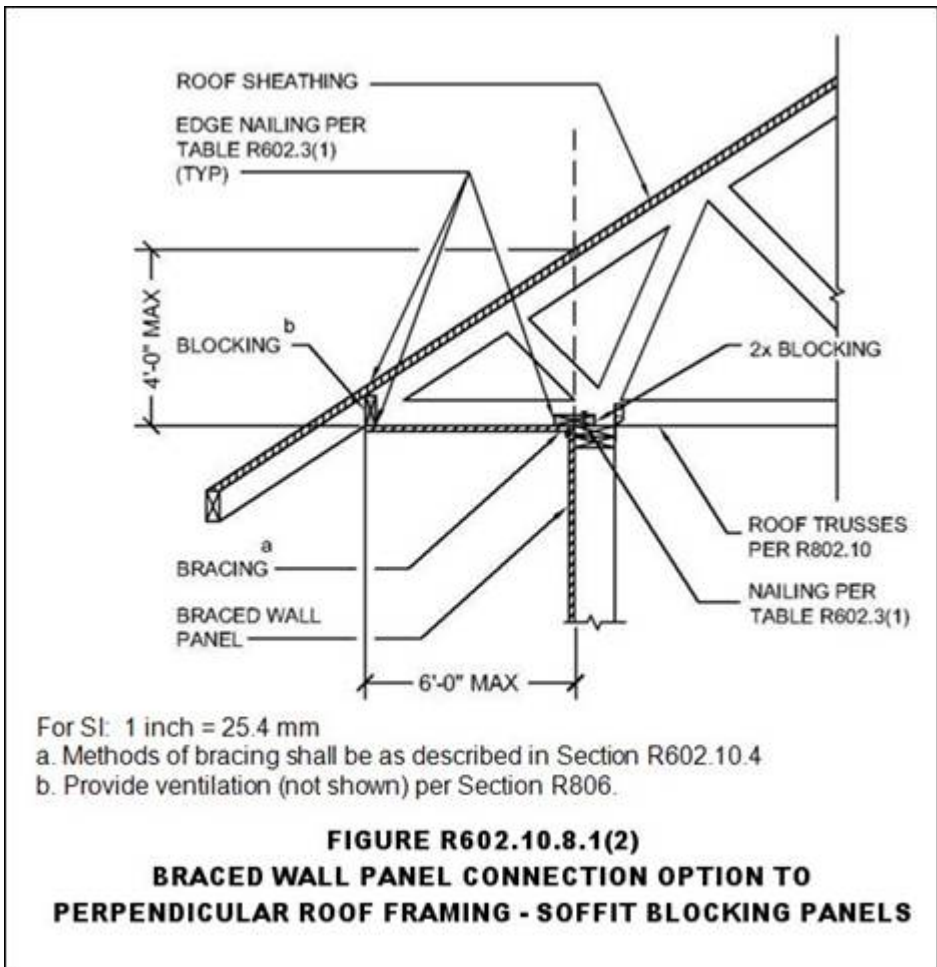
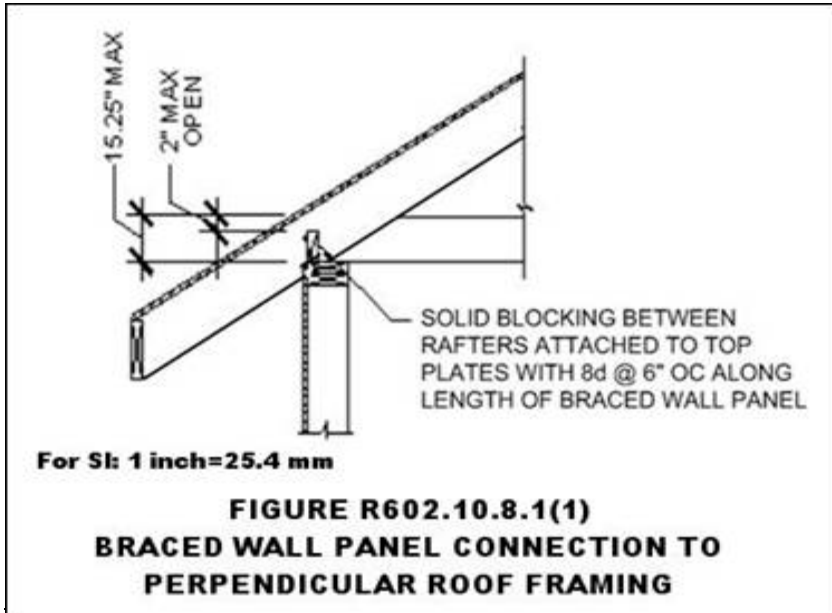

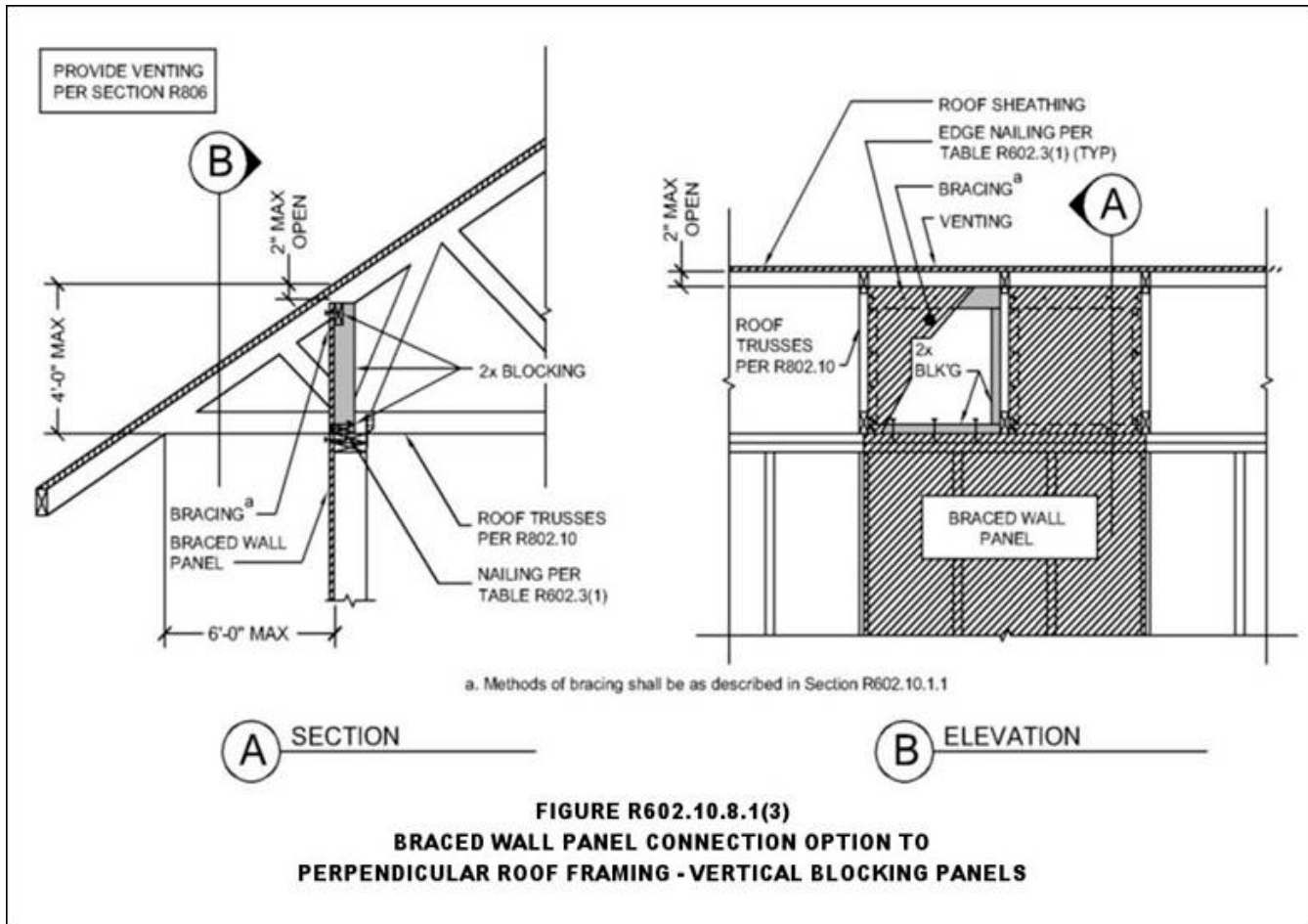

R602.10.9 Braced wall panel support. Braced wall panel support shall be provided as follows:

1. Cantilevered floor joists complying with Section R502.3.3 shall be permitted to support braced wall panels.
2. Elevated post or pier foundations supporting braced wall panels shall be designed in accordance with accepted engineering practice.
3. Masonry stem walls less than 48 inches (1220 mm) in length that support braced wall panels shall be reinforced in accordance with Figure R602.10.9. Masonry stem walls with a length greater than or equal to 48 inches (1220 mm) supporting braced wall panels shall be constructed in accordance with Section R403.1. Methods ABW and PFH shall not be permitted to attach to masonry stem walls.

4. Concrete stem walls less than 48 inches (1220 mm) in length, greater than 12 inches (305 mm) tall and less than six inches (152 mm) thick shall have reinforcement sized and located in accordance with Figure R602.10.9.

Exception: As an alternative to the Optional Stem Wall Reinforcement in Fig. R602.10.9, an approved post installed adhesive anchoring system shall be permitted. A minimum of two anchors shall be installed as indicated in Figure R602.10.9. Anchors shall be located not more than four inches (102 mm) from each end of the stem wall. Anchors shall be installed into the concrete footing as follows:

1. 5/8 inch (16 mm) threaded rod—3/4 inch (19 mm) diameter hole with a minimum embedment of six inches (152 mm).
2. No. 4 reinforcing bar—5/8 inch (16 mm) diameter hole with a minimum embedment of 4 1/2 inches (114 mm).

A minimum footing thickness of eight inches (203 mm) is required and the minimum distance from each anchor to the edge of the footing shall be 3 3/4 (95 mm).

The anchoring adhesive and anchors shall be installed in accordance with the manufactures instructions and have a minimum tensile capacity of 5,000 lbs (22 kN).

The reinforcement of the masonry stem wall and attachment of the braced wall panel to the stem wall shall be as shown in Figure R602.10.9.

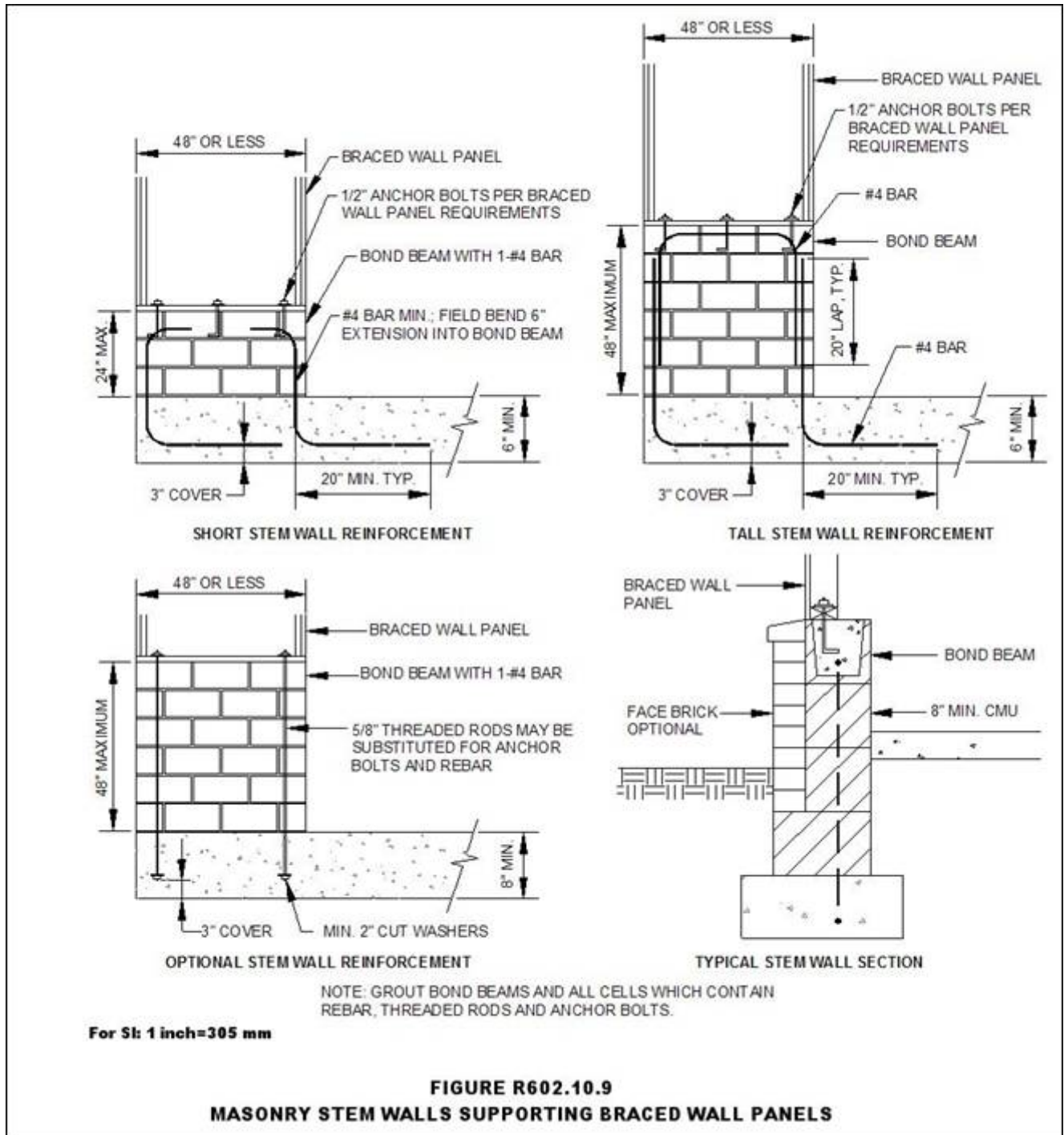

R602.10.10 Panel joints. All vertical joints of panel sheathing shall occur over and be fastened to common studs. Horizontal joints in braced wall panels shall occur over and be fastened to common blocking of a minimum 1-1/2 inch (38 mm) thickness.

Exceptions:

1. Vertical joints of panel sheathing shall be permitted to occur over double studs where adjoining panel edges are attached to separate studs with the required panel edge fastening schedule and the adjacent studs are attached together with two rows of 10d box nails (3 inches long x 0.128 inch diameter) at 10 inches (254 mm) o.c.
2. Blocking at horizontal joints shall not be required in wall segments that are not counted as braced wall panels.

Regulations

3. Where the length of bracing provided is at least twice the required length of bracing from Tables R602.10.3(1) and R602.10.3(3) blocking at horizontal joints shall not be required in braced wall panels constructed using Methods WSP, SFB, GB, PBS or HPS.

4. When Method GB panels are installed horizontally, blocking of horizontal joints is not required.

~~R602.10.11 Cripple wall bracing. Cripple walls shall be constructed in accordance with Section R602.9 and braced in accordance with this section. Cripple walls shall be braced with the length and method of bracing used for the wall above in accordance with Tables R602.10.3(1) and R602.10.3(3), except that the length of cripple wall bracing shall be multiplied by a factor of 1.15.~~

~~R602.10.11.1 Cripple wall bracing for townhouses in Seismic Design Category C. In addition to the requirements in Section R602.10.11, the distance between adjacent edges of braced wall panels shall be 14 feet (4267 mm) maximum.~~

~~Where braced wall lines at interior walls are not supported on a continuous foundation below, the adjacent parallel cripple walls, where provided, shall be braced with Method WSP or CS WSP per Section R602.10.4. The length of bracing required per Table R602.10.3(3) for the cripple walls shall be multiplied by 1.5. Where the cripple walls do not have sufficient length to provide the required bracing, the spacing of panel edge fasteners shall be reduced to four inches (102 mm) on center and the required bracing length adjusted by 0.7. If the required length can still not be provided, the cripple wall shall be designed in accordance with accepted engineering practice.~~

~~R602.10.11.2 Redesignation of cripple walls. Where all cripple wall segments along a braced wall line do not exceed 48 inches (1220 mm) in height, the cripple wall shall be permitted to be redesignated as a first story wall for purposes of determining wall bracing requirements. Where any cripple wall segment in a braced wall line exceeds 48 inches (1220 mm) in height, the entire cripple wall shall be counted as an additional story. If the cripple walls are redesignated, the stories above the redesignated story shall be counted as the second and third stories respectively.~~

50. Change Section R602.11.1 to read:

~~602.11.1 Wall anchorage for townhouses in Seismic Design Category C. Plate washers, a minimum of 0.229 inch by 3 inches by 3 inches (5.8 mm by 76 mm by 76 mm) in size, shall be provided between the foundation sill plate and the nut except where approved anchor straps are used. The hole in the plate washer is permitted to be diagonally slotted with a width of up to 3/16 inch (5 mm) larger than the bolt diameter and a slot length not to exceed 1 3/4 inches (44 mm), provided a standard cut washer is placed between the plate washer and the nut.~~

51. Delete Section R602.11.2.

52. ~~43.~~ Replace Section R602.12, including all subsections, with the following:

~~R602.12 Simplified wall bracing. Buildings meeting all of the conditions listed below shall be permitted to be braced in accordance with this section as an alternate to the requirements of Section R602.10. The entire building shall be braced in accordance with this section; the use of other bracing provisions of R602.10, except as specified herein, shall not be permitted.~~

~~1. There shall be no more than two stories above the top of a concrete or masonry foundation or basement wall. Permanent wood foundations shall not be permitted.~~

~~2. Floors shall not cantilever more than 24 inches (607 mm) beyond the foundation or bearing wall below.~~

~~3. Wall height shall not be greater than 10 feet (2743 mm).~~

~~4. The building shall have a roof eave to ridge height of 15 feet (4572 mm) or less.~~

~~5. All exterior walls shall have gypsum board with a minimum thickness of 1/2 inch (12.7 mm) installed on the interior side fastened in accordance with Table R702.3.5.~~

~~6. The structure shall be located where the basic wind speed is less than or equal to 90 mph (40 m/s) and the Exposure Category is A or B.~~

~~7. The structure shall be located in Seismic Design Category of A, B or C for detached one family and two family dwellings or Seismic Design Category A or B for townhouses.~~

~~8. Cripple walls shall not be permitted in two-story buildings.~~

~~R602.12.1 Circumscribed rectangle. Required bracing shall be determined by circumscribing a rectangle around the entire building on each floor as shown in Figure R602.12.1. The rectangle shall surround all enclosed offsets and projections such as sunrooms and attached garages. Open structures such as carports and decks shall be permitted to be excluded. The rectangle shall have no side greater than 60 feet (18 288 mm), and the ratio between the long side and short side shall be a maximum of 3:1.~~

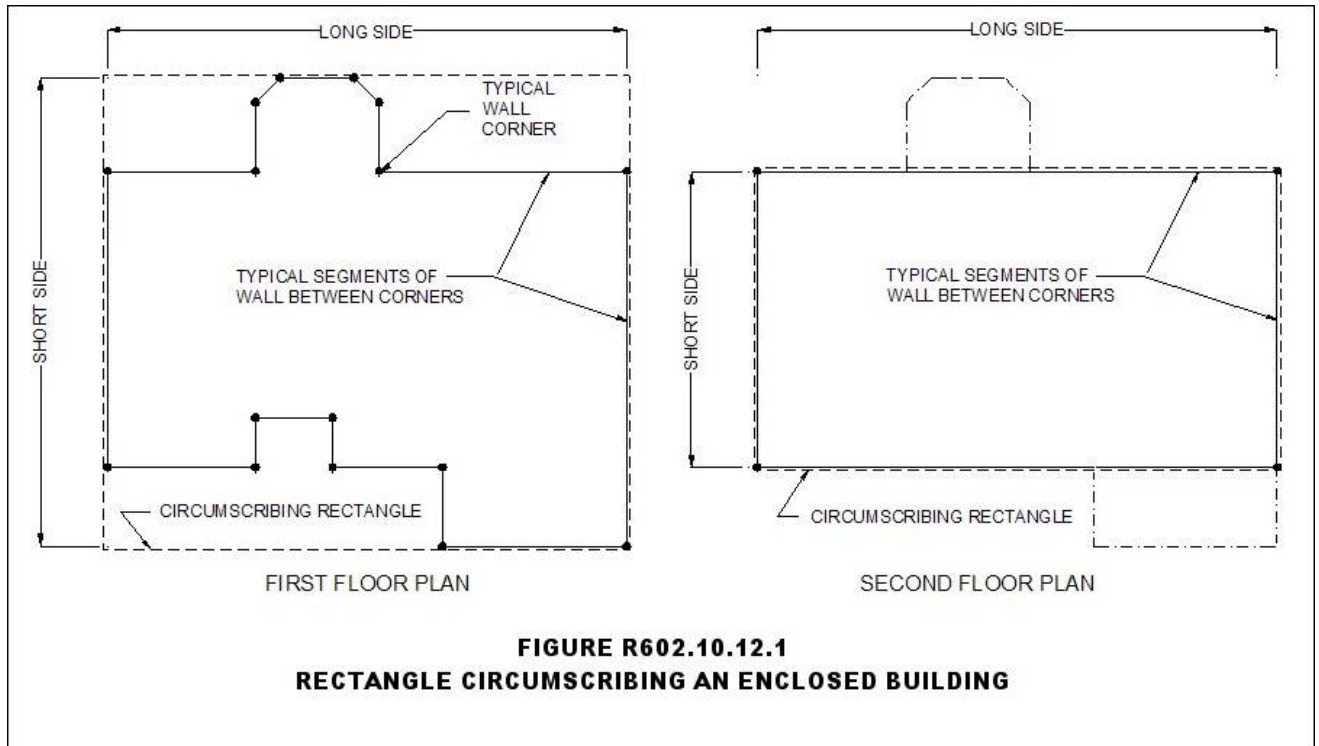

**FIGURE R602.10.12.1
RECTANGLE CIRCUMSCRIBING AN ENCLOSED BUILDING**

R602.12.2 Sheathing materials. The following sheathing materials installed on the exterior side of exterior walls shall be used to construct a bracing unit as defined in Section R602.12.3. Mixing materials is prohibited.

1. Wood structural panels with a minimum thickness of 3/8 inch (9.5 mm) fastened in accordance with Table R602.3(3).
2. Structural fiberboard sheathing with a minimum thickness of 1/2 inch (12.7 mm) fastened in accordance with Table R602.3(1).

R602.12.3 Bracing unit. A bracing unit shall be a full height sheathed segment of the exterior wall with no openings or vertical or horizontal offsets and a minimum length as specified below. Interior walls shall not contribute toward the amount of required bracing. Mixing of Items 1 and 2 below is prohibited on the same story.

1. Where all framed portions of all exterior walls are sheathed in accordance with Section R602.12.2, including wall areas between bracing units, above and below openings and on gable end walls, the minimum length of a bracing unit shall be three feet (914 mm).
2. Where the exterior walls are braced with sheathing panels in accordance with Section R602.12.2 and areas between bracing units are covered with other materials, the minimum length of a bracing unit shall be four feet (1219 mm).

R602.12.3.1 Multiple bracing units. Segments of wall compliant with Section R602.12.3 and longer than the minimum bracing unit length shall be considered as multiple bracing units. The number of bracing units shall be determined by dividing the wall segment length by the minimum bracing unit length. Full height sheathed segments of wall narrower than the minimum bracing unit length shall not contribute toward a bracing unit except as specified in Section R602.12.6.

R602.12.4 Number of bracing units. Each side of the circumscribed rectangle, as shown in Figure R602.12.1, shall have, at a minimum, the number of bracing units per Table R602.12.4 placed on the parallel exterior walls facing the side of the rectangle. Bracing units shall then be placed using the distribution requirements specified in Section R602.12.5.

Table R602.12.4 Minimum Number of Bracing Units on Each Side of the Circumscribed Rectangle														
Story Level	Eave to ridge height (feet)	Minimum number of bracing units on each long side ^{a,b}						Minimum number of bracing units on each short side ^{a,b}						
		Length of short side (ft) ^c						Length of long side (ft) ^c						
		10	20	30	40	50	60	10	20	30	40	50	60	

Regulations

	10	1	2	2	2	3	3	4	2	2	2	3	3
		2	3	3	4	5	6	2	3	3	4	5	6
	15	1	2	3	3	4	4	4	2	3	3	4	4
		2	3	4	5	6	7	2	3	4	5	6	7

For SI: 1 ft=304.8 mm

^aInterpolation shall not be permitted.

^bCripple walls or wood framed basement walls in a walk-out condition of a one-story structure shall be designed as the first floor of a two-story house.

^cActual lengths of the sides of the circumscribed rectangle shall be rounded to the next highest unit of 10 when using this table.

R602.12.5 Distribution of bracing units. The placement of bracing units on exterior walls shall meet all of the following requirements as shown in Figure R602.12.5.

1. A bracing unit shall begin no more than 12 feet (3658 mm) from any wall corner.
2. The distance between adjacent edges of bracing units shall be no greater than 20 feet (6096 mm).
3. Segments of wall greater than eight feet (2438 mm) in length shall have a minimum of one bracing unit.

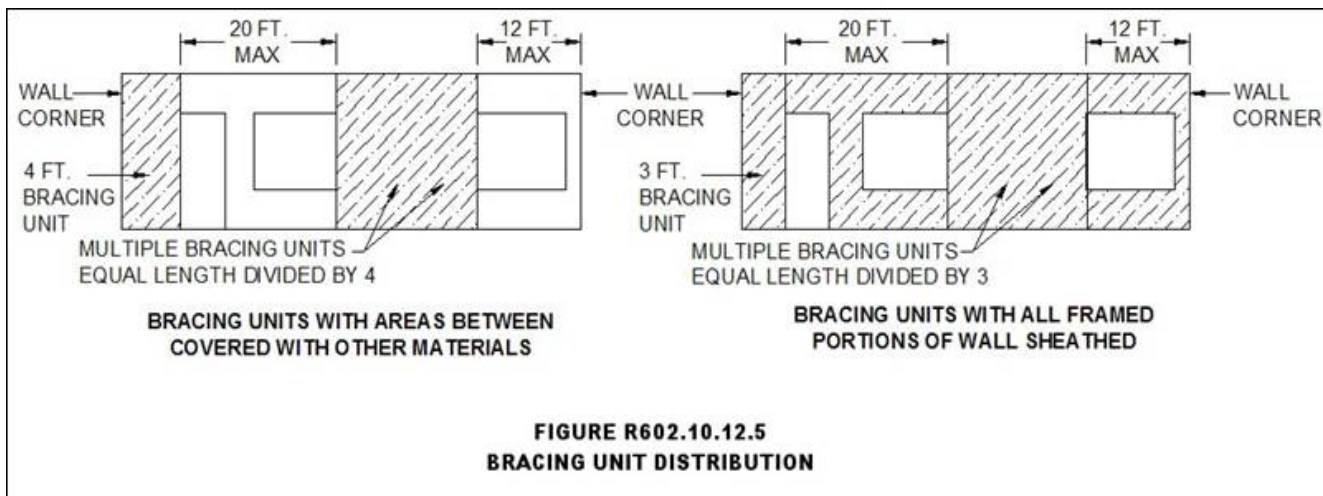

R602.12.6 Narrow panels. The bracing methods referenced in Section R602.10 and specified in Sections R602.12.6.1 through R602.12.6.3 shall be permitted when using simplified wall bracing.

R602.12.6.1 Method CS-G. Braced wall panels constructed as Method CS-G in accordance with Tables R602.10.4.1 and R602.10.5 shall be permitted for one-story garages when all framed portions of all exterior walls are sheathed with wood structural panels. Each CS-G panel shall be equivalent to 0.5 bracing units.

R602.12.6.2 Method CS-PF. Braced wall panels constructed as Method CS-PF in accordance with Section R602.10.6.4 shall be permitted when all framed portions of all exterior walls are sheathed with wood structural panels. Each CS-PF panel shall equal 0.5 bracing units. A maximum of four CS-PF panels shall be permitted on all the segments of walls parallel to each side of the circumscribed rectangle.

~~R602.12.6.3 Methods PFH and PFG. Braced wall panels constructed as Method PFH, in accordance with Section R602.10.6.2, and PFG, in accordance with Section R602.10.6.3, shall be permitted when bracing units are constructed using wood structural panels. Each PFH panel shall equal one bracing unit, and each PFG shall equal 0.75 bracing units.~~

~~R602.12.7 Lateral support. For bracing units located along the eaves, the vertical distance from the outside edge of the top wall plate to the roof sheathing above shall not exceed 9.25 inches (235 mm) at the location of a bracing unit unless lateral support is provided in accordance with Section R602.10.8.1.~~

~~R602.12.8 Stem walls. Masonry stem walls with a height and length of 48 inches (1219 mm) or less supporting a bracing unit or a Method CS-G, CS-PF or PFG braced wall panel shall be constructed in accordance with Figure R602.10.9. Concrete stem walls greater than 12 inches (305 mm) tall and less than six inches (152 mm) thick shall have reinforcement sized and located in accordance with Figure R602.10.9.~~

R602.12 Practical wall bracing. All buildings in Seismic Design Categories A and B and detached buildings in Seismic Design Category C shall be permitted to be braced in accordance with this section as an alternative to the requirements of Section R602.10. Where a building, or portion thereof, does not comply with one or more of the bracing requirements in this section, those portions shall be designed and constructed in accordance with Section R301.1. The use of other bracing provisions of Section R602.10, except as specified herein, shall not be permitted.

The building official shall be permitted to require the permit applicant to identify bracing on the construction documents and provide associated analysis. The building official shall be permitted to waive the analysis of the upper floors where the cumulative length of wall openings of each upper floor wall is less than or equal to the length of the openings of the wall directly below.

R602.12.1 Sheathing materials. The following materials shall be permitted for use as sheathing for wall bracing. Exterior walls shall be sheathed on all sheathable surfaces, including infill areas between bracing locations, above and below wall openings, and on gable end walls.

1. Wood structural panels with a minimum thickness of 7/16 inch (9.5 mm) fastened in accordance with Table R602.3(3).
2. Structural fiberboard sheathing with a minimum thickness of 1/2 inch (12.7 mm) fastened in accordance with Table R602.3(1).
3. Gypsum board with a minimum thickness of 1/2 inch (12.7 mm) fastened in accordance with Table R702.3.5 on interior walls only.

R602.12.2 Braced wall panels. Braced wall panels shall be full-height wall sections sheathed with the materials listed in Section R602.12.1 and complying with the following:

1. Exterior braced wall panels shall have a minimum length based on the height of the adjacent opening as specified in Table R602.12.2. Panels with openings on both sides of differing heights shall be governed by the taller opening when determining panel length.
2. Interior braced wall panels shall have a minimum length of 48 inches (1220 mm) when sheathing material is applied to one side. Doubled-sided applications shall be permitted to be considered two braced wall panels.
3. Braced wall panels shall be permitted to be constructed of Methods ABW, PFH, PFG, and CS-PF in accordance with Section R602.10.4.
4. Exterior braced wall panels, other than the methods listed in Item 3 above shall have a finish material installed on the interior. The finish material shall consist of 1/2 inch (12.7 mm) gypsum board or equivalent and shall be permitted to be omitted where the required length of bracing, as determined in Section R602.12.4, is multiplied by 1.40, unless otherwise required by Section R302.6.
5. Vertical sheathing joints shall occur over and be fastened to common studs.
6. Horizontal sheathing joints shall be edge nailed to 1-1/2 inch (38 mm) minimum thick common blocking.

<u>Table R602.12.2</u>					
<u>Braced Wall Panel Lengths^a</u>					
<u>Adjacent opening or clear opening height (inches)</u>	<u>Minimum Panel Length (inches)</u>				
	<u>Wall Height (feet)</u>				
	<u>8</u>	<u>9</u>	<u>10</u>	<u>11</u>	<u>12</u>
<u>Garage door opening^b</u>	<u>24</u>	<u>27</u>	<u>30</u>	<u>33</u>	<u>36</u>

Regulations

≤ 64	<u>24</u>	<u>27</u>	<u>30</u>	<u>33</u>	<u>36</u>
≤ 72	<u>27</u>	<u>27</u>	<u>30</u>	<u>33</u>	<u>36</u>
≤ 80	<u>30</u>	<u>30</u>	<u>30</u>	<u>33</u>	<u>36</u>
> 80	<u>36</u>	<u>36</u>	<u>36</u>	<u>40</u>	<u>40</u>

For SI: 1 inch = 25.4 mm, 1 foot = 304.8 mm.

a. Interpolation shall be permitted for openings greater than 64 inches (1626 mm) and less than 80 inches (2032 mm); extrapolation shall be prohibited.

b. Braced wall panels of a one-story garage located on each side of the garage door opening and supporting a gable end wall or roof load only.

R602.12.3 Circumscribed rectangle. Required length of bracing shall be determined by circumscribing one or more rectangles around the entire building or portions thereof as shown in Figure R602.12.3. Rectangles shall surround all enclosed offsets and projections such as sunrooms and attached garages. Chimneys, partial height projections, and open structures, such as carports and decks, shall be excluded from the rectangle. Each rectangle shall have no side greater than 80 feet (24 384 mm) with a maximum 3:1 ratio between the long and short side. Rectangles shall be permitted to be skewed to accommodate angled projections as shown in Figure R602.12.4.3.

Editor's Note - Figures R602.12.3, R602.12.4.1, R602.12.4.1, R602.12.4.3, and R602.12.6 in this section shown below this note are new text.

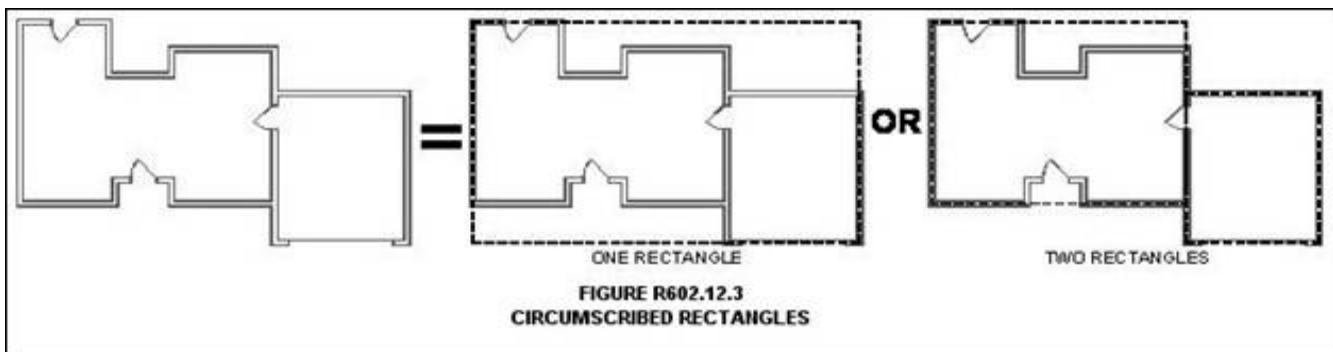

R602.12.3.1 Townhouses. Rectangles shall be circumscribed around individual townhouses.

R602.12.4 Required length of bracing. The required length of bracing for each side of a circumscribed rectangle shall be determined using Table R602.12.4. Where multiple rectangles share a common side or sides, the required length of bracing shall equal the sum of the required lengths from all shared rectangle sides.

Wind Speed	Eave-to-Ridge Height (feet)	Number of Floor Levels Above ^{e,f}	Required Length of Bracing on Front/Rear Side (feet)								Required Length of Bracing on Left/Right Side (feet)							
			Length of Left/Right Side (feet)								Length of Front/Rear Side (feet)							
			10	20	30	40	50	60	70	80	10	20	30	40	50	60	70	80
90	10	0	2.0	3.5	5.0	6.0	7.5	9.0	10.5	12.0	2.0	3.5	5.0	6.0	7.5	9.0	10.5	12.0
		1	3.5	6.5	9.0	12.0	14.5	17.0	19.8	22.6	3.5	6.5	9.0	12.0	14.5	17.0	19.8	22.6
	2	5.0	9.5	13.5	17.5	21.5	25.0	29.2	33.4	5.0	9.5	13.5	17.5	21.5	25.0	29.2	33.4	
	15	0	2.6	4.6	6.5	7.8	9.8	11.7	13.7	15.7	2.6	4.6	6.5	7.8	9.8	11.7	13.7	15.7
1		4.0	7.5	10.4	13.8	16.7	19.6	22.9	26.2	4.0	7.5	10.4	13.8	16.7	19.6	22.9	26.2	

		<u>2</u>	<u>5.5</u>	<u>10.5</u>	<u>14.9</u>	<u>19.3</u>	<u>23.7</u>	<u>27.5</u>	<u>32.1</u>	<u>36.7</u>	<u>5.5</u>	<u>10.5</u>	<u>14.9</u>	<u>19.3</u>	<u>23.7</u>	<u>27.5</u>	<u>32.1</u>	<u>36.7</u>
	<u>20</u>	<u>0</u>	<u>2.9</u>	<u>5.2</u>	<u>7.3</u>	<u>8.8</u>	<u>11.1</u>	<u>13.2</u>	<u>15.4</u>	<u>17.6</u>	<u>2.9</u>	<u>5.2</u>	<u>7.3</u>	<u>8.8</u>	<u>11.1</u>	<u>13.2</u>	<u>15.4</u>	<u>17.6</u>
		<u>1</u>	<u>4.5</u>	<u>8.5</u>	<u>11.8</u>	<u>15.6</u>	<u>18.9</u>	<u>22.1</u>	<u>25.8</u>	<u>29.5</u>	<u>4.5</u>	<u>8.5</u>	<u>11.8</u>	<u>15.6</u>	<u>18.9</u>	<u>22.1</u>	<u>25.8</u>	<u>29.5</u>
		<u>2</u>	<u>6.2</u>	<u>11.9</u>	<u>16.8</u>	<u>21.8</u>	<u>27.3</u>	<u>31.1</u>	<u>36.3</u>	<u>41.5</u>	<u>6.2</u>	<u>11.9</u>	<u>16.8</u>	<u>21.8</u>	<u>27.3</u>	<u>31.1</u>	<u>36.3</u>	<u>41.5</u>
<u>100</u>	<u>10</u>	<u>0</u>	<u>2.5</u>	<u>4.0</u>	<u>6.0</u>	<u>7.5</u>	<u>9.5</u>	<u>11.0</u>	<u>12.8</u>	<u>14.6</u>	<u>2.5</u>	<u>4.0</u>	<u>6.0</u>	<u>7.5</u>	<u>9.5</u>	<u>11.0</u>	<u>12.8</u>	<u>14.6</u>
		<u>1</u>	<u>4.5</u>	<u>8.0</u>	<u>11.0</u>	<u>14.5</u>	<u>18.0</u>	<u>21.0</u>	<u>24.5</u>	<u>28.0</u>	<u>4.5</u>	<u>8.0</u>	<u>11.0</u>	<u>14.5</u>	<u>18.0</u>	<u>21.0</u>	<u>24.5</u>	<u>28.0</u>
		<u>2</u>	<u>6.0</u>	<u>11.5</u>	<u>16.5</u>	<u>21.5</u>	<u>26.5</u>	<u>31.0</u>	<u>36.2</u>	<u>41.4</u>	<u>6.0</u>	<u>11.5</u>	<u>16.5</u>	<u>21.5</u>	<u>26.5</u>	<u>31.0</u>	<u>36.2</u>	<u>41.4</u>
	<u>15</u>	<u>0</u>	<u>3.4</u>	<u>5.2</u>	<u>7.8</u>	<u>9.8</u>	<u>12.4</u>	<u>14.3</u>	<u>16.7</u>	<u>19.1</u>	<u>3.4</u>	<u>5.2</u>	<u>7.8</u>	<u>9.8</u>	<u>12.4</u>	<u>14.3</u>	<u>16.7</u>	<u>19.1</u>
		<u>1</u>	<u>5.2</u>	<u>9.2</u>	<u>12.7</u>	<u>16.7</u>	<u>20.7</u>	<u>24.2</u>	<u>28.2</u>	<u>32.2</u>	<u>5.2</u>	<u>9.2</u>	<u>12.7</u>	<u>16.7</u>	<u>20.7</u>	<u>24.2</u>	<u>28.2</u>	<u>32.2</u>
		<u>2</u>	<u>6.6</u>	<u>12.7</u>	<u>18.2</u>	<u>23.7</u>	<u>29.2</u>	<u>34.1</u>	<u>39.8</u>	<u>45.5</u>	<u>6.6</u>	<u>12.7</u>	<u>18.2</u>	<u>23.7</u>	<u>29.2</u>	<u>34.1</u>	<u>39.8</u>	<u>45.5</u>
	<u>20</u>	<u>0</u>	<u>3.8</u>	<u>5.9</u>	<u>8.8</u>	<u>11.1</u>	<u>14.0</u>	<u>16.2</u>	<u>18.9</u>	<u>21.6</u>	<u>3.8</u>	<u>5.9</u>	<u>8.8</u>	<u>11.1</u>	<u>14.0</u>	<u>16.2</u>	<u>18.9</u>	<u>21.6</u>
		<u>1</u>	<u>5.9</u>	<u>10.4</u>	<u>14.4</u>	<u>18.9</u>	<u>23.4</u>	<u>27.3</u>	<u>31.8</u>	<u>36.3</u>	<u>5.9</u>	<u>10.4</u>	<u>14.4</u>	<u>18.9</u>	<u>23.4</u>	<u>27.3</u>	<u>31.8</u>	<u>36.3</u>
		<u>2</u>	<u>7.5</u>	<u>14.4</u>	<u>20.6</u>	<u>26.8</u>	<u>33.0</u>	<u>38.5</u>	<u>44.9</u>	<u>51.3</u>	<u>7.5</u>	<u>14.4</u>	<u>20.6</u>	<u>26.8</u>	<u>33.0</u>	<u>38.5</u>	<u>44.9</u>	<u>51.3</u>

For SI: 1 ft = 304.8 mm.

a. Interpolation shall be permitted; extrapolation shall be prohibited.

b. For Exposure Category C, multiply the required length of bracing by a factor of 1.20 for a one-story building, 1.30 for a two-story building, and 1.40 for a three-story building.

c. For wall height adjustments multiply the required length of bracing by the following factors: 0.90 for 8 feet (2438 mm), 0.95 for 9 feet (2743 mm), 1.0 for 10 feet (3048 mm), 1.05 for 11 feet (3353 mm), and 1.10 for 12 feet (3658 mm).

d. Where braced wall panels have been sheathed in wood structural panels with edge fasteners spaced at 4 inches (102 mm) on center, multiply the required length of bracing by 0.83.

e. A floor level, habitable or otherwise, contained wholly within the roof rafters or trusses shall not be considered a floor level for purposes of determining the required length of bracing.

f. A rectangle side with differing number of floor levels above shall use the greatest number when determining the required length of bracing.

R602.12.4.1 Braced wall panel assignment to rectangle sides. Braced wall panels shall be assigned to the applicable rectangle side and contribute to its required length of bracing. Panels shall be assigned as specified below and as shown in Figure R602.12.4.1.

1. Exterior braced wall panels shall be assigned to the parallel rectangle side on which they are located or in which they face.

2. Interior braced wall panels shall be assigned to the parallel rectangle side on which they are located or in which they face up to 4 feet (1220 mm) away. Interior braced wall panels more than 4 feet (1220 mm) away from a parallel rectangle side shall not contribute.

3. The projections of angled braced wall panels shall be assigned to the adjacent rectangle sides.

Regulations

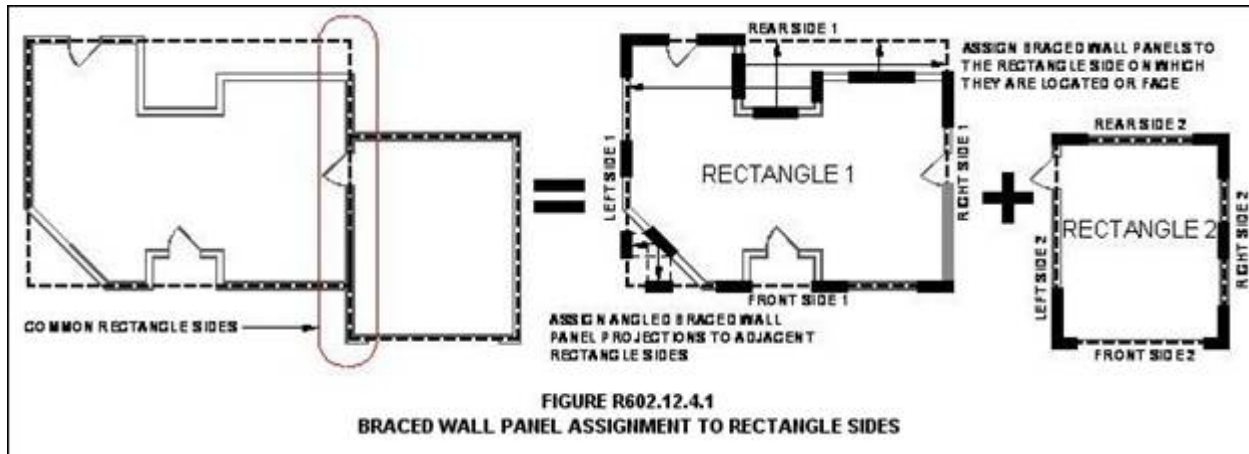

R602.12.4.2 Contributing length. The cumulative contributing length of braced wall panels assigned to a rectangle side shall be greater than or equal to the required length of bracing as determined in Section R602.12.4. The contributing length of a braced wall panel shall be as specified below. When applying contributing length to angled braced wall panels, apply the requirements below to each projection:

1. Exterior braced wall panels shall contribute their actual length.
2. Interior braced wall panels shall contribute one-half of their actual length.
3. The contributing length of Methods ABW, PFH, PFG, and CS-PF shall be in accordance with Table R602.10.5.

R602.12.4.3 Common sides with skewed rectangles. Braced wall panels located on a common wall where skewed rectangles intersect, as shown in Figure R602.12.4.3, shall be permitted to be assigned to the parallel rectangle side, and their projections shall be permitted to be assigned to the adjacent skewed rectangle sides.

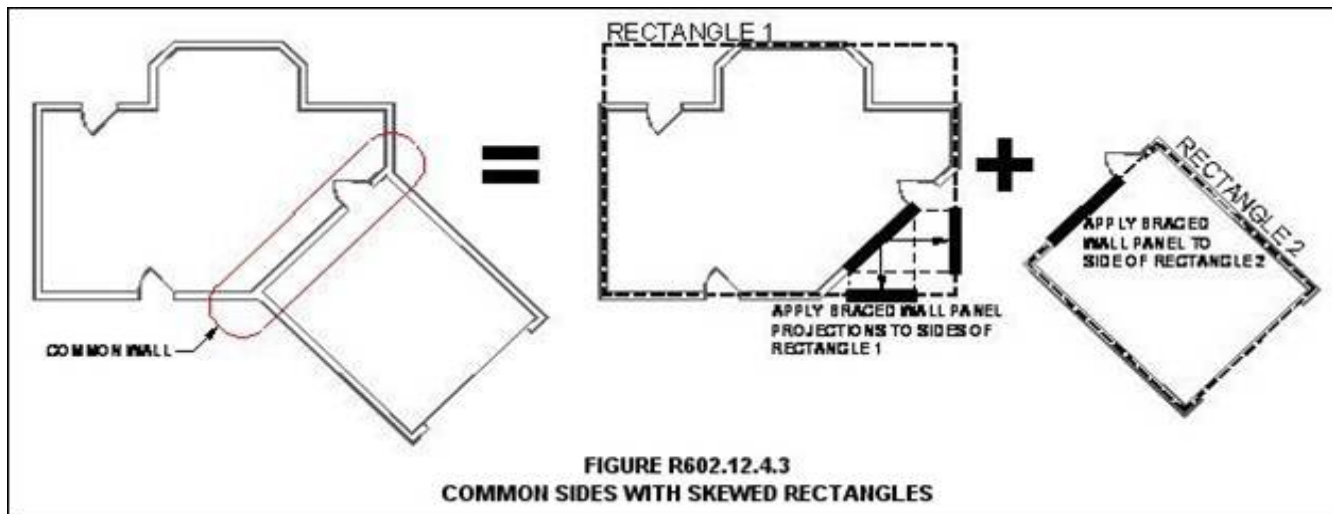

R602.12.5 Cripple walls and framed walls of walk-out basements. For rectangle sides with cripple walls having a maximum height of 48 inches (1220 mm), the required length of bracing shall be as determined in Section R602.12.4. For rectangle sides with cripple walls having a height greater than 48 inches (1220 mm) at any location or framed walls of a walk-out basement, the required length of bracing shall be determined using Table R602.12.4. Braced wall panels within cripple walls and walls of walk-out basements shall comply with Item 4 of Section R602.12.2.

R602.12.6 Distribution of braced wall panels. Braced wall panels shall be distributed in accordance with the following requirements as shown in Figure R602.12.6.

1. The edge of a braced wall panel shall be no more than 12 feet (3658 mm) from any building corner or rectangle corner.
2. The distance between adjacent edges of braced wall panels shall be no more than 20 feet (6096 mm).
3. Segments of exterior walls greater than 8 feet (2438 mm) in length shall have a minimum of one braced wall panel.
4. Segments of exterior wall 8 feet (2438 mm) or less in length shall be permitted to have no braced wall panels.

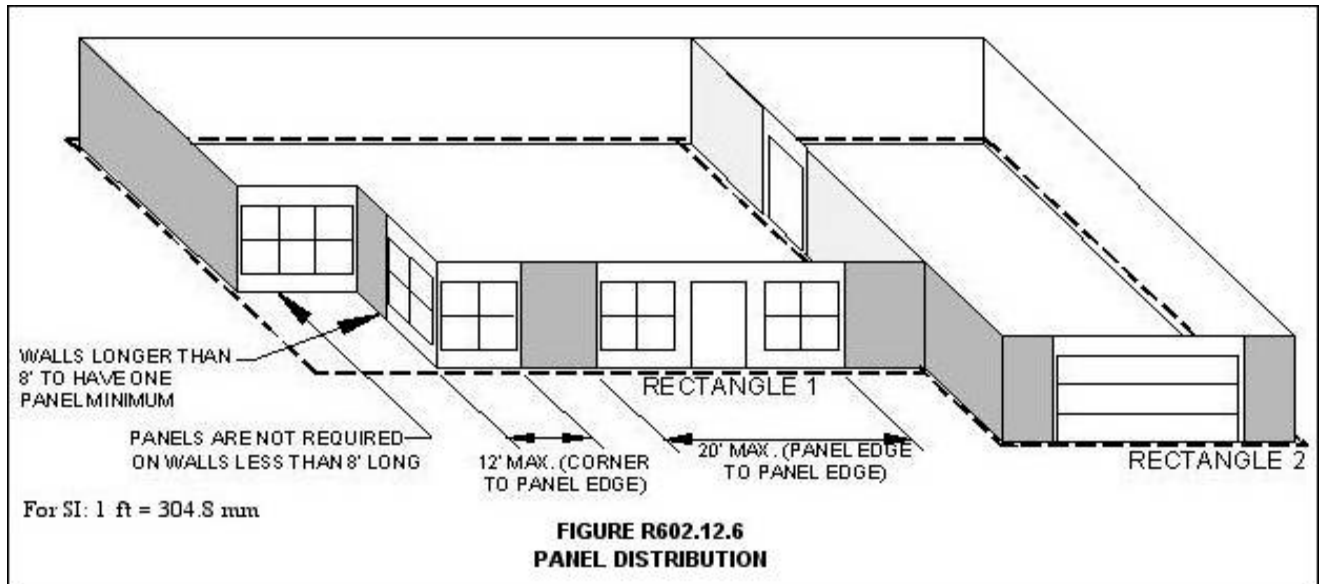

R602.12.6.1 Panels adjacent to balloon framed walls. Braced wall panels shall be placed on each side of each story adjacent to balloon framed walls designed in accordance with Section R602.3 with a maximum height of two stories.

R602.12.7 Braced wall panel connection. Braced wall panels shall be connected to other structural elements in accordance with Section R602.10.8.

R602.12.8 Braced wall panel support. Braced wall panels shall be supported in accordance with Section R602.10.9.

53. Change Section R612.2 to read:

R612.2 Window sills. In dwelling units, where the opening of an operable window is located more than 72 inches (1829 mm) above the finished grade or surface below, the lowest part of the clear opening of the window shall be a minimum of 18 inches (457 mm) above the finished floor of the room in which the window is located. Operable sections of windows shall not permit openings that allow passage of a 4 inch diameter (102 mm) sphere where such openings are located within 18 inches (457 mm) of the finished floor.

Exceptions:

1. Windows whose openings will not allow a 4 inch diameter (102 mm) sphere to pass through the opening when the opening is in its largest opened position.
2. Openings that are provided with window fall prevention devices that comply with Section R612.3.
3. Openings that are provided with fall protection devices that comply with ASTM F 2090.
4. Windows that are provided with opening limiting devices that comply with Section R612.4.

54. Change Section R703.7 to read:

R703.7 Stone and masonry veneer, general. Stone and masonry veneer shall be installed in accordance with this chapter, Table R703.4 and Figure R703.7. These veneers installed over a backing of wood or cold formed steel shall be limited to the first story above grade and shall not exceed five inches (127 mm) in thickness. See Tables R602.10.3(3) and R602.10.3(4) for wall bracing requirements for masonry veneer for wood framed construction and Section R603.9.5 for wall bracing requirements for masonry veneer for cold formed steel construction.

Exceptions:

1. For all buildings in Seismic Design Categories A, B and C, exterior stone or masonry veneer, as specified in Table R703.7(1), with a backing of wood or steel framing shall be permitted to the height specified in Table R703.7(1) above a noncombustible foundation.
2. For detached one family or two family dwellings in Seismic Design Categories D₀, D₁ and D₂, exterior stone or masonry veneer, as specified in Table R703.7(2), with a backing of wood framing shall be permitted to the height specified in Table R703.7(2) above a noncombustible foundation.

55. Delete the reference to footnote "f" and the footnote itself in Figure R802.11.

44. Change Section R807.1 to read:

R807.1 Attic access. Buildings with combustible ceiling or roof construction shall have an attic access opening to attic areas 30 square feet (2.8 m²) or larger having a vertical height of not less than 30 inches (762 mm). The vertical height shall be measured from the top of the ceiling framing members to the underside of the roof framing members.

Regulations

The rough-framed opening shall not be less than 22 inches by 30 inches (559 mm by 762 mm) and shall be located in a hallway or other readily accessible location. When located in a wall, the opening shall be a minimum of 22 inches wide by 30 inches high (559 mm wide by 762 mm high). When the access is located in a ceiling, minimum unobstructed headroom in the attic space shall be 30 inches (762 mm) at some point above the access measured vertically from the bottom of ceiling framing members. See Section M1305.1.3 for access requirements where mechanical equipment is located in attics.

45. Delete Section R905.2.8.5.

46. Change Section R1001.8 to read:

R1001.8 Smoke chamber. Smoke chamber walls shall be constructed of solid masonry units, hollow masonry units grouted solid, stone, or concrete. The total minimum thickness of front, back, and side walls shall be 8 inches (203 mm) of solid masonry. When the inside surface of the smoke chamber is formed by corbelled masonry, the inside surface shall be parged smooth. When a lining of firebrick at least 2 inches (51 mm) thick, or a lining of vitrified clay at least 5/8 inch (16 mm) thick, is provided, the total minimum thickness of front, back, and side walls shall be 6 inches (152 mm) of solid masonry, including the lining. Firebrick shall conform to ASTM C 1261 and shall be laid with medium duty refractory mortar conforming to ASTM C 199. Vitrified clay linings shall conform to ASTM C 315.

56- 47. Delete Section ~~N1101.9~~ N1101.16 (R401.16).

48. Change the ceiling R-value and wood frame wall R-value categories for climate zone "4 except Marine" in Table N1102.1.1 (R402.1.1) to read:

Ceiling R-Value	Wood Frame Wall R-Value
38	15 or 13 + 1 ^h

49. Change the ceiling U-factor and frame wall U-factor categories for climate zone "4 except Marine" in Table N1102.1.3 (R402.1.3) to read:

Ceiling U-Factor	Frame Wall U-Factor
0.030	0.079

50. Change Sections N1102.2.1 (R402.2.1) and N1102.2.4 (R402.2.4) to read:

N1102.2.1 (R402.2.1) Ceilings with attic spaces. When Section N1102.1.1 would require R-38 in the ceiling, installing R-30 over 100% of the ceiling area shall be deemed to satisfy the requirement for R-38 wherever the full height of uncompressed R-30 insulation extends over the wall top plate at the eaves. Similarly, when Section N1102.1.1 would require R-49 in the ceiling, installing

R-38 over 100% of the ceiling area shall be deemed to satisfy the requirement for R-49 wherever the full height of uncompressed R-38 insulation extends over the wall top plate at the eaves. This reduction shall not apply to the U-factor alternative approach in Section N1102.1.3 and the total UA alternative in Section N1102.1.4.

N1102.2.4 (R402.2.4) Access hatches and doors. Access doors from conditioned spaces to unconditioned spaces (e.g., attics and crawl spaces) shall be weatherstripped and insulated in accordance with the following values:

1. Hinged vertical doors shall have a minimum overall R-5 insulation value;

2. Hatches and scuttle hole covers shall be insulated to a level equivalent to the insulation on the surrounding surfaces; and

3. Pull down stairs shall have a minimum of 75% of the panel area having R-5 rigid insulation.

Access shall be provided to all equipment that prevents damaging or compressing the insulation. A wood framed or equivalent baffle or retainer is required to be provided when loose fill insulation is installed, the purpose of which is to prevent the loose fill insulation from spilling into the living space when the attic access is opened, and to provide a permanent means of maintaining the installed R-value of the loose fill insulation.

51. Delete Section N1102.3.6 (R402.3.6) and change Sections N1102.4 (R402.4) and N1102.4.1.1 (R402.4.1.1) to read:

N1102.4 (R402.4) Air leakage. The building thermal envelope shall be constructed to limit air leakage in accordance with the requirements of Sections N1102.4.1 through N1102.4.4.

N1102.4.1.1 (R402.4.1.1) Installation (Mandatory). The components of the building thermal envelope as listed in Table N1102.4.1.1 shall be installed in accordance with the manufacturer's instructions and the criteria listed in Table N1102.4.1.1, as applicable to the method of construction. Where required by the code official, an approved third party shall inspect all components and verify compliance.

52. Change the title of the "Criteria" category of Table N1102.4.1.1 (R402.4.1.1); change the "Walls," "Shower/tub on exterior wall," and "Fireplace" categories of Table N1102.4.1.1 (R402.4.1.1), and add footnotes "b" and "c" to Table N1102.4.1.1 (R402.4.1.1) to read:

Component	Criteria ^{a,b}
Walls	Cavities within corners and headers shall be insulated by completely filling the cavity with a material having a minimum thermal resistance of R-3 per inch.

	<p><u>The junction of the foundation and sill plate shall be sealed.</u></p> <p><u>The junction of the top plate and top of exterior walls shall be sealed.</u></p> <p><u>Exterior thermal envelope insulation for framed walls shall be installed in substantial contact and continuous alignment with the air barrier.</u></p> <p><u>Knee walls shall be sealed.</u></p>
Shower/tub on exterior wall ^c	<p><u>Exterior walls adjacent to showers and tubs shall be insulated, and an air barrier shall be installed on the interior side of the exterior wall, adjacent to the shower or tub.</u></p>
Fireplace	<p><u>An air barrier shall be installed on fireplace walls. Fireplaces shall have gasketed doors or tight-fitting flue dampers.</u></p>
<p><u>b. Structural integrity of headers shall be in accordance with the applicable building code.</u></p> <p><u>c. Air barriers used behind showers and tubs on exterior walls shall be of a permeable material that does not cause the entrapment of moisture in the stud cavity.</u></p>	

53. Change Section N1102.4.1.2 (R402.4.1.2) and add Sections N1102.4.1.2.1 (R402.4.1.2.1), N1102.4.1.2.2 (R402.4.1.2.2), and N1102.4.1.3 (R402.4.1.3) to read:

N1102.4.1.2 (R402.4.1.2) Air sealing. Building envelope air tightness shall be demonstrated to comply with either Section N1102.4.1.2.1 or N1102.4.1.2.2.

N1102.4.1.2.1 (R402.4.1.2.1) Testing option. The building or dwelling unit shall be tested for air leakage. Testing shall be conducted with a blower door at a pressure of 0.2 inches water gauge (w.g.) (50 Pascals (Pa)). Where required by the building official, testing shall be conducted by an approved third party. A written report of the results of the test shall be signed by the party conducting the test and provided to the building official. Testing shall be performed at any time after creation of all penetrations of the building thermal envelope.

During testing:

1. Exterior windows and doors and fireplace and stove doors shall be closed, but not sealed beyond the intended weatherstripping or other infiltration control measures;

2. Dampers, including exhaust, intake, makeup air, backdraft, and flue dampers shall be closed, but not sealed beyond intended infiltration control measures;

3. Interior doors, if installed at the time of the test, shall be open;

4. Exterior doors for continuous ventilation systems and heat recovery ventilators shall be closed and sealed;

5. Heating and cooling systems, if installed at the time of the test, shall be turned off; and

6. Supply and return registers, if installed at the time of the test, shall be fully open.

N1102.4.1.2.2 (R402.4.1.2.2) Visual inspection option. Building envelope tightness shall be considered acceptable when the items listed in Table N1102.4.1.1, applicable to the method of construction, are field verified. Where required by the building official, an approved party, independent from the installer, shall inspect the air barrier.

N1102.4.1.3 (R402.4.1.3) Leakage rate (Prescriptive). The building or dwelling unit shall have an air leakage rate not exceeding 5 changes per hour as verified in accordance with Section N1102.4.1.2.

54. Change Section N1103.1.1 (R403.1.1) to read:

N1103.1.1 (R403.1.1) Programmable thermostat. The thermostat controlling the primary heating or cooling system of the dwelling unit shall be capable of controlling the heating and cooling system on a daily schedule to maintain different temperature set points at different times of the day. This thermostat shall include the capability to set back or temporarily operate the system to maintain zone temperatures down to 55°F (13°C) or up to 85°F (29°C). The thermostat shall initially be programmed with a heating temperature set point no higher than 70°F (21°C) and a cooling temperature set point no lower than 78°F (26°C).

57- 55. Change Section N1103.2.2 (R403.2.2) to read:

N1103.2.2 (R403.2.2) Sealing (Mandatory). ~~All ducts, Ducts, air handlers, and filter boxes and building cavities used as ducts~~ shall be sealed. Joints and seams shall comply with Section M1601.4.1 of the ~~International Residential Code~~ ~~this code~~. Verification of compliance with this section shall be in accordance with either Section N1103.2.2.1 or ~~Section~~ N1103.2.2.2.

Exceptions:

1. Air-impermeable spray foam products shall be permitted to be applied without additional joint seals.

2. Where a duct connection is made that is partially inaccessible, three screws or rivets shall be equally spaced on the exposed portion of the joint so as to prevent a hinge effect.

3. Continuously welded and locking-type longitudinal joints and seams in ducts operating at static pressures less than 2 inches of water column (500 Pa) pressure classification shall not require additional closure systems.

Regulations

~~58.~~ 56. Change Section N1103.2.2.1 (R403.2.2.1) to read:

N1103.2.2.1 (R403.2.2.1) Testing option. Duct tightness shall be verified by either of the following:

1. Post-construction test: ~~Leakage to outdoors~~ Total leakage shall be less than or equal to ~~eight 6 cfm (3.78 L/s) (169.9 L/min) per 100 ft² square feet (9.29 m²) of conditioned floor area or a total leakage less than or equal to 12 cfm (5.66 L/s) per 100 ft² (9.29m²) of conditioned floor area~~ when tested at a pressure differential of 0.1 inch w.g. (25 Pa) across the entire system, including the manufacturer's air handler ~~and enclosure enclosure~~. All register boots shall be taped or otherwise sealed during the test.

2. Rough-in test: Total leakage shall be less than or equal to ~~six 5 cfm (2.83 L/s) (141.5 L/min) per 100 ft² square feet (9.29 m²) of conditioned floor area~~ when tested at a pressure differential of 0.1 inch w.g. (25 Pa) across the ~~roughed-in~~ system, including the manufacturer's air handler enclosure. All register boots shall be taped or otherwise sealed during the test. If the air handler is not installed at the time of the test, total leakage shall be less than or equal to ~~4 5 cfm (1.89 L/s) (141.5 L/min) per 100 ft² square feet (9.29 m²) of conditioned floor area~~.

Exception: ~~Duct tightness~~ The total leakage test is not required if the for ducts and air handler and all ducts are handlers located entirely within conditioned space the building thermal envelope.

When this option is chosen, testing shall be performed by approved qualified individuals, testing agencies or contractors. Testing and results shall be as prescribed in Section N1103.2.2 and approved recognized industry standards.

~~59.~~ 57. Add Section N1103.2.2.2 (R403.2.2.2) to read:

N1103.2.2.2 (R403.2.2.2) Visual inspection option. In addition to the inspection of ducts otherwise required by this code, when the air handler and all ducts are not within conditioned space and this option is chosen to verify duct tightness, duct tightness shall be considered acceptable when the requirements of Section N1103.2.2 are field verified.

58. Add Section N1103.2.2.3 (R403.2.2.3) to read:

N1103.2.2.3 (R403.2.2.1) Sealed air handler. Air handlers shall have a manufacturer's designation for an air leakage of no more than 2.0% of the design air flow rate when tested in accordance with ASHRAE 193.

59. Change Section N1103.4.2 (R403.4.2) to read:

N1103.4.2 (R403.4.2) Hot water pipe insulation (Prescriptive). Insulation for hot water pipe with a minimum thermal resistance (R-value) of R-3 shall be applied to the following:

1. Piping larger than 3/4 inch nominal diameter.

2. Piping serving more than one dwelling unit.

3. Piping located outside the conditioned space.

4. Piping from the water heater to a distribution manifold.

5. Piping located under a floor slab.

6. Buried piping.

7. Supply and return piping in recirculation systems other than demand recirculation systems.

60. Delete Table N1103.4.2 (R403.4.2).

61. Change Section N1104.1 (R404.1) to read:

N1104.1 (R404.1) Lighting equipment (Mandatory). A minimum of 50% of the lamps in permanently installed luminaires shall be high-efficacy lamps, or a minimum of 50% of the permanently installed luminaires shall contain only high-efficacy lamps.

Exception: Low-voltage lighting shall not be required to utilize high-efficiency lamps.

62. Change the "Glazing" and "Air exchange rate" categories of Table N1105.5.2(1) (Table R405.5.2(1)) and add footnote "b-1" to read:

<u>Building Component</u>	<u>Standard Reference Design</u>	<u>Proposed Design</u>
<u>Glazing^a</u>	<u>Total area^b is 15% of the conditioned floor area.</u>	<u>As proposed</u>
<u>Glazing^a</u>	<u>Orientation: equally distributed to four cardinal compass orientations (North, East, South & West).</u>	<u>As proposed</u>
<u>Glazing^a</u>	<u>U-factor: from Table R402.1.3.</u>	<u>As proposed</u>
<u>Glazing^a</u>	<u>SHGC: From Table R402.1.1 except that for climates with no requirement (NR) SHGC = 0.40 shall be used.</u>	<u>As proposed</u>
<u>Glazing^a</u>	<u>Interior shade fraction: Summer (all hours when cooling is required) = 0.70. Winter (all hours when heating is required) = 0.85^{b-1}.</u>	<u>Same as standard referenced design^{b-1}</u>

Glazing ^a	External shading: <u>none.</u>	As proposed
<u>Air exchange rate</u>	<u>Air leakage rate of 5 air changes per hour at a pressure of 0.2 inches w.g (50 Pa). The mechanical ventilation rate shall be in addition to the air leakage rate and the same as in the proposed design, but no greater than $0.01 \times CFA + 7.5 \times (N_{br} + 1)$ where:</u> <u>CFA = conditioned floor area</u> <u>N_{br} = number of bedrooms</u> <u>Energy recovery shall not be assumed for mechanical ventilation.</u>	<u>For residences that are not tested, the same air leakage rate as the standard reference design. For tested residences, the measured air exchange rate^c. The mechanical ventilation rate^d shall be in addition to the air leakage rate and shall be as proposed.</u>
<u>b-1. For fenestrations facing within 15 degrees (0.26 rad) of true south that are directly coupled to thermal storage mass, the winter interior shade fraction shall be permitted to be increased to .095 in the proposed design.</u>		

~~62-~~ 64. Add Section G2425.1.1 to read:

G2425.1.1 Equipment changes. Upon the replacement or new installation of any fuel-burning appliances or equipment in existing buildings, an inspection or inspections shall be conducted to ensure that the connected vent or chimney systems comply with the following:

1. Vent or chimney systems are sized in accordance with this code.
2. Vent or chimney systems are clean, free of any obstruction or blockages, defects, or deterioration and are in operable condition.

Where not inspected by the local building department, persons performing such changes or installations shall certify to the building official that the requirements of Items 1 and 2 of this section are met.

~~63-~~ 65. Change Section P2601.2 to read:

P2601.2 Connections. Plumbing fixtures, drains and appliances used to receive or discharge liquid wastes or sewage shall be directly connected to the sanitary drainage system of the building or premises, in accordance with the requirements of this code. This section shall not be construed to prevent indirect waste systems.

Exception: Bathtubs, showers, lavatories, clothes washers and laundry trays ~~are shall~~ shall not be required to discharge to the sanitary drainage system where ~~those~~ such fixtures discharge to an approved nonpotable gray water ~~or rain~~ water recycling system in accordance with the applicable provisions of Sections P2909, P2910, and P2911.

~~64-~~ 66. Change Section P2602.1 to read:

P2602.1 General. The water and drainage system of any building or premises where plumbing fixtures are installed shall be connected to a public or private water supply and a public or private sewer system. As provided for in Section 103.11 of Part I of the Virginia Uniform Statewide Building Code (13VAC5-63) for functional design, water supply sources and sewage disposal systems are regulated and approved by the Virginia Department of Health and the Virginia Department of Environmental Quality.

Note: See also the Memorandums of Agreement in the "Related Laws Package," which is available from the Virginia Department of Housing and Community Development.

~~67-~~ Add Section P2901.1 to read:

P2901.1 Nonpotable fixtures and outlets. Nonpotable water shall be permitted to serve nonpotable type fixtures and outlets in accordance with the applicable provisions of Sections P2909, P2910, and P2911.

~~65-~~ 68. Change Section P2903.5 to read:

~~60.~~ Change Section M1502.4.4.1 to read:

~~M1502.4.4.1 Specified length. The maximum length of the exhaust duct shall be 35 feet (10 668 mm) from the connection to the transition duct from the dryer to the outlet terminal. Where fittings are used the maximum length of the exhaust duct shall be reduced in accordance with Table M1502.4.4.1.~~

~~61-~~ 63. Add Section M1801.1.1 to read:

M1801.1.1 Equipment changes. Upon the replacement or new installation of any fuel-burning appliances or equipment in existing buildings, an inspection or inspections shall be conducted to ensure that the connected vent or chimney systems comply with the following:

1. Vent or chimney systems are sized in accordance with this code.
2. Vent or chimney systems are clean, free of any obstruction or blockages, defects or deterioration and are in operable condition.

Where not inspected by the local building department, persons performing such changes or installations shall certify to the building official that the requirements of Items 1 and 2 of this section are met.

Regulations

P2903.5 Water hammer. The flow velocity of the water distribution system shall be controlled to reduce the possibility of water hammer. A water-hammer arrestor shall be installed where quick-closing valves are utilized, unless otherwise approved. Water hammer arrestors shall be installed in accordance with manufacturer's specifications. Water hammer arrestors shall conform to ASSE 1010.

~~66- 69.~~ Add Section P3002.2.1 to read:

P3002.2.1 Tracer wire. Nonmetallic sanitary sewer piping that discharges to public systems shall be locatable. An insulated copper tracer wire, 18 AWG minimum in size and suitable for direct burial or an equivalent product, shall be utilized. The wire shall be installed in the same trench as the sewer within 12 inches (305 mm) of the pipe and shall be installed from within five feet of the building wall to the point where the building sewer intersects with the public system. At a minimum, one end of the wire shall terminate above grade in an accessible location that is resistant to physical damage, such as with a cleanout or at the building wall.

70. Add an exception to Section P3301.1 to read:

Exception: Rainwater nonpotable water systems shall be permitted in accordance with the applicable provisions of Sections P2909 and 2911.

71. Add Section P2909 Nonpotable Water Systems.

72. Add Sections P2909.1 through P2909.18, including subsections, to read:

P2909.1 Scope. The provisions of this section shall govern the materials, design, construction, and installation of nonpotable water systems subject to this code.

P2909.1.1 Design of nonpotable water systems. All portions of nonpotable water systems subject to this code shall be constructed using the same standards and requirements for the potable water systems or drainage systems as provided for in this code unless otherwise specified in this section or Section P2910 or P2911, as applicable.

P2909.2 Makeup water. Makeup water shall be provided for all nonpotable water supply systems. The makeup water system shall be designed and installed to provide supply of water in the amounts and at the pressures specified in this code. The makeup water supply shall be potable and be protected against backflow in accordance with the applicable requirements of Section P2902.

P2909.2.1 Makeup water sources. Nonpotable water shall be permitted to serve as makeup water for gray water and rainwater systems.

P2909.2.2 Makeup water supply valve. A full-open valve shall be provided on the makeup water supply line.

P2909.2.3 Control valve alarm. Makeup water systems shall be fitted with a warning mechanism that alerts the user to a failure of the inlet control valve to close correctly. The alarm shall activate before the water within the storage tank begins to discharge into the overflow system.

P2909.3 Sizing. Nonpotable water distribution systems shall be designed and sized for peak demand in accordance with approved engineering practice methods that comply with the applicable provisions of this chapter.

P2909.4 Signage required. All nonpotable water outlets, other than water closets and urinals, such as hose connections, open ended pipes, and faucets shall be identified at the point of use for each outlet with signage that reads as follows: "Nonpotable water is utilized for (insert application name). Caution: nonpotable water. DO NOT DRINK." The words shall be legibly and indelibly printed on a tag or sign constructed of corrosion-resistant waterproof material or shall be indelibly printed on the fixture. The letters of the words shall be not less than 0.5 inches (12.7 mm) in height and in colors in contrast to the background on which they are applied. The pictograph shown in Figure P2909.4 shall appear on the signage required by this section.



P2909.5 Potable water supply system connections. Where a potable water supply system is connected to a nonpotable water system, the potable water supply shall be protected against backflow in accordance with the applicable provisions of Section P2902.

P2909.6 Nonpotable water system connections. Where a nonpotable water system is connected and supplies water to another nonpotable water system, the nonpotable water system that supplies water shall be protected against backflow in accordance with the applicable provisions of Section P2902.

P2909.7 Approved components and materials. Piping, plumbing components, and materials used in the nonpotable water drainage and distribution systems shall be approved for the intended application and compatible

with the water and any disinfection or treatment systems used.

P2909.8 Insect and vermin control. Nonpotable water systems shall be protected to prevent the entrance of insects and vermin into storage and piping systems. Screen materials shall be compatible with system material and shall not promote corrosion of system components.

P2909.9 Freeze protection. Nonpotable water systems shall be protected from freezing in accordance with the applicable provisions of Chapter 26.

P2909.10 Nonpotable water storage tanks. Nonpotable water storage tanks shall be approved for the intended application and comply with Sections P2909.10.1 through P2909.10.12.

P2909.10.1 Sizing. The holding capacity of storage tanks shall be sized for the intended use.

P2909.10.2 Inlets. Storage tank inlets shall be designed to introduce water into the tank and avoid agitating the contents of the storage tank. The water supply to storage tanks shall be controlled by fill valves or other automatic supply valves designed to stop the flow of incoming water before the tank contents reach the overflow pipes.

P2909.10.3 Outlets. Outlets shall be located at least 4 inches (102 mm) above the bottom of the storage tank and shall not skim water from the surface.

P2909.10.4 Materials and location. Storage tanks shall be constructed of material compatible with treatment systems used to treat water. Above grade storage vessels shall be constructed using opaque, UV-resistant materials such as tinted plastic, lined metal, concrete, or wood or painted to prevent algae growth. Above grade storage tanks shall be protected from direct sunlight unless their design specifically incorporates the use of the sunlight heat transfer. Wooden storage tanks shall be provided with a flexible liner. Storage tanks and their manholes shall not be located directly under soil or waste piping or sources of contamination.

P2909.10.5 Foundation and supports. Storage tanks shall be supported on a firm base capable of withstanding the storage tank's weight when filled to capacity. Storage tanks shall be supported in accordance with the applicable provisions of the IBC.

P2909.10.5.1 Ballast. Where the soil can become saturated, an underground storage tank shall be ballasted, or otherwise secured, to prevent the effects of buoyancy. The combined weight of the tank and hold down ballast shall meet or exceed the buoyancy force of the tank. Where the installation requires a foundation, the foundation shall be flat and shall be designed to support the storage tank weight when full, consistent with the bearing capability of adjacent soil.

P2909.10.5.2 Structural support. Where installed below grade, storage tank installations shall be designed to withstand earth and surface structural loads without damage.

P2909.10.6 Overflow. The storage tank shall be equipped with an overflow pipe having a diameter not less than that shown in Table P2909.10.6. The overflow outlet shall discharge at a point not less than 6 inches (152 mm) above the roof or roof drain, floor or floor drain, or over an open water-supplied fixture. The overflow outlet shall terminate through a check valve. Overflow pipes shall not be directed on walkways. The overflow drain shall not be equipped with a shutoff valve. A minimum of one cleanout shall be provided on each overflow pipe in accordance with the applicable provisions of Section P3005.2.

Tank Capacity (gallons)	Drain Pipe (inches)
Up to 750	1
751-1500	1-1/2
1501-3000	2
3001-5000	2-1/2
5001-7500	3
Over 7500	4

P2909.10.7 Access. A minimum of one access opening shall be provided to allow inspection and cleaning of the tank interior. Access openings shall have an approved locking device or other approved method of securing access. Below grade storage tanks, located outside of the building, shall be provided with either a manhole not less than 24 inches (610 mm) square or a manhole with an inside diameter not less than 24 inches (610 mm). The design and installation of access openings shall prohibit surface water from entering the tank. Each manhole cover shall have an approved locking device or other approved method of securing access.

Exception: Storage tanks under 800 gallons (3028 L) in volume installed below grade shall not be required to be equipped with a manhole, but shall have an access opening not less than 8 inches (203 mm) in diameter to allow inspection and cleaning of the tank interior.

P2909.10.8 Venting. Storage tanks shall be vented. Vents shall not be connected to the sanitary drainage system. Vents shall be at least equal in size to the internal diameter of the drainage inlet pipe or pipes connected to the tank. Where installed at grade, vents shall be protected from contamination by means of a U-bend

Regulations

installed with the opening directed downward. Vent outlets shall extend a minimum of 12 inches (304.8 mm) above grade, or as necessary to prevent surface water from entering the storage tank. Vent openings shall be protected against the entrance of vermin and insects. Vents serving gray water tanks shall terminate in accordance with the applicable provisions of Sections P3103 and P2909.8.

P2909.10.9 Drain. Where drains are provided, they shall be located at the lowest point of the storage tank. The tank drain pipe shall discharge as required for overflow pipes and shall not be smaller in size than specified in Table P2909.10.6. A minimum of one cleanout shall be provided on each drain pipe in accordance with Section P3005.2.

P2909.10.10 Labeling and signage. Each nonpotable water storage tank shall be labeled with its rated capacity and the location of the upstream bypass valve. Underground and otherwise concealed storage tanks shall be labeled at all access points. The label shall read: "CAUTION: NONPOTABLE WATER – DO NOT DRINK." Where an opening is provided that could allow the entry of personnel, the opening shall be marked with the words: "DANGER – CONFINED SPACE." Markings shall be indelibly printed on a tag or sign constructed of corrosion-resistant waterproof material mounted on the tank or shall be indelibly printed on the tank. The letters of the words shall be not less than 0.5 inches (12.7 mm) in height and shall be of a color in contrast with the background on which they are applied.

P2909.10.11 Storage tank tests. Storage tanks shall be tested in accordance with the following:

1. Storage tanks shall be filled with water to the overflow line prior to and during inspection. All seams and joints shall be left exposed and the tank shall remain water tight without leakage for a period of 24 hours.

2. After 24 hours, supplemental water shall be introduced for a period of 15 minutes to verify proper drainage of the overflow system and verify that there are no leaks.

3. Following a successful test of the overflow system, the water level in the tank shall be reduced to a level that is at 2 inches (50.8 mm) below the makeup water offset point. The tank drain shall be observed for proper operation. The makeup water system shall be observed for proper operation, and successful automatic shutoff of the system at the refill threshold shall be verified. Water shall not be drained from the overflow at any time during the refill test.

4. Air tests shall be permitted in lieu of water testing as recommended by the tank manufacturer or the tank standard.

P2909.10.12 Structural strength. Storage tanks shall meet the applicable structural strength requirements of the IBC.

P2909.11 Trenching requirements for nonpotable water system piping. Underground nonpotable water system piping shall be horizontally separated from the building sewer and potable water piping by 5 feet (1524 mm) of undisturbed or compacted earth. Nonpotable water system piping shall not be located in, under, or above sewage systems cesspools, septic tanks, septic tank drainage fields, or seepage pits. Buried nonpotable water system piping shall comply with the requirements of this code for the piping material installed.

Exceptions:

1. The required separation distance shall not apply where the bottom of the nonpotable water pipe within 5 feet (1524 mm) of the sewer is equal to or greater than 12 inches (305 mm) above the top of the highest point of the sewer and the pipe materials conforms to Table P3002.2.

2. The required separation distance shall not apply where the bottom of the potable water service pipe within 5 feet (1524 mm) of the nonpotable water pipe is a minimum of 12 inches (305 mm) above the top of the highest point of the nonpotable water pipe and the pipe materials comply with the requirements of Table P2905.5.

3. Nonpotable water pipe is permitted to be located in the same trench with building sewer piping, provided that such sewer piping is constructed of materials that comply with the requirements of Table P3002.1(2).

4. The required separation distance shall not apply where a nonpotable water pipe crosses a sewer pipe, provided that the pipe is sleeved to at least 5 feet (1524 mm) horizontally from the sewer pipe centerline on both sides of such crossing with pipe materials that comply with Table P3002.1(2).

5. The required separation distance shall not apply where a potable water service pipe crosses a nonpotable water pipe provided that the potable water service pipe is sleeved for a distance of at least 5 feet (1524 mm) horizontally from the centerline of the nonpotable pipe on both sides of such crossing with pipe materials that comply with Table P3002.1(2).

P2909.12 Outdoor outlet access. Sillcocks, hose bibs, wall hydrants, yard hydrants, and other outdoor outlets that are supplied by nonpotable water shall be located in a locked vault or shall be operable only by means of a removable key.

P2909.13 Drainage and vent piping and fittings. Nonpotable drainage and vent pipe and fittings shall comply with the applicable material standards and installation requirements in accordance with provisions of Chapter 30.

P2909.13.1. Labeling and marking. Identification of nonpotable drainage and vent piping shall not be required.

P2909.14 Pumping and control system. Mechanical equipment, including pumps, valves, and filters, shall be accessible and removable in order to perform repair, maintenance, and cleaning. The minimum flow rate and flow pressure delivered by the pumping system shall be designed for the intended application in accordance with the applicable provisions of Section P2903.

P2909.15 Water-pressure reducing valve or regulator. Where the water pressure supplied by the pumping system exceeds 80 psi (552 kPa) static, a pressure-reducing valve shall be installed to reduce the pressure in the nonpotable water distribution system piping to 80 psi (552 kPa) static or less. Pressure-reducing valves shall be specified and installed in accordance with the applicable provisions of Section P2903.3.1.

P2909.16 Distribution pipe. Distribution piping utilized in nonpotable water stems shall comply with Sections P2909.16.1 through P2909.16.4.

P2909.16.1 Materials, joints, and connections. Distribution piping and fittings shall comply with the applicable material standards and installation requirements in accordance with applicable provisions of Chapter 29.

P2909.16.2 Design. Distribution piping shall be designed and sized in accordance with the applicable provisions of Chapter 29.

P2909.16.3 Labeling and marking. Distribution piping labeling and marking shall comply with Section P2901.1.

P2909.16.4 Backflow prevention. Backflow preventers shall be installed in accordance with the applicable provisions of Section P2902.

P2909.17 Tests and inspections. Tests and inspections shall be performed in accordance with Sections P2909.17.1 through P2909.17.5.

P2909.17.1 Drainage and vent pipe test. Drain, waste, and vent piping used for gray water and rainwater nonpotable water systems shall be tested in accordance with the applicable provisions of Section P2503.

P2909.17.2 Storage tank test. Storage tanks shall be tested in accordance with the Section P2909.10.11.

P2909.17.3 Water supply system test. Nonpotable distribution piping shall be tested in accordance with Section P2503.7.

P2909.17.4 Inspection and testing of backflow prevention assemblies. The testing of backflow preventers and backwater valves shall be conducted in accordance with Section P2503.8.

P2909.17.5 Inspection of vermin and insect protection. Inlets and vent terminations shall be visually inspected to

verify that each termination is installed in accordance with Section P2909.10.8.

P2909.18 Operation and maintenance manuals. Operations and maintenance materials for nonpotable water systems shall be provided as prescribed by the system component manufacturers and supplied to the owner to be kept in a readily accessible location.

73. Add Section P2910 Gray Water Nonpotable Water Systems.

74. Add Sections P2910.1 through P2910.6, including subsections, to read:

P2910.1 Gray water nonpotable water systems. This code is applicable to the plumbing fixtures, piping or piping systems, storage tanks, drains, appurtenances, and appliances that are part of the distribution system for gray water within buildings and to storage tanks and associated piping that are part of the distribution system for gray water outside of buildings. This code does not regulate equipment used for, or the methods of, processing, filtering, or treating gray water, which may be regulated by the Virginia Department of Health or the Virginia Department of Environmental Quality.

P2910.1.1 Separate systems. Gray water nonpotable water systems, unless approved otherwise under the permit from the Virginia Department of Health, shall be separate from the potable water system of a building with no cross connections between the two systems except as permitted by the Virginia Department of Health.

P2910.2 Water quality. Each application of gray water reuse shall meet the minimum water quality requirements set forth in Sections P2910.2.1 through P2910.2.4 unless otherwise superseded by other state agencies.

P2910.2.1 Disinfection. Where the intended use or reuse application for nonpotable water requires disinfection or other treatment or both, it shall be disinfected as needed to ensure that the required water quality is delivered at the point of use or reuse.

P2910.2.2 Residual disinfectants. Where chlorine is used for disinfection, the nonpotable water shall contain not more than 4 parts per million (4 mg/L) of free chlorine, combined chlorine, or total chlorine. Where ozone is used for disinfection, the nonpotable water shall not exceed 0.1 parts per million (by volume) of ozone at the point of use.

P2910.2.3 Filtration. Water collected for reuse shall be filtered as required for the intended end use. Filters shall be accessible for inspection and maintenance. Filters shall utilize a pressure gauge or other approved method to indicate when a filter requires servicing or replacement. Shutoff valves installed immediately upstream and downstream of the filter shall be included to allow for isolation during maintenance.

Regulations

P2910.2.4 Filtration required. Gray water utilized for water closet and urinal flushing applications shall be filtered by a 100 micron or finer filter.

P2910.3 Storage tanks. Storage tanks utilized in gray water nonpotable water systems shall comply with Section P2909.10.

P2910.4 Retention time limits. Untreated gray water shall be retained in storage tanks for a maximum of 24 hours.

P2910.5 Tank Location. Storage tanks shall be located with a minimum horizontal distance between various elements as indicated in Table P2910.5.1.

<u>Element</u>	<u>Minimum Horizontal Distance from Storage Tank (feet)</u>
<u>Lot line adjoining private lots</u>	<u>5</u>
<u>Sewage systems</u>	<u>5</u>
<u>Septic tanks</u>	<u>5</u>
<u>Water wells</u>	<u>50</u>
<u>Streams and lakes</u>	<u>50</u>
<u>Water service</u>	<u>5</u>
<u>Public water main</u>	<u>10</u>

P2910.6 Valves. Valves shall be supplied on gray water nonpotable water drainage systems in accordance with Sections P2910.6.1 and P2910.6.2.

P2910.6.1 Bypass valve. One three-way diverter valve certified to NSF 50 or other approved device shall be installed on collection piping upstream of each storage tank, or drainfield, as applicable, to divert untreated gray water to the sanitary sewer to allow servicing and inspection of the system. Bypass valves shall be installed downstream of fixture traps and vent connections. Bypass valves shall be labeled to indicate the direction of flow, connection, and storage tank or drainfield connection. Bypass valves shall be provided with access for operation and maintenance. Two shutoff valves shall not be installed to serve as a bypass valve.

P2910.6.2 Backwater valve. Backwater valves shall be installed on each overflow and tank drain pipe to prevent unwanted water from draining back into the storage tank. If the overflow and drain piping arrangement is installed to physically not allow water to drain back into the tank, such as in the form of an air gap, backwater valves shall not be required. Backwater valves shall be constructed and installed in accordance with Section P3008.

75. Add Section P2911 Rainwater Nonpotable Water Systems.

76. Add Sections P2911.1 through P2911.10, including subsections, to read:

P2911.1 General. The provisions of this section shall govern the design, construction, installation, alteration, and repair of rainwater nonpotable water systems for the collection, storage, treatment, and distribution of rainwater for nonpotable applications.

P2911.2 Water quality. Each application of rainwater reuse shall meet the minimum water quality requirements set forth in Sections P2911.2.1 through P2911.2.4 unless otherwise superseded by other state agencies.

P2911.2.1 Disinfection. Where the intended use or reuse application for nonpotable water requires disinfection or other treatment or both, it shall be disinfected as needed to ensure that the required water quality is delivered at the point of use or reuse.

P2911.2.2 Residual disinfectants. Where chlorine is used for disinfection, the nonpotable water shall contain not more than 4 parts per million (4 mg/L) of free chlorine, combined chlorine, or total chlorine. Where ozone is used for disinfection, the nonpotable water shall not exceed 0.1 parts per million (by volume) of ozone at the point of use.

P2911.2.3 Filtration. Water collected for reuse shall be filtered as required for the intended end use. Filters shall be accessible for inspection and maintenance. Filters shall utilize a pressure gauge or other approved method to indicate when a filter requires servicing or replacement. Shutoff valves installed immediately upstream and downstream of the filter shall be included to allow for isolation during maintenance.

P2911.2.4 Filtration required. Rainwater utilized for water closet and urinal flushing applications shall be filtered by a 100 micron or finer filter.

P2911.3 Collection surface. Rainwater shall be collected only from aboveground impervious roofing surfaces constructed from approved materials. Overflow or discharge piping from appliances or equipment or both, including but not limited to evaporative coolers, water heaters, and solar water heaters shall not discharge onto rainwater collection surfaces.

P2911.4 Collection surface diversion. At a minimum, the first 0.04 inches (1.016 mm) of each rain event of 25 gallons (94.6 L) per 1000 square feet (92.9 m²) shall be diverted from the storage tank by automatic means and not require the operation of manually operated valves or devices. Diverted water shall not drain onto other collection surfaces that are discharging to the rainwater system or to the sanitary sewer. Such water shall be diverted from the storage tank and discharged in an approved location.

P2911.5 Pre-tank filtration. Downspouts, conductors, and leaders shall be connected to a pre-tank filtration device. The filtration device shall not permit materials larger than 0.015 inches (0.4 mm).

P2911.6 Roof gutters and downspouts. Gutters and downspouts shall be constructed of materials that are compatible with the collection surface and the rainwater quality for the desired end use. Joints shall be made watertight.

P2911.6.1 Slope. Roof gutters, leaders, and rainwater collection piping shall slope continuously toward collection inlets. Gutters and downspouts shall have a slope of not less than 1 unit in 96 units along their entire length, and shall not permit the collection or pooling of water at any point.

P2911.6.2 Size. Gutters and downspouts shall be installed and sized in accordance with local rainfall rates.

P2911.6.3 Cleanouts. Cleanouts or other approved openings shall be provided to permit access to all filters, flushes, pipes, and downspouts.

P2911.7 Storage tanks. Storage tanks utilized in rainwater nonpotable water systems shall comply with Section P2909.10.

P2911.8 Location. Storage tanks shall be located with a minimum horizontal distance between various elements as indicated in Table P2911.8.1.

<u>Table P2911.8.1</u> <u>Location of Rainwater Storage Tanks</u>	
<u>Element</u>	<u>Minimum Horizontal Distance from Storage Tank (feet)</u>
<u>Lot line adjoining private lots</u>	<u>5</u>
<u>Sewage systems</u>	<u>5</u>
<u>Septic tanks</u>	<u>5</u>

P2911.9 Valves. Valves shall be installed in collection and conveyance drainage piping of rainwater nonpotable water systems in accordance with Sections P2911.9.1 and P2911.9.2.

P2911.9.1 Influent diversion. A means shall be provided to divert storage tank influent to allow maintenance and repair of the storage tank system.

P2911.9.2 Backwater valve. Backwater valves shall be installed on each overflow and tank drain pipe to prevent unwanted water from draining back into the storage tank. If the overflow and drain piping arrangement is installed to physically not allow water to drain back into the tank, such as in the form of an air gap, backwater valves shall

not be required. Backwater valves shall be constructed and installed in accordance with Section P3008.

P2911.10 Tests and inspections. Tests and inspections shall be performed in accordance with Sections P2911.10.1 through P2911.10.2.

P2911.10.1 Roof gutter inspection and test. Roof gutters shall be inspected to verify that the installation and slope is in accordance with Section P2911.6.1. Gutters shall be tested by pouring a minimum of one gallon of water into the end of the gutter opposite the collection point. The gutter being tested shall not leak and shall not retain standing water.

P2911.10.2 Collection surface diversion test. A collection surface diversion test shall be performed by introducing water into the gutters or onto the collection surface area. Diversion of the first quantity of water in accordance with the requirements of Section P2911.4 shall be verified.

~~67- 77.~~ Add Section E3601.8 to read:

E3601.8 Energizing service equipment. The building official shall give permission to energize the electrical service equipment of a one- or two-family dwelling unit when all of the following requirements have been approved:

1. The service wiring and equipment, including the meter socket enclosure, shall be installed and the service wiring terminated.
2. The grounding electrode system shall be installed and terminated.
3. At least one receptacle outlet on a ground fault protected circuit shall be installed and the circuit wiring terminated.
4. Service equipment covers shall be installed.
5. The building roof covering shall be installed.
6. Temporary electrical service equipment shall be suitable for wet locations unless the interior is dry and protected from the weather.

~~68- 78.~~ Change Section E3802.4 to read:

E3802.4 In unfinished basements. Where ~~type~~ Type SE or NM cable is run at angles with joists in unfinished basements, cable assemblies containing two or more conductors of sizes 6 AWG and larger and assemblies containing three or more conductors of sizes 8 AWG and larger shall not require additional protection where attached directly to the bottom of the joists. Smaller cables shall be run either through bored holes in joists or on running boards. Type NM or SE cable installed on the wall of an unfinished basement shall be permitted to be installed in a listed conduit or tubing or shall be protected in accordance with Table E3802.1. Conduit or tubing shall be provided with a suitable insulating bushing or adapter at the point the where cable enters the raceway.

Regulations

The sheath of the Type NM or SE cable shall extend through the conduit or tubing and into the outlet or device box not less than 1/4 inch (6.4 mm). The cable shall be secured within 12 inches (305 mm) of the point where the cable enters the conduit or tubing. Metal conduit, tubing, and metal outlet boxes shall be connected to an equipment grounding conductor complying with Section E3908.13.

69- 79. Change Section ~~E3902.11~~ E3902.12 to read:

~~E3902.11~~ E3902.12 Arc-fault protection of bedroom outlets. All branch circuits that supply 120-volt, single phase, 15-ampere and 20-ampere outlets installed in bedrooms shall be protected by a combination type arc-fault circuit interrupter installed to provide protection of the branch circuit.

Exceptions:

1. Where a ~~combination~~ an outlet branch-circuit Type AFCI is installed at the first outlet to provide protection for the remaining portion of the branch circuit, the portion of the branch circuit between the branch-circuit overcurrent device and ~~such the first~~ outlet shall be ~~wired installed~~ with metal outlet and junction boxes and RMC, IMC, EMT, Type MC or steel armored cable, Type AC cables meeting the requirements of Section E3908.8.

2. Where an outlet branch-circuit Type AFCI is installed at the first outlet to provide protection for the remaining portion of the branch circuit, the portion of the branch circuit between the branch-circuit overcurrent device and the first outlet shall be installed with metal or nonmetallic conduit or tubing that is encased in not less than 2 inches (51 mm) of concrete.

3. AFCI protection is not required for a ~~a~~ an individual branch circuit supplying only a fire alarm system where the branch circuit is wired with metal outlet and junction boxes and RMC, IMC, EMT or ~~steel~~ steel-sheathed armored cable Type AC, or Type MC meeting the requirements of Section E3908.8.

80. Add the following referenced standards to Chapter 44:

<u>Standard Reference Number</u>	<u>Title</u>	<u>Referenced in Code Section Number</u>
<u>ICC ISPSC-12</u>	<u>International Swimming Pool and Spa Code</u>	<u>R325.1</u>
<u>NFPA 13R-10</u>	<u>Installation of Sprinkler Systems in Residential Occupancies Up to and Including Four Stories in Height</u>	<u>R310.1</u>

<u>NSF/ANSI 50-09</u>	<u>Equipment for Swimming Pools, Spas, Hot Tubs and Other Recreational Water Facilities</u>	<u>P2910.6.1</u>
-----------------------	---	------------------

S. Add "Marinas" to the list of occupancies in Section 312.1 of the IBC.

13VAC5-63-220. Chapter 4 Special detailed requirements based on use and occupancy.

A. Delete Section 403.4.4 of the IBC.

B. Add Change Section ~~407.10~~ to 407.4.1.1 of the IBC to read:

~~407.10~~ 407.4.1.1 Special locking arrangement. Means of egress doors shall be permitted to contain locking devices restricting the means of egress in areas in which the clinical needs of the patients require restraint of movement, where all of the following conditions are met:

1. The locks release upon activation of the fire alarm system or the loss of power.
2. The building is equipped with an approved automatic sprinkler system in accordance with Section 903.3.1.1.
3. A manual release device is provided at a nursing station responsible for the area.
4. A key-operated switch or other manual device is provided adjacent to each door equipped with the locking device. Such switch or other device, when operated, shall result in direct interruption of power to the lock -- independent of the control system electronics.
5. All staff shall have keys or other means to unlock the switch or other device or each door provided with the locking device.

C. Add Section 407.11 to the IBC to read:

407.11 Emergency power systems. Emergency power shall be provided for medical life support equipment, operating, recovery, intensive care, emergency rooms, fire detection and alarm systems in any Group I-2 occupancy licensed by the Virginia Department of Health as a hospital, nursing home or hospice facility.

D. Change the title Section 408.6 of the IBC ~~Section 410~~ to read:

~~Stages, Platforms and Technical Production Areas.~~

E. Delete the following definitions in IBC Section 410.2:

~~Fly gallery.~~

~~Gridiron.~~

F. Add the following definition to IBC Section 410.2 to read:

~~Technical production area. Open elevated areas or spaces intended for entertainment technicians to walk on and occupy for servicing and operating entertainment technology systems and equipment. Galleries, including fly~~

and lighting galleries, gridirons, catwalks and similar areas are designed for these purposes.

~~G. Delete Section 410.5.3 of the IBC, add new Section 410.6 to the IBC and renumber Sections 410.6 and 410.7 of the IBC to Sections 410.7 and 410.8 respectively.~~

~~410.6 Means of egress. Except as modified or as provided for in this section, the provisions of Chapter 10 shall apply.~~

~~410.6.1 Arrangement. Where two or more exits or exit access doorways are required per Section 1015.1 from the stage, at least one exit or exit access doorway shall be provided on each side of the stage.~~

~~410.6.2 Stairway and ramp enclosure. Stairways and ramps provided from stages, platforms and technical production areas are not required to be enclosed.~~

~~410.6.3 Technical production areas. Technical production areas shall be provided with means of egress and means of escape in accordance with Section 410.6.3.1 through 410.6.3.5.~~

~~410.6.3.1 Means of egress. At least one means of egress shall be provided from technical production areas.~~

~~410.6.3.2 Travel distance. The maximum length of exit access travel shall not exceed 300 feet (91 440 mm) for buildings without a sprinkler system and 400 feet (121 920 mm) for buildings equipped throughout with an automatic sprinkler system in accordance with Section 903.3.1.1.~~

~~410.6.3.3 Two means of egress. Where two means of egress are required, the common path of travel shall not exceed 100 feet (30 480 mm).~~

~~Exception: A means of egress to a roof in place of a second means of egress is permitted.~~

~~410.6.3.4 Path of egress travel. The following exit access components are permitted when serving technical production areas:~~

- ~~1. Stairways.~~
- ~~2. Ramps.~~
- ~~3. Spiral stairways.~~
- ~~4. Catwalks.~~
- ~~5. Alternating tread devices.~~
- ~~6. Permanent ladders.~~

~~410.6.3.5 Width. The path of egress travel within and from technical production areas shall be a minimum of 22 inches (559 mm).~~

~~408.6 Smoke barrier. Occupancies classified as Group I-3 shall have smoke barriers complying with Sections 408.8 and 709 to divide every story occupied by residents for sleeping, or any other story having an occupant load of 50 or more persons, into no fewer than two smoke compartments.~~

E. Change Section 408.9 of the IBC and add Sections 408.9.1 through 408.9.3 to the IBC to read:

408.9 Smoke control. Smoke control for each smoke compartment shall be in accordance with Sections 408.9.1 through 408.9.3.

Exception: Smoke compartments with operable windows or windows that are readily breakable.

408.9.1 Locations. An engineered smoke control system shall comply with Section 909 and shall be provided in the following locations:

1. Dormitory areas.
2. Celled areas.
3. General housing areas.
4. Intake areas.
5. Medical celled or medical dormitory areas.
6. Interior recreation areas.

408.9.2 Compliance. The engineered smoke control system shall provide and maintain a tenable environment in the area of origin and shall comply with all of the following:

1. Shall facilitate the timely evacuation and relocation of occupants from the area of origin.
2. Shall be independent of exhaust systems under Chapter 5 of the IMC.
3. Duration of operation in accordance with Section 909.4.6.
4. The pressurization method shall be permitted and shall provide a minimum of 24 air changes per hour of exhaust, and 20 air changes per hour of makeup, and shall comply with Section 909.6. If the pressurization method is not utilized, the exhaust method shall be provided and shall comply with Section 909.8.

408.9.3 Corridors. Egress corridors within smoke compartments shall be kept free and clear of smoke.

H. F. Add Section 415.1.1 to the IBC to read:

415.1.1 Flammable and combustible liquids. Notwithstanding the provisions of this chapter, Construction associated with the storage, handling, processing, and transporting of flammable and combustible liquids shall be in accordance with the mechanical code and the fire code listed in Chapter 35 of this code. Regulations and regulations governing the installation, repair, upgrade, and closure of underground and aboveground storage tanks under the Virginia State Water Control Board regulations 9VAC25-91 and 9VAC25-580, which are hereby adopted and incorporated by reference to be an enforceable part of this code. Where differences occur between the provisions of this code and the incorporated provisions of the such State Water Control Board regulations, the provisions of the State Water Control Board regulations shall apply.

G. Change the title of Section 420 and change Sections 420.1 and 420.4 of the IBC to read:

Section 420 Groups I-1, R-1, R-2, R-3, and R-4.

Regulations

420.1 General. Occupancies in Groups I-1, R-1, R-2, R-3, and R-4 shall comply with the provisions of Sections 420.1 through 420.6 and other applicable provisions of this code.

420.4 Smoke barriers in Group I-1 Condition 2. Smoke barriers shall be provided in Group I-1 Condition 2 to subdivide every story used by persons receiving care or treatment or sleeping and to divide other stories, with an occupant load of 50 or more persons, into no fewer than two smoke compartments. Such stories shall be divided into smoke compartments with an area of not more than 22,500 square feet (2092 m²) and the travel distance from any point in a smoke compartment to a smoke barrier door shall not exceed 200 feet (60 960 mm). The smoke barrier shall be in accordance with Section 709.

H. Add Section 420.4.1 to the IBC to read:

420.4.1 Refuge area. Refuge areas shall be provided within each smoke compartment. The size of the refuge area shall accommodate the occupants and care recipients from the adjoining smoke compartment. Where a smoke compartment is adjoined by two or more smoke compartments, the minimum area of the refuge area shall accommodate the largest occupant load of the adjoining compartments. The size of the refuge area shall provide the following:

1. Not less than 15 net square feet (1.4 m²) for each care recipient.
2. Not less than 6 net square feet (0.56 m²) for other occupants.

Areas or spaces permitted to be included in the calculation of the refuge area are corridors, lounge, or dining areas and other low hazard areas.

I. Change Section 420.5 of the IBC and add Section 420.6 to the IBC to read:

420.5 Automatic sprinkler system. Group R occupancies shall be equipped throughout with an automatic sprinkler system in accordance with Section 903.2.8. Group I-1 occupancies shall be equipped throughout with an automatic sprinkler system in accordance with Section 903.2.6. Quick response or residential automatic sprinklers shall be installed in accordance with Section 903.3.2.

420.6 Fire alarm systems and smoke alarms. Fire alarm systems and smoke alarms shall be provided in Groups I-1, R-1, R-2, and R-4 occupancies in accordance with Sections 907.2.6, 907.2.8, 907.2.9, and 907.2.10, respectively. Single-station or multiple-station smoke alarms shall be provided in Groups I-1, R-2, R-3, and R-4 in accordance with Section 907.2.11.

†. J. Add IBC Section 424 425 Manufactured Homes and Industrialized Buildings.

‡. K. Add Section 424.1 425.1 to the IBC to read:

424.1 425.1 General. The provisions of this section shall apply to the installation or erection of manufactured homes

subject to the Virginia Manufactured Home Safety Regulations (13VAC5-95) and industrialized buildings subject to the Virginia Industrialized Building Safety Regulations (13VAC5-91).

K. L. Add Section 424.2 425.2 to the IBC to read:

424.2 425.2 Site work for manufactured homes. The aspects for the installation and set up of a new manufactured home covered by this code rather than the Virginia Manufactured Home Safety Regulations (13VAC5 95) include, but are not limited to, footings, foundations systems, anchoring of the home, exterior, interior close up, and additions and alterations done during initial installation. Such aspects shall be subject to and shall comply with the manufacturer's installation instructions provided by the manufacturer of the home. To the extent that the manufacturer's installation instructions do not address any aspect enumerated above or when the manufacturer's installation instructions are not available, such aspects shall be subject to and comply with 24 CFR Part 3285 Model Manufactured Home Installation Standards. To the extent that the manufacturer's installation instructions and 24 CFR Part 3285 do not address any aspect enumerated above, the installer must first attempt to obtain Design Approval Primary Inspection Agency (DAPIA) as defined in 24 CFR Part 3285.5, approved designs and instructions prepared by the manufacturer; or if designs and instructions are not available from the manufacturer, obtain an alternate design prepared and certified by an RDP that is consistent with the manufactured home design, conforms to the requirements of the Manufactured Housing Consensus Committee (MHCCS) as defined in 24 CFR Part 3285.5, and has been approved by the manufacturer and the DAPIA. Stoops, decks, porches and used manufactured homes Footing design, basements, grading, drainage, decks, stoops, porches and utility connections shall comply with the applicable provisions of this code, which shall include the option of using the IRC for the technical requirements for the installation and set up of the home and the use of Appendix E of the IRC for additions, alterations and repairs to the home. Additionally, all applicable provisions of Chapter 1 of this code, including but not limited to requirements for permits, inspections, certificates of occupancy and requiring compliance, are applicable to the installation and set up set-up of a manufactured home. Where the installation or erection of a manufactured home utilizes components that are to be concealed, the installer shall notify the building official that an inspection is necessary and assure that an inspection is performed and approved prior to concealment of such components, unless the building official has agreed to an alternative method of verification.

M. Add Section 425.2.1 to the IBC to read:

425.2.1 Relocated manufactured homes. Installation, set-up, and site work for relocated manufactured homes shall comply with the provisions of this code and shall include the option of using the manufacturer's installation instructions or the federal Model Manufactured Home Installation Standards (24 CFR Part 3285) for the technical requirements.

N. Add Section 425.2.2 to the IBC to read:

425.2.2 Alterations and repairs to manufactured homes. Alterations and repairs to manufactured homes shall either be in accordance with federal Manufactured Home Construction and Safety Standards (24 CFR Part 3280) or in accordance with the alteration and repair provisions this code.

O. Add Section 425.2.3 to the IBC to read:

425.2.3 Additions to manufactured homes. Additions to manufactured homes shall comply with this code and shall be structurally independent of the manufactured home, or when not structurally independent, shall be evaluated by an RDP to determine that the addition does not cause the manufactured home to become out of compliance with federal Manufactured Home Construction and Safety Standards (24 CFR Part 3280).

~~L.~~ P. Add Section ~~424.3~~ 425.3 to the IBC to read:

~~424.3~~ 425.3 Wind load requirements for manufactured homes. Manufactured homes shall be anchored to withstand the wind loads established by the federal regulation for the area in which the manufactured home is installed. For the purpose of this code, Wind Zone II of the federal regulation shall include the cities of Chesapeake, Norfolk, Portsmouth, and Virginia Beach.

~~M.~~ Q. Add Section ~~424.4~~ 425.4 to the IBC to read:

~~424.4~~ 425.4 Skirting requirements for manufactured homes. As used in this section, "skirting" means a weather-resistant material used to enclose the space from the bottom of the manufactured home to grade. In accordance with § 36-99.8 of the Code of Virginia, manufactured homes installed or relocated shall have skirting installed within 60 days of occupancy of the home. Skirting materials shall be durable, suitable for exterior exposures and installed in accordance with the manufacturer's installation instructions. Skirting shall be secured as necessary to ensure stability, to minimize vibrations, to minimize susceptibility to wind damage and to compensate for possible frost heave. Each manufactured home shall have a minimum of one opening in the skirting providing access to any water supply or sewer drain connections under the home. Such openings shall be a minimum of 18 inches (457 mm) in any dimension and not less than three square feet (.28 m²) in area. The access panel or door shall not be fastened in a manner requiring the use of a special tool to open or remove the panel or door. On-site

fabrication of the skirting by the owner or installer of the home shall be acceptable, provided that the material meets the requirements of this code. In addition, as a requirement of this code, skirting for the installation and set-up of a new manufactured home shall also comply with the requirements of 24 CFR Part 3285 – Model Manufactured Home Installation Standards.

~~N.~~ R. Add Section ~~424.5~~ 425.5 to the IBC to read:

~~424.5~~ 425.5 Site work for industrialized buildings. Site work for the erection and installation of an industrialized building shall comply with the manufacturer's installation instructions. To the extent that any aspect of the erection or installation of an industrialized building is not covered by the manufacturer's installation instructions, this code shall be applicable, including the use of the IRC for any construction work where the industrialized building would be classified as a Group R-5 building. In addition, all administrative requirements of this code for permits, inspections, and certificates of occupancy are also applicable. Further, the building official may require the submission of plans and specifications for details of items needed to comprise the finished building that are not included or specified in the manufacturer's instructions, including, but not limited to, footings, foundations, supporting structures, proper anchorage, and the completion of the plumbing, mechanical, and electrical systems. Where the installation or erection of an industrialized building utilizes components that are to be concealed, the installer shall notify the building official that an inspection is necessary and assure that an inspection is performed and approved prior to concealment of such components, unless the building official has agreed to an alternative method of verification.

Exception: Temporary family health care structures installed pursuant to § 15.2-2292.1 of the Code of Virginia shall not be required or permitted to be placed on a permanent foundation, but shall otherwise remain subject to all pertinent provisions of this section.

~~O.~~ S. Add Section ~~424.6~~ 425.6 to the IBC to read:

~~424.6~~ 425.6 Relocated industrialized buildings; alterations and additions. Industrialized buildings constructed prior to January 1, 1972, shall be subject to Section 117 when relocated. Alterations and additions to any existing industrialized buildings shall be subject to pertinent provisions of this code. Building officials shall be permitted to require the submission of plans and specifications for the model to aid in the evaluation of the proposed alteration or addition. Such plans and specifications shall be permitted to be submitted in electronic or other available format acceptable to the building official.

T. Add Section 425.7 to the IBC to read:

425.7 Change of occupancy of industrialized buildings. Change of occupancy of industrialized buildings is

Regulations

regulated by the Virginia Industrialized Building Safety Regulations (13VAC5-91). When the industrialized building complies with those regulations for the new occupancy, the building official shall issue a new certificate of occupancy under the USBC.

~~P. U.~~ Add IBC Section ~~425.4~~ 426 Aboveground Liquid Fertilizer Tanks.

~~Q. V.~~ Add Sections ~~425.4~~ 426.1 through ~~425.6~~ 426.6 to the IBC to read:

~~425.4~~ 426.1 General. This section shall apply to the construction of ALFSTs and shall supersede any conflicting requirements in other provisions of this code. ALFSTs shall also comply with any applicable ~~non-conflicting~~ nonconflicting requirements of this code.

~~425.4.1~~ 426.1.1 When change of occupancy rules apply. A change of occupancy to use a tank as an ALFST occurs when there is a change in the use of a tank from storing liquids other than liquid fertilizers to a use of storing liquid fertilizer and when the type of liquid fertilizer being stored has a difference of at least 20% of the specific gravity or operating temperature, or both, or a significant change in the material's compatibility.

~~425.2~~ 426.2 Standards. Newly constructed welded steel ALFSTs shall comply with API 650 and TFI RMIP, as applicable. Newly constructed ALFSTs constructed of materials other than welded steel shall be constructed in accordance with accepted engineering practice to prevent the discharge of liquid fertilizer and shall be constructed of materials that are resistant to corrosion, puncture or cracking. In addition, newly constructed ALFSTs constructed of materials other than welded steel shall comply with TFI RMIP, as applicable. For the purposes of this code, the use of TFI RMIP shall be construed as mandatory and any language in TFI RMIP, such as, but not limited to, the terms "should" or "may" which indicate that a provision is only a recommendation or a guideline shall be taken as a requirement. ALFSTs shall be placarded in accordance with NFPA 704.

Exception: Sections 4.1.4, 4.2.5, 5.1.2, 5.2.8, 5.3 and 8.1(d)(i) of TFI RMIP shall not be construed as mandatory.

~~425.3~~ 426.3 Secondary containment. When ALFSTs are newly constructed and when there is a change of occupancy to use a tank as an ALFST, a secondary containment system designed and constructed to prevent any liquid fertilizer from reaching the surface water, groundwater or adjacent land before cleanup occurs shall be provided. The secondary containment system may include dikes, berms or retaining walls, curbing, diversion ponds, holding tanks, sumps, vaults, double-walled tanks, liners external to the tank, or other approved means and shall be capable of holding up to 110% of the capacity of the ALFST as certified by an RDP.

~~425.4~~ 426.4 Repair, alteration and reconstruction of ALFSTs. Repair, alteration and reconstruction of ALFSTs shall comply with applicable provisions of API 653 and TFI RMIP.

~~425.5~~ 426.5 Inspection. Applicable inspections as required by and in accordance with API 653 and TFI RMIP shall be performed for repairs and alterations to ALFSTs, the reconstruction of ALFSTs and when there is a change of occupancy to use a tank as an ALFST. When required by API 653 or TFI RMIP, such inspections shall occur prior to the use of the ALFST.

~~425.6~~ 426.6 Abandoned ALFSTs. Abandoned ALFSTs shall comply with applicable provisions of Section ~~3404.2.13.2~~ 5704.2.13.2 of the IFC.

13VAC5-63-225. Chapter 5 General building heights and areas.

A. Change Section 504.2 of the IBC to read:

504.2 Automatic sprinkler system increase. Where a building is equipped throughout with an approved automatic sprinkler system in accordance with Section 903.3.1.1, the value specified in Table 503 for maximum building height is increased by 20 feet (6096 mm) and the maximum number of stories is increased by one. These increases are permitted in addition to the building area increase in accordance with Sections 506.2 and 506.3. For Group R buildings equipped throughout with an approved automatic sprinkler system in accordance with Section 903.3.1.2, the value specified in Table 503 for maximum building height is increased by 20 feet (6096 mm) and the maximum number of stories is increased by one, but shall not exceed 60 feet (18 288 mm) or four stories, respectively.

Exception: The use of an automatic sprinkler system to increase building heights shall not be permitted for the following conditions:

1. Buildings, or portions of buildings, classified as Group I-1 Condition 2, of Type IIB, III, IV, or V construction or Group I-2 occupancies of Type IIB, III, IV, or V construction.

2. Buildings, or portions of buildings, classified as a Group H-1, H-2, H-3, or H-5 occupancy.

3. Buildings where an automatic sprinkler system is substituted for fire-resistance rated construction in accordance with Table 601, Note d.

B. Change Section 508.2.3 of the IBC to read:

508.2.3 Allowable building area and height. The allowable building area and height of the building containing accessory occupancies shall be based on the allowable building area and height for the main occupancy in accordance with Section 503.1. The building area of the accessory occupancies shall be in accordance with Section 508.2.1.

13VAC5-63-230. Chapter 7 Fire-resistant-rated construction Fire and smoke protection features.

A. Change Section ~~703.6~~ 703.7 of the IBC to read:

~~703.6~~ 703.7 Fire-resistance assembly marking. ~~Concealed~~ Where there is a concealed floor, floor-ceiling, or attic space, the fire walls, vertical fire separation assemblies, fire barriers, fire partitions and, smoke barriers, or any other wall required to have protected openings or penetrations shall be designated above ceilings and on the inside of all ceiling access doors which that provide access to such fire rated assemblies by signage having letters no smaller than one inch (25.4 mm) in height. Such signage shall indicate the fire-resistance rating of the assembly and the type of assembly and be provided at horizontal intervals of no more than eight feet (2438 mm).

Note: An example of suggested formatting for the signage would be "ONE HOUR FIRE PARTITION."

B. Change the exceptions to Section 705.2 of the IBC to read:

~~705.2 Projections. Except for decks and open porches of buildings in Groups R-3 and R-4, cornices, eave overhangs, exterior balconies and similar projections extending beyond the exterior wall shall conform to the requirements of this section and Section 1406. Exterior egress balconies and exterior exit stairways shall also comply with Sections 1019 and 1026, respectively. Projections shall not extend beyond the distance determined by the following three methods, whichever results in the lesser projection:~~

~~1. A point one third the distance from the exterior face of the wall to the lot line where protected openings or a combination of protected and unprotected openings are required in the exterior wall.~~

~~2. A point one half the distance from the exterior face of the wall to the lot line where all openings in the exterior wall are permitted to be unprotected or the building is equipped throughout with an automatic sprinkler system installed under the provisions of Section 705.8.2.~~

~~3. More than 12 inches (305 mm) into areas where openings are prohibited.~~

Exceptions:

~~1. Buildings on the same lot and considered as portions of one building in accordance with Section 705.3 are not required to comply with this section.~~

~~2. Decks and open porches of buildings of Groups R-3 and R-4.~~

C. Add Exception 4 to Section 706.5.2 of the IBC to read:

~~4. Decks and open porches of buildings in Groups R-3 and R-4.~~

D. Change Section 709.5 of the IBC to read:

709.5 Openings. Openings in a smoke barrier shall be protected in accordance with Section 716.

Exceptions:

1. In Group I-1 Condition 2, Group I-2, and ambulatory care facilities where doors are installed across corridors, a pair of opposite-swinging doors without a center mullion shall be installed having vision panels with fire-protection-rated glazing materials in fire-protection-rated frames, the area of which shall not exceed that tested. The doors shall be close fitting within operational tolerances and shall not have undercuts in excess of 3/4-inch, louvers, or grilles. The doors shall have head and jamb stops, astragals, or rabbets at meeting edges and shall be automatic-closing by smoke detection in accordance with Section 716.5.9.3. Where permitted by the door manufacturer's listing, positive-latching devices are not required.

2. In Group I-1 Condition 2, Group I-2, and ambulatory care facilities, horizontal sliding doors installed in accordance with Section 1008.1.4.3 and protected in accordance with Section 716.

~~E. Delete Sections 708.14.1 through 708.14.2.11 713.14.1 and 713.14.1.1.~~

~~E. F. Change Section 716.5.3 716.5.3.1 of the IBC to read:~~

~~716.5.3 Penetrations of shaft enclosures. Shaft enclosures that are permitted to be penetrated by ducts and air transfer openings shall be protected with approved fire and smoke dampers installed in accordance with their listing.~~

Exceptions:

~~1. Fire and smoke dampers are not required where steel exhaust subducts extend at least 22 inches (559 mm) vertically in exhaust shafts provided there is a continuous airflow upward to the outside.~~

~~2. Fire dampers are not required where penetrations are tested in accordance with ASTM E 119 as part of the fire resistance rated assembly.~~

~~3. Fire and smoke dampers are not required where ducts are used as part of an approved smoke control system in accordance with Section 909.~~

~~4. Fire and smoke dampers are not required where the penetrations are in parking garage exhaust or supply shafts that are separated from other building shafts by not less than two-hour fire resistance rated construction.~~

~~5. Smoke dampers are not required where the building is equipped throughout with an automatic sprinkler system in accordance with Section 903.3.1.1.~~

716.5.3.1 Smoke and draft control. Fire door assemblies located in smoke barrier walls shall also meet the requirements for a smoke and draft control door assembly tested in accordance with UL 1784. The air leakage rate of the door assembly shall not exceed 3.0 cubic feet per minute per square foot (0.01524 m³/s · m²) of door opening at 0.10 inch (24.9 Pa) of water for both the ambient temperature and elevated temperature tests. Louvers shall

Regulations

be prohibited. Installation of smoke doors shall be in accordance with NFPA 105.

13VAC5-63-235. Chapter 8 Interior finishes.

Change Section 806.1.2 of the IBC to read:

806.1.2 Combustible decorative materials. The permissible amount of decorative materials meeting the flame propagation performance criteria of NFPA 701 shall not exceed 10% of the specific wall or ceiling area to which it is attached.

Exceptions:

1. In auditoriums or similar types of spaces in Group A, the permissible amount of decorative material meeting the flame propagation performance criteria of NFPA 701 shall not exceed 75% of the aggregate wall area where the building is equipped throughout with an automatic sprinkler system in accordance with Section 903.3.1.1 and where the material is installed in accordance with Section 803.11.

2. In auditoriums or similar types of spaces in Group A, the permissible amount of decorative materials suspended from the ceiling, located no more than 12 inches (305 mm) from the wall, not supported by the floor, and meeting the flame propagation performance criteria of NFPA 701, shall not exceed 75% of the aggregate wall area when the building is equipped throughout with an automatic sprinkler system in accordance with Section 903.3.1.1.

3. The amount of fabric partitions suspended from the ceiling and not supported by the floor in Groups B and M occupancies shall not be limited.

13VAC5-63-240. Chapter 9 Fire protection systems.

A. Add the following definitions to the list of terms in Section ~~902~~ 902.1 of the IBC ~~to read:~~

~~Emergency communication equipment. Emergency communication equipment, includes but is not limited to, two-way radio communications, signal booster, bi-directional amplifiers, radiating cable systems or internal multiple antenna, or a combination of the foregoing.~~

~~Emergency public safety personnel. Emergency public safety personnel includes firefighters, emergency medical personnel, law enforcement officers and other emergency public safety personnel routinely called upon to provide emergency assistance to members of the public in a wide variety of emergency situations, including, but not limited to, fires, medical emergencies, violent crimes and terrorist attacks.~~

~~B. Change the following definition in Section 902 of the IBC to read:~~

~~Automatic fire extinguishing system. An approved system of devices and equipment which automatically detects a fire and discharges an approved fire extinguishing agent onto or in the area of a fire and shall include among other~~

~~systems an automatic sprinkler system, unless otherwise expressly stated.~~

~~C. B.~~ Change Section 903.2.1.2 of the IBC to read:

903.2.1.2 Group A-2. An automatic sprinkler system shall be provided for Group A-2 occupancies where one of the following conditions exists:

1. The fire area exceeds 5,000 square feet (464.5m²);
2. The fire area has an occupant load of 100 or more in night clubs or 300 or more in other Group A-2 occupancies; or
3. The fire area is located on a floor other than a level of exit discharge serving such occupancies.

~~D. C.~~ Change Item 2 of Section 903.2.1.3 of the IBC to read:

~~2. In Group A-3 occupancies other than churches places of religious worship, the fire area has an occupant load of 300 or more; or~~

~~E. D.~~ Change Section 903.2.3 of the IBC to read:

903.2.3 Group E. An automatic sprinkler system shall be provided for Group E occupancies as follows:

1. Throughout all Group E fire areas greater than 20,000 square feet (1858 m²) in area.
2. Throughout every portion of educational buildings below the lowest level of exit discharge serving that portion of the building.

Exception: An automatic sprinkler system is not required in any area below the lowest level of exit discharge serving that area where every classroom throughout the building has at least one exterior exit door at ground level.

~~F. E.~~ Change Section 903.2.7 of the IBC to read:

903.2.7 Group M. An automatic sprinkler system shall be provided throughout buildings containing a Group M occupancy where one of the following conditions exists:

1. A Group M fire area exceeds 12,000 square feet (1115 m²).
2. A Group M fire area is located more than three stories above grade plane.
3. The combined area of all Group M fire areas on all floors, including any mezzanines, exceeds 24,000 square feet (2230 m²).

~~G. F.~~ Change ~~Section~~ Sections 903.2.8, 903.2.8.1, and 908.2.8.2 of the IBC to read:

~~903.2.7~~ 903.2.8 Group R. An automatic sprinkler system installed in accordance with Section 903.3 shall be provided throughout all buildings with a Group R fire area, except ~~in the following~~ for Group R-2 occupancies listed in the exceptions to this section when the necessary water pressure or volume, or both, for the system is not available:

Exceptions:

1. ~~Buildings which~~ Group R-2 occupancies that do not exceed two stories, including basements ~~which that~~ are not

considered as a story above grade, and with a maximum of 16 dwelling units per fire area. Each dwelling unit shall have at least one door opening to an exterior exit access that leads directly to the exits required to serve that dwelling unit.

2. ~~Buildings~~ Group R-2 occupancies where all dwelling units are not more than two stories above the lowest level of exit discharge and not more than one story below the highest level of exit discharge of exits serving the dwelling unit and a two-hour fire barrier is provided between each pair of dwelling units. Each bedroom of a dormitory or boarding house shall be considered a dwelling unit under this exception.

903.2.8.1 Group R-3. An automatic sprinkler system installed in accordance with Section 903.3.1.3 shall be permitted in Group R-3.

903.2.8.2 Group R-4 Condition 1. An automatic sprinkler system installed in accordance with Section 903.3.1.3 shall be permitted in Group R-4 Condition 1.

G. Add Sections 903.2.8.3, 903.2.8.3.1, 903.2.8.3.2, and 903.2.8.4 to the IBC to read:

903.2.8.3 Group R-4 Condition 2. An automatic sprinkler system installed in accordance with Section 903.3.1.2 shall be permitted in Group R-4 Condition 2. Attics shall be protected in accordance with Section 903.2.8.3.1 or 903.2.8.3.2.

903.2.8.3.1 Attics used for living purposes, storage, or fuel fired equipment. Attics used for living purposes, storage, or fuel fired equipment shall be protected throughout with automatic sprinkler system installed in accordance with Section 903.3.1.2.

903.2.8.3.2 Attics not used for living purposes, storage, or fuel fired equipment. Attics not used for living purposes, storage, or fuel fired equipment shall be protected in accordance with one of the following:

1. Attics protected throughout by a heat detector system arranged to activate the building fire alarm system in accordance with Section 907.2.10.

2. Attics constructed of noncombustible materials.

3. Attics constructed of fire-retardant-treated wood framing complying with Section 2303.2.

4. The automatic fire sprinkler system shall be extended to provide protection throughout the attic space.

903.2.8.4 Care facilities. An automatic sprinkler system installed in accordance with 903.3.1.3 shall be permitted in care facilities with 5 or fewer individuals in a single-family dwelling.

~~H. Add Item 6 to Section 903.3.1.1.1 of the IBC to read:~~

~~6. Elevator machine rooms and elevator machine spaces for occupant evacuation elevators.~~

~~I. H. Add Section 903.3.1.2.2 to the IBC to read:~~

903.3.1.2.2 Attics. Sprinkler protection shall be provided for attics in buildings of Type III, IV or V construction in Group R-2 occupancies that are designed or developed and marketed to senior citizens 55 years of age or older and in Group I-1 occupancies in accordance with Section 6.7.2 of NFPA 13R.

I. Change Section 903.3.1.3 of the IBC to read:

903.3.1.3 NFPA 13D sprinkler systems. Automatic sprinkler systems installed in one-family and two-family dwellings, Group R-3, Group R-4 Condition 1 and townhouses shall be permitted to be installed throughout in accordance with NFPA 13D.

J. Change Section 903.4.2 of the IBC to read:

903.4.2 Alarms. Approved audible devices shall be connected to every automatic sprinkler system. Such sprinkler water-flow alarm devices shall be activated by water flow equivalent to the flow of a single sprinkler of the smallest orifice size installed in the system. Alarm devices shall be provided on the exterior of the building in an approved location. Where a fire alarm system is installed, actuation of the automatic sprinkler system shall actuate the building fire alarm system. Group R-2 occupancies that contain 16 or more dwelling units or sleeping units, any dwelling unit or sleeping unit two or more stories above the lowest level of exit discharge, or any dwelling unit or sleeping unit more than one story below the highest level of exit discharge of exits serving the dwelling unit or sleeping unit shall provide a manual fire alarm box at an approved location to activate the suppression system alarm.

K. Add an exception to Section 905.2 of the IBC to read:

Exception: The residual pressure of 100 psi for 2-1/2 inch hose connection and 65 psi for 1-1/2 inch hose connection is not required in buildings equipped throughout with an automatic sprinkler system in accordance with Section 903.3.1.1 or 903.3.1.2 and where the highest floor level is not more than 150 feet above the lowest level of fire department vehicle access.

L. Change Item 1 of Section 906.1 of the IBC to read:

1. In ~~Group~~ Groups A, B, E, F, H, I, M, R-1, R-4, and S occupancies.

Exceptions:

1. In ~~Group~~ Groups A, B, and E occupancies equipped throughout with quick response sprinklers, portable fire extinguishers shall be required only in locations specified in Items 2 through 6.

2. In Group I-3 occupancies, portable fire extinguishers shall be permitted to be located at staff locations and the access to such extinguishers shall be permitted to be locked.

M. Change Section 907.2.1.1 of the IBC to read:

Regulations

907.2.1.1 System initiation in Group A occupancies with a occupant load of 1,000 or more and in certain night clubs. Activation of the fire alarm in Group A occupancies with an occupant load of 1,000 or more and in night clubs with an occupant load of 300 or more shall initiate a signal using an emergency voice and alarm communications system in accordance with Section 907.5.2.2.

Exception: Where approved, the prerecorded announcement is allowed to be manually deactivated for a period of time, not to exceed three minutes, for the sole purpose of allowing a live voice announcement from an approved, constantly attended location.

N. Change Section 907.2.3 of the IBC to read:

907.2.3 Group E. A manual fire alarm system that activates the occupant notification system meeting the requirements of Section 907.5 and installed in accordance with Section 907.6 shall be installed in Group E occupancies. When automatic sprinkler systems or smoke detectors are installed, such systems or detectors shall be connected to the building fire alarm system.

Exceptions:

1. A manual fire alarm system is not required in Group E occupancies with an occupant load of 50 or less.

2. Manual fire alarm boxes are not required in Group E occupancies where all of the following apply:

2.1. Interior corridors are protected by smoke detectors.

2.2. Auditoriums, cafeterias, gymnasiums, and similar areas are protected by heat detectors or other approved detection devices.

2.3. Shops and laboratories involving dusts or vapors are protected by heat detectors or other approved detection devices.

3. Manual fire alarm boxes shall not be required in Group E occupancies where the building is equipped throughout with an approved automatic sprinkler system installed in accordance with Section 903.3.1.1, the occupant notification system will activate on sprinkler water flow and manual activation is provided from a normally occupied location.

O. Change Section 907.2.6.1 of the IBC to read:

907.2.6.1 Group I-1. In Group I-1 occupancies, an automatic smoke detection system shall be installed in corridors, waiting areas open to corridors, and habitable spaces other than sleeping units and kitchens. The system shall be activated in accordance with Section 907.5.

Exceptions:

1. For Group I-1 Condition 1, smoke detection in habitable spaces is not required where the facility is equipped throughout with an automatic sprinkler system in accordance with Section 903.3.1.1.

2. Smoke detection is not required for exterior balconies.

P. Add an exception to Section 907.5.2.1.1 of the IBC to read:

Exception: Sound pressure levels in Group I-3 occupancies shall be permitted to be limited to only the notification of occupants in the affected smoke compartment.

~~Q. Add Sections 908.7, 908.7.1 and 908.7.2 to the IBC to read:~~

~~908.7 Carbon monoxide alarms. Carbon monoxide alarms shall be provided in new buildings and structures in accordance with this section.~~

~~908.7.1 Alarm requirements. Carbon monoxide alarms shall be single station, hard wired, plug in or battery type, listed as complying with UL 2034, and shall be installed in accordance with this code and the manufacturer's installation instructions.~~

~~908.7.2 Where required. Carbon monoxide alarms shall be installed outside of each separate sleeping area in the immediate vicinity of the bedrooms in dwelling units and outside of, but in the immediate vicinity of, each sleeping unit in all Group R occupancies located within buildings containing fuel fired appliances or where a dwelling unit or sleeping unit in a Group R occupancy is attached to a Group U private garage.~~

~~P. Q. Change Section 909.6 of the IBC to read:~~

~~909.6 Pressurization method. When approved by the building official, the means of controlling smoke shall be permitted by pressure differences across smoke barriers. Maintenance of a tenable environment is not required in the smoke-control zone of fire origin.~~

~~Q. R. Change Section 911.1.3 of the IBC to read:~~

~~911.1.3 Size. The fire command center shall be a minimum of 96 square feet (9 m²) in area with a minimum dimension of eight feet (2438 mm).~~

~~Exception: Where it is determined by the building official, after consultation with the fire chief, that specific building characteristics require a larger fire command center, the building official may increase the minimum required size of the fire command center up to 200 square feet (19 m²) in area with a minimum dimension of up to 10 feet (3048 mm).~~

~~R. S. Change the title of IBC Section 915 to read:~~

~~In-Building Emergency Communications Coverage.~~

~~S. T. Change Section 915.1 of the IBC to read:~~

~~915.1 General. For localities utilizing public safety wireless communications, dedicated infrastructure to accommodate and perpetuate continuous in-building emergency communication equipment to allow emergency public safety personnel to send and receive emergency communications shall be provided in new buildings and structures in accordance with this section.~~

Exceptions:

1. Buildings of Use Groups A-5, I-4, within dwelling units of R-2, R-3, R-4, R-5, and U.
2. Buildings of ~~Type~~ Types IV and V construction without basements, that are not considered unlimited area buildings in accordance with Section 507.
3. Above grade single story buildings of less than 20,000 square feet.
4. Buildings or leased spaces occupied by federal, state, or local governments, or the contractors thereof, with security requirements where the building official has approved an alternative method to provide emergency communication equipment for emergency public safety personnel.
5. Where the owner provides technological documentation from a qualified individual that the structure or portion thereof does not impede emergency communication signals.

~~F.~~ U. Add Sections 915.1.1, 915.1.2 and 915.1.3 to the IBC to read:

915.1.1 Installation. The building owner shall install radiating cable, such as coaxial cable or equivalent. The radiating cable shall be installed in dedicated conduits, raceways, plenums, attics, or roofs, compatible for these specific installations as well as other applicable provisions of this code. The locality shall be responsible for the installation of any additional communication equipment required for the operation of the system.

915.1.2 Operations. The locality will assume all responsibilities for the operation and maintenance of the emergency communication equipment. The building owner shall provide sufficient operational space within the building to allow the locality access to and the ability to operate in-building emergency communication equipment.

915.1.3 Inspection. In accordance with Section 113.3, all installations shall be inspected prior to concealment.

~~U.~~ V. Add Section 915.2 to the IBC to read:

915.2 Acceptance test. Upon completion of installation, after providing reasonable notice to the owner or their representative, emergency public safety personnel shall have the right during normal business hours, or other mutually agreed upon time, to enter onto the property to conduct field tests to verify that the required level of radio coverage is present at no cost to the owner. Any noted deficiencies in the installation of the radiating cable or operational space shall be provided in an inspection report to the owner or the owner's representative.

13VAC5-63-245. Chapter 10 Means of egress.

A. Delete Section 1001.4 of the IBC.

B. Change Section 1004.3 of the IBC to read:

1004.3 Posting of occupant load. Every room or space that is an assembly occupancy and where the occupant load of

that room or space is 50 or more shall have the occupant load of the room or space posted in a conspicuous place, near the main exit or exit access doorway from the room or space. Posted signs shall be of an approved legible permanent design and shall be maintained by the owner or authorized agent.

~~B.~~ C. Change the exception to Section 1005.1 1005.3.1 of the IBC to read:

~~1005.1 Minimum required egress width. The means of egress width shall not be less than required by this section. The total width of means of egress in inches (mm) shall not be less than the total occupant load served by the means of egress multiplied by 0.3 inches (7.62 mm) per occupant for stairways and by 0.2 inches (5.08 mm) per occupant for other egress components. The width shall not be less than specified elsewhere in this code. Multiple means of egress shall be sized such that the loss of any one means of egress shall not reduce the available capacity to less than 50% of the required capacity. The maximum capacity required from any story of a building shall be maintained to the termination of the means of egress.~~

Exceptions Exception:

1. Means of egress complying with Section 1028.

2. For occupancies other than Groups H-1, H-2, H-3, H-4 Groups H and I-2 occupancies, the capacity, in inches (mm), of means of egress stairways shall be calculated by multiplying the occupant load served by such stairway by a means of egress capacity factor of 0.2 inch (5.1 mm) per occupant in buildings equipped with an automatic sprinkler system installed in accordance with Section 903.3.1.1 or 903.3.1.2, the total width of means of egress in inches (mm) shall not be less than the total occupant load served by the means of egress multiplied by 0.2 inches (5.08 mm) per occupant for stairways and by 0.15 inches (3.81 mm) per occupant for other egress components.

~~C.~~ D. Change the exception to Section 1007.2 1005.3.2 of the IBC to read:

~~1007.2 Continuity and components. Each required accessible means of egress shall be continuous to a public way and shall consist of one or more of the following components:~~

1. Accessible routes complying with Section 1104.

2. Interior exit stairways complying with Sections 1007.3 and 1022.

3. Exterior exit stairways complying with Sections 1007.3 and 1026 and serving levels other than the level of exit discharge.

4. Elevators complying with Section 1007.4.

5. Platform lifts complying with Section 1007.5.

6. Horizontal exits complying with Section 1025.

7. Ramps complying with Section 1010.

8. Areas of refuge complying with Section 1007.6.

Regulations

~~9. Exterior area for assisted rescue complying with Section 1007.7 serving exits at the level of exit discharge.~~

~~Exception: For other than Groups H and I-2 occupancies, the capacity, in inches (mm), of means of egress components other than stairways shall be calculated by multiplying the occupant load served by such stairway by a means of egress capacity factor of 0.15 inch (3.8 mm) per occupant in buildings equipped with an automatic sprinkler system installed in accordance with Section 903.3.1.1 or 903.3.1.2.~~

~~D. E.~~ Change Section 1007.6.2 of the IBC to read:

1007.6.2 Separation. Each area of refuge shall be separated from the remainder of the story by a smoke barrier complying with Section 709 or a horizontal exit complying with Section 1025. Each area of refuge shall be designed to minimize the intrusion of smoke.

Exceptions:

1. Areas of refuge located within an exit enclosure.
2. Areas of refuge where the area of refuge and areas served by the area of refuge are equipped throughout with an automatic sprinkler system installed in accordance with Section 903.3.1.1 or 903.3.1.2.

~~E.~~ Change Section 1007.7, including subsections, of the IBC to read:

~~1007.7 Exterior area for assisted rescue. The exterior area for assisted rescue shall be an area provided on the exterior landing serving an exit door on an accessible route. The exterior area of assisted rescue shall meet the size and access requirements of Section 1007.6.1.~~

~~1007.7.1 Separation. Exterior walls separating the exterior area of assisted rescue from the interior of the building shall have a minimum fire resistance rating of one hour, rated for exposure to fire from the inside. The fire resistance rated exterior wall construction shall extend horizontally 10 feet (3048 mm) beyond the landing on either side of the landing or equivalent fire resistance rated construction is permitted to extend out perpendicular to the exterior wall four feet (1220 mm) minimum on the side of the landing. The fire resistance rated construction shall extend vertically from the ground to a point 10 feet (3048 mm) above the floor level of the area for assisted rescue or to the roof line, whichever is lower. Openings within such fire resistance rated exterior walls shall be protected in accordance with Section 715.~~

~~1007.7.2 Openness. The exterior area for assisted rescue shall be at least 50% open, and the open area above the guards shall be so distributed as to minimize the accumulation of smoke or toxic gases.~~

~~1007.7.3 Exterior stairway. Exterior stairways that are part of the means of egress for the exterior area for assisted rescue shall provide a clear width of 48 inches (1219 mm) between handrails.~~

F. Change Item 2 of Section 1008.1.9.3 of the IBC to read:

2. In buildings in occupancy Groups B, F, M and S, the main exterior door or doors are permitted to be equipped with key-operated locking devices from the egress side provided:

2.1. The locking device is readily distinguishable as locked.

2.2. A readily visible durable sign is posted on the egress side on or adjacent to the door stating: THIS DOOR TO REMAIN UNLOCKED WHEN BUILDING IS OCCUPIED. The sign shall be in letters one inch (25 mm) high on a contrasting background.

2.3. The use of the key-operated locking device is revokable by the building official for due cause.

G. Delete Section 1008.1.9.6 of the IBC.

H. Change Section 1008.1.9.7 of the IBC to read:

1008.1.9.7 Delayed egress locks. Approved, listed, delayed egress locks shall be permitted to be installed on doors serving any occupancy including Group A-3, airport facilities, except Group A, E and H occupancies in buildings which are equipped throughout with an automatic sprinkler system in accordance with Section 903.3.1.1 or an approved automatic smoke or heat detection system installed in accordance with Section 907, provided that the doors unlock in accordance with Items 1 through 6 below. A building occupant shall not be required to pass through more than one door equipped with a delayed egress lock before entering an exit.

1. The doors unlock upon actuation of the automatic sprinkler system or automatic fire detection system.

2. The doors unlock upon loss of power controlling the lock or lock mechanism.

3. The door locks shall have the capability of being unlocked by a signal from the fire command center.

4. The initiation of an irreversible process which will release the latch in not more than 15 seconds when a force of not more than 15 pounds (67 N) is applied for 1 second to the release device. Initiation of the irreversible process shall activate an audible signal in the vicinity of the door. Once the door lock has been released by the application of force to the releasing device, relocking shall be by manual means only.

Exception: Where approved, a delay of not more than 30 seconds is permitted.

5. A sign shall be provided on the door located above and within 12 inches (305 mm) of the release device reading: PUSH UNTIL ALARM SOUNDS. DOOR CAN BE OPENED IN 15 SECONDS.

Exception: Where approved, such sign shall read: PUSH UNTIL ALARM SOUNDS. DOOR CAN BE OPENED IN 30 SECONDS.

6. Emergency lighting shall be provided at the door.

I. Delete the exception in Section 1008.1.10 of the IBC.

J. Add Section 1008.1.11 to the IBC to read:

1008.1.11 Locking certain residential sliding doors. In dwelling units of Group R-2 buildings, exterior sliding doors which are one story or less above grade, or shared by two dwelling units, or are otherwise accessible from the outside, shall be equipped with locks. The mounting screws for the lock case shall be inaccessible from the outside. The lock bolt shall engage the strike in a manner that will prevent it from being disengaged by movement of the door.

Exception: Exterior sliding doors which are equipped with removable metal pins or charlie bars.

K. Add Section 1008.1.12 to the IBC to read:

1008.1.12 Door viewers in certain residential buildings. Entrance doors to dwelling units of Group R-2 buildings shall be equipped with door viewers with a field of vision of not less than 180 degrees.

Exception: Entrance doors having a vision panel or side vision panels.

L. Change Exception 5 of Section ~~1009.4.2~~ 1009.7.2 of the IBC to read:

5. In Group R-3 occupancies; within dwelling units in Group R-2 occupancies; and in Group U occupancies that are accessory to a Group R-3 occupancy or accessory to individual dwelling units in Group R-2 occupancies; the maximum riser height shall be 8.25 inches (210 mm); the minimum tread depth shall be 9 inches (229 mm); the minimum winder tread depth at the walk line shall be 10 inches (254 mm); and the minimum winder tread depth shall be 6 inches (152 mm). A nosing not less than 0.75 inch (19.1 mm) but not more than 1.25 inches (32 mm) shall be provided on stairways with solid risers where the tread depth is less than 11 inches (279 mm).

M. Add ~~Exception 3 to~~ Change Section ~~1009.7~~ 1013.8 of the IBC to read:

~~3. Spiral stairways used as a means of egress from technical production areas. 1013.8 Window sills. In Occupancy Groups R-2 and R-3, one-family and two-family and multiple-family dwellings, where the opening of the sill portion of an operable window is located more than 72 inches (1829 mm) above the finished grade or other surface below, the lowest part of the clear opening of the window shall be at a height not less than 18 inches (457 mm) above the finished floor surface of the room in which the window is located. Operable sections of windows shall not permit openings that allow passage of a 4-inch-diameter (102 mm) sphere where such openings are located within 18 inches (457 mm) of the finished floor.~~

Exceptions:

1. Operable windows where the sill portion of the opening is located more than 75 feet (22 860 mm) above

the finished grade or other surface below and that are provided with window fall prevention devices that comply with ASTM F 2006.

2. Windows whose openings will not allow a 4-inch diameter (102 mm) sphere to pass through the opening when the window is in its largest opened position.

3. Openings that are provided with window fall prevention devices that comply with ASTM F 2090.

4. Windows that are provided with window opening control devices that comply with Section 1013.8.1.

N. Add Exception 3 to Item 4 of Section 1014.2 of the IBC to read:

3. A maximum of one exit access is permitted to pass through kitchens, store rooms, closets or spaces used for similar purposes provided such a space is not the only means of exit access.

O. Change Exception 1 in Item 1 of Section 1015.1 of the IBC to read:

1. In Groups R-2 and R-3 occupancies, one means of egress is permitted within and from individual dwelling units with a maximum occupant load of 20 where the dwelling unit is equipped throughout with an automatic sprinkler system in accordance with Section 903.3.1.1 or 903.3.1.2. This exception shall also apply to Group R-2 occupancies where Section 903.2.8, Exception 1 or 2 is applicable.

P. Change Table 1015.1 of the IBC to read:

Table 1015.1 Spaces With One Exit or Exit Access Doorway	
Occupancy	Maximum Occupant Load
A, B, E ^a , F, M, U	50
H-1, H-2, H-3	3
H-4, H-5, I-1, I-3, I-4, R	10
S	29
a. Day care maximum occupant load is 10.	

~~P. Q.~~ Change Exception 2 of Section 1015.2.1 of the IBC to read:

2. Where a building is equipped throughout with an automatic sprinkler system in accordance with Section 903.3.1.1 or 903.3.1.2, the separation distance of the exit doors or exit access doorways shall not be less than one-fourth of the length of the maximum overall diagonal dimension of the area served.

~~Q. Delete Sections 1015.6 and 1015.6.1 of the IBC.~~

R. Change Exception 2 of Section 1018.1 of the IBC to read:

2. A fire-resistance rating is not required for corridors contained within a dwelling or sleeping unit in an occupancy in Group I-1 and Group R.

Regulations

S. Change Table 1018.1 of the IBC to read:

Table 1018.1 Corridor Fire-Resistance Rating			
Occupancy	Occupant Load Served By Corridor	Required Fire-Resistance Rating (hours)	
		Without sprinkler system	With sprinkler system ^b
H-1, H-2, H-3	All	Not Permitted	1
H-4, H-5	Greater than 30	Not Permitted	1
A, B, E, F, M, S, U	Greater than 30	1	0
R	Greater than 10	1	0.5
I-2 ^a , I-4	All	Not Permitted	0
I-1, I-3	All	Not Permitted	0

a. For requirements for occupancies in Group I-2, see Sections 407.2 and 407.3.

b. Buildings equipped throughout with an automatic sprinkler system in accordance with ~~Sections~~ Section 903.3.1.1 or 903.3.1.2 where allowed.

S. T. Add ~~Exception 7~~ to ~~Section~~ an additional row to Table 1018.2 of the IBC to read:

~~7. Forty-four inches (1118 mm) — In corridors of Group I-2 assisted living facilities serving areas with wheelchair, walker and gurney traffic where residents are capable of self-preservation or where resident rooms have a means of egress door leading directly to the outside.~~

Occupancy	Width (minimum)
<u>In corridors of Group I-2 assisted living facilities licensed by the Virginia Department of Social Services serving areas with wheelchair, walker, and gurney traffic where residents are capable of self-preservation or where resident rooms have a means of egress, door leading directly to the outside.</u>	<u>44 inches</u>

T. U. Change the first row in Table ~~1021.2~~ 1021.2(2) to read:

Table 1021.2 Table 1021.2(2) Stories With One Exit			
Story	Occupancy	Maximum Occupants (or Dwelling Units) Per Floor and Travel Distance	
First story or basement	A, B ^d , E ^e , F ^d , M, U, S ^d	50 occupants and 75 feet travel distance	
	H 2, H 3	3 occupants and 25 feet travel distance	
	H 4, H 5, I, R	10 occupants and 75 feet travel distance	
	S ^a	29 occupants and 100 feet travel distance	
Second story	B ^b , F, M, S ^a	29 occupants and 75 feet travel distance	
	R-2	4 dwelling units and 50 feet travel distance	
Third story	R-2 ^e	4 dwelling units and 50 feet travel distance	

For SI: 1 foot = 304.8 mm

a. For the required number of exits for parking structures, see Section 1021.1.2.

b. For the required number of exits for air traffic control towers, see Section 412.3.

e. Buildings classified as Group R-2 equipped throughout with an automatic sprinkler system in accordance with Section 903.3.1.1 or 903.3.1.2 and provided with emergency escape and rescue openings in accordance with Section 1029.

d. Group B, F and S occupancies in buildings equipped throughout with an automatic sprinkler system in accordance with Section 903.3.1.1 shall have a maximum travel distance of 100 feet.

e. Day care occupancies shall have a maximum occupant load of 10.

Story	Occupancy	Maximum Occupants per Story	Maximum Exit Access

			<u>Travel Distance</u>
<u>First story or basement</u>	<u>A, B^b, E, F^b, M, U, S^b</u>	<u>50 occupants</u>	<u>75 feet</u>

an accessible route provided such areas are used exclusively for the performance of religious ceremonies and are located within an accessible story or mezzanine.

C. Change Section 1106.1 of the IBC and replace Table 1106.1 of the IBC with Tables 1106.1(1) and 1106.1(2) to read:

U. ~~Change Exception 6 of Section 1022.1 of the IBC to read:~~

~~6. Means of egress stairways as provided for in Section 410.6.2 are not required to be enclosed.~~

V. Change Section 1022.8 1022.9 of the IBC to read:

1022.8 1022.9 Floor identification signs. A sign shall be provided at each floor landing in exit enclosures connecting more than three stories designating the floor level, the terminus of the top and bottom of the exit enclosure and the identification of the stair or ramp by designation with a letter of the alphabet. The signage shall also state the story of, and the direction to, the exit discharge and the availability of roof access from the enclosure for the fire department. The sign shall be located five feet (1524 mm) above the floor landing in a position that is readily visible when the doors are in the open and closed positions. Floor level identification signs in tactile characters complying with ICC A117.1 shall be located at each floor level landing adjacent to the door leading from the enclosure into the corridor to identify the floor level.

W. Change Section 1024.1 of the IBC to read:

1024.1 General. Approved luminous egress path markings delineating the exit path shall be provided in buildings of Groups A, B, E, I, M and R-1 having occupied floors located more than 420 feet (128 016 mm) above the lowest level of fire department vehicle access in accordance with Sections 1024.1 through 1024.5.

~~Exceptions 1.~~ Exception: Luminous egress path markings shall not be required on the level of exit discharge in lobbies that serve as part of the exit path in accordance with Section 1027.1, Exception 1.

~~2. Luminous egress path markings shall not be required in areas of open parking garages that serve as part of the exit path in accordance with Section 1027.1, Exception 3.~~

13VAC5-63-250. Chapter 11 Accessibility.

A. Add an exception to Section 1101.2 of the IBC to read:

Exception: Wall-mounted visible alarm notification appliances in Group I-3 occupancies shall be permitted to be a maximum of 120 inches (3048 mm) above the floor or ground, measured to the bottom of the appliance. Such appliances shall otherwise comply with all applicable requirements.

B. Add Section 1103.2.16 to the IBC to read:

1103.2.16 Raised and lowered areas in places of religious worship. Raised or lowered areas in places of religious worship are not required to be accessible or to be served by

1106.1 Required. Where parking is provided, accessible parking spaces shall be provided in compliance with Tables 1106.1(1) and 1106.1(2), as applicable, except as required by Sections 1106.2 through 1106.4. Where more than one parking facility is provided on a site, the number of parking spaces required to be accessible shall be calculated separately for each parking facility.

Exception: This section does not apply to parking spaces used exclusively for buses, trucks, other delivery vehicles, law-enforcement vehicles, or vehicular impound and motor pools where lots accessed by the public are provided with an accessible passenger loading zone.

<u>Table 1106.1(1)</u> <u>Accessible Parking Spaces for Groups A, B, E, M, R-1, R-2, and I^a</u>	
<u>Total Parking Spaces Provided</u>	<u>Required Minimum Number of Accessible Spaces</u>
<u>1 - 25</u>	<u>1</u>
<u>26 - 50</u>	<u>2</u>
<u>51 - 75</u>	<u>3</u>
<u>76 - 100</u>	<u>4</u>
<u>101 - 125</u>	<u>5</u>
<u>126 - 150</u>	<u>6</u>
<u>151 - 200</u>	<u>7</u>
<u>201 - 300</u>	<u>8</u>
<u>301 - 400</u>	<u>9</u>
<u>401 - 500</u>	<u>10</u>
<u>501 - 1,000</u>	<u>2.33% of total</u>
<u>1,001 and over</u>	<u>23, plus one for each 100, or fraction thereof, over 1,000</u>
<u>a. Condominium parking in Group R-2 occupancies where parking is part of the unit purchase shall be in accordance with Table 1106.1(2).</u>	

Regulations

<u>Table 1106.1(2)</u> <u>Accessible Parking Spaces for Groups F, S, H, R-3, R-4, and U</u>	
<u>Total Parking Spaces Provided</u>	<u>Required Minimum Number of Accessible Spaces</u>
<u>1 - 25</u>	<u>1</u>
<u>26 - 50</u>	<u>2</u>
<u>51 - 75</u>	<u>3</u>
<u>76 - 100</u>	<u>4</u>
<u>101 - 150</u>	<u>5</u>
<u>151 - 200</u>	<u>6</u>
<u>201 - 300</u>	<u>7</u>
<u>301 - 400</u>	<u>8</u>
<u>401 - 500</u>	<u>9</u>
<u>501 - 1,000</u>	<u>2.0% of total</u>
<u>1,001 and over</u>	<u>20, plus one for each 100, or fraction thereof, over 1,000</u>

D. Add Section 1106.8 to the IBC to read:

1106.8 Identification of accessible parking spaces. In addition to complying with applicable provisions of this chapter, all accessible parking spaces shall be identified by above grade signs. A sign or symbol painted or otherwise displayed on the pavement of a parking space shall not constitute an above grade sign. All above grade parking space signs shall have the bottom edge of the sign no lower than four feet (1219 mm) nor higher than seven feet (2133 mm) above the parking surface. All disabled parking signs shall include the following language: PENALTY, \$100-500 Fine, TOW-AWAY ZONE. Such language may be placed on a separate sign and attached below existing above grade disabled parking signs, provided that the bottom edge of the attached sign is no lower than four feet above the parking surface.

~~D.~~ E. Add Sections 1109.16 and 1109.16.1 to the IBC to read:

1109.16 Dwellings containing universal design features for accessibility. Group R-5 occupancies not subject to Section R320.1 of the IRC and Group R-3 occupancies not subject to Section 1107.6.3 may comply with this section and be approved by the local building department as dwellings containing universal design features for accessibility.

1109.16.1 Standards for dwellings containing universal design features for accessibility. When the following requirements are met, approval shall be issued by the local

building department indicating that a dwelling has been constructed in accordance with these standards and is deemed to be a dwelling containing universal design features for accessibility.

1. The dwelling must comply with the requirements for Type C units under Section 1005 of ICC A117.1 with the following changes to the those requirements:

1.1. That at least one bedroom be added to the interior spaces required by Section 1005.4 of ICC A117.1.

1.2. In the toilet room or bathroom required by Section 1005 of ICC A117.1, in addition to the lavatory and water closet, a shower or bathtub complying with Section 1004.11.3.2.3 of ICC A117.1 shall be provided and shall include reinforcement for future installation of grab bars in accordance with Section 1004.11.1 of ICC A117.1.

1.3. That the exception to Section 1005.4 of ICC A117.1 is not applicable.

1.4. That there be a food preparation area complying with Section 1005.7 of ICC A117.1 on the entrance level.

1.5. That any thermostat for heating or cooling on the entrance level comply with Section 1005.8 of ICC A117.1.

F. Change Item 1 of Section 1110.1 of the IBC to read:

1. Accessible parking spaces required by Section 1106.1.

13VAC5-63-260. Chapter 12 Interior environment.

A. Add the following definitions to the list of terms in Section 1202.1 of the IBC:

~~Day-night average sound level (Ldn). A 24 hour energy average sound level expressed in dBA, with a 10 decibel penalty applied to noise occurring between 10 p.m. and 7 a.m.~~

~~Sound transmission class (STC) rating. A single number characterizing the sound reduction performance of a material tested in accordance with ASTM E90 90, "Laboratory Measurement of Airborne Sound Transmission Loss of Building Partitions."~~

B. Add Section 1203.4.4 to the IBC to read:

1203.4.4 Insect screens in occupancies other than Group R. Every door, window and other outside opening for natural ventilation serving structures classified as other than a residential group containing habitable rooms, food preparation areas, food service areas, or any areas where products to be included or utilized in food for human consumption are processed, manufactured, packaged, or stored, shall be supplied with approved tightly fitting screens of not less than 16 mesh per inch (16 mesh per 25 mm) and every screen door used for insect control shall have a self-closing device.

Exception: Screen doors shall not be required for out swinging doors or other types of openings which make screening impractical, provided other approved means, such as air curtains or insect repellent fans are provided.

C. Add Section 1203.4.5 to the IBC to read:

1203.4.5 Insect screens in Group R occupancies. Every door, window and other outside opening required for natural ventilation purposes which serves a structure classified as a residential group shall be supplied with approved tightly fitted screens of not less than 16 mesh per inch (16 mesh per 25 mm) and every screen door used for insect control shall have a self-closing device.

D. Change Section 1207.1 of the IBC to read:

1207.1 Scope. Sections 1207.2 and 1207.3 shall apply to common interior walls, partitions and floor/ceiling assemblies between adjacent dwelling units or between dwelling units and adjacent public areas such as halls, corridors, stairs or service areas. Section 1207.4 applies to the construction of the exterior envelope of Group R occupancies within airport noise zones and to the exterior envelope of Group A, B, E, I and M occupancies in any locality in whose jurisdiction, or adjacent jurisdiction, is located a United States Master Jet Base, a licensed airport or United States government or military air facility, when such requirements are enforced by a locality pursuant to § 15.2-2295 of the Code of Virginia.

E. Add Section 1207.4 to the IBC to read:

1207.4 Airport noise attenuation standards. Where the Ldn is determined to be 65 dBA or greater, the minimum STC rating of structure components shall be provided in compliance with Table 1207.4. As an alternative to compliance with Table 1207.4, structures shall be permitted to be designed and constructed so as to limit the interior noise level to no greater than 45 Ldn. Exterior structures, terrain and permanent plantings shall be permitted to be included as part of the alternative design. The alternative design shall be certified by an RDP.

F. Add Table 1207.4 to the IBC to read:

Table 1207.4. Airport Noise Attenuation Standards.		
Ldn	STC of exterior walls and roof/ceiling assemblies	STC of doors and windows
65-69	39	25
70-74	44	33
75 or greater	49	38

13VAC5-63-264. Chapter 13 Energy efficiency.

Add Section 1301.1.1.1 to the IBC to read:

1301.1.1.1 Changes to the ~~International Energy Conservation Code (IECC)~~ IECC. The following change changes shall be made to the IECC:

1. Add Exception 3 to Section C402.4.5.2 to read:

3. Any grease duct serving a Type I hood installed in accordance with IMC Section 506.3 shall not be required to have a motorized or gravity damper.

2. Change Section C402.4.8 to read:

C402.4.8 Recessed lighting. Recessed luminaires installed in the building thermal envelope shall be sealed to limit air leakage between conditioned and unconditioned spaces. All recessed luminaires shall be IC-rated and labeled as having an air leakage rate or not more 2.0 cfm (0.944 L/s) when tested in accordance with ASTM E 283 at a 1.57 psf (75 Pa) pressure differential. All recessed luminaires installed in the thermal envelope shall be sealed with a gasket or caulk between the housing and interior wall or ceiling covering.

3. Add Exception 4 to Section C403.2.4.4 to read:

4. Any grease duct serving a Type I hood installed in accordance with IMC Section 506.3 shall not be required to have a motorized or gravity damper.

4. Change the exception to Section C405.1 to read:

Exception: Dwelling units within commercial buildings shall not be required to comply with Sections C405.2 through C405.5, provided that not less than 75% of the permanently installed luminaires, other than low-voltage lighting, shall be fitted for, and contain only, high-efficacy lamps.

5. Change Section C405.6 to read:

C405.6 Exterior lighting (Mandatory). All exterior lighting, other than low-voltage landscape lighting, shall comply with Sections C405.6.1 and C405.6.2.

Exception: Where approved because of historical, safety, signage, or emergency considerations.

6. Delete Section ~~401.3~~ R401.3.

7. Change the ceiling R-value and wood frame wall R-value categories for climate zone "4 except Marine" in Table R402.1.1 to read:

Ceiling R-Value	Wood Frame Wall R-Value
38	15 or 13 + 1 ^h

8. Change the ceiling U-factor and frame wall U-factor categories for climate zone "4 except Marine" in Table R402.1.3 to read:

Ceiling U-Factor	Frame Wall U-Factor
0.030	0.079

9. Change Sections R402.2.1 and R402.2.4 to read:

R402.2.1 Ceilings with attic spaces. When Section R402.1.1 would require R-38 in the ceiling, installing R-30 over 100% of the ceiling area shall be deemed to satisfy the requirement for R-38 wherever the full height of uncompressed R-30 insulation extends over the wall top plate at the eaves. Similarly, when Section R402.1.1

Regulations

would require R-49 in the ceiling, installing R-38 over 100% of the ceiling area shall be deemed to satisfy the requirement for R-49 wherever the full height of uncompressed R-38 insulation extends over the wall top plate at the eaves. This reduction shall not apply to the U-factor alternative approach in Section R402.1.3 and the total UA alternative in Section R402.1.4.

R402.2.4 Access hatches and doors. Access doors from conditioned spaces to unconditioned spaces (e.g., attics and crawl spaces) shall be weatherstripped and insulated in accordance with the following values:

1. Hinged vertical doors shall have a minimum overall R-5 insulation value;
2. Hatches and scuttle hole covers shall be insulated to a level equivalent to the insulation on the surrounding surfaces; and
3. Pull down stairs shall have a minimum of 75% of the panel area having R-5 rigid insulation.

Access shall be provided to all equipment that prevents damaging or compressing the insulation. A wood framed or equivalent baffle or retainer is required to be provided when loose fill insulation is installed, the purpose of which is to prevent the loose fill insulation from spilling into the living space when the attic access is opened and to provide a permanent means of maintaining the installed R-value of the loose fill insulation.

10. Delete Section R402.3.6 and change Sections R402.4 and R402.4.1.1 to read:

R402.4 Air leakage. The building thermal envelope shall be constructed to limit air leakage in accordance with the requirements of Sections R402.4.1 through R402.4.4.

R402.4.1.1 Installation (Mandatory). The components of the building thermal envelope as listed in Table R402.4.1.1 shall be installed in accordance with the manufacturer's instructions and the criteria listed in Table R402.4.1.1, as applicable to the method of construction. Where required by the code official, an approved third party shall inspect all components and verify compliance.

11. Change the title of the "Criteria" category of Table R402.4.1.1; change the "Walls," "Shower/tub on exterior wall" and "Fireplace" categories of Table R402.4.1.1, and add footnotes "b" and "c" to Table R402.4.1.1 to read:

Component	Criteria ^{a,b}
Walls	<p><u>Cavities within corners and headers shall be insulated by completely filling the cavity with a material having a minimum thermal resistance of R-3 per inch.</u></p> <p><u>The junction of the foundation and sill plate shall be sealed.</u></p>

The junction of the top plate and top of exterior walls shall be sealed.

Exterior thermal envelope insulation for framed walls shall be installed in substantial contact and continuous alignment with the air barrier. Knee walls shall be sealed.

Shower or tub on exterior wall^c

Exterior walls adjacent to showers and tubs shall be insulated and an air barrier installed on the interior side of the exterior wall, adjacent to the shower or tub.

Fireplace

An air barrier shall be installed on fireplace walls. Fireplaces shall have gasketed doors or tight-fitting flue dampers.

b. Structural integrity of headers shall be in accordance with the applicable building code.

c. Air barriers used behind showers and tubs on exterior walls shall be of a permeable material that does not cause the entrapment of moisture in the stud cavity.

12. Change Section R402.4.1.2 and add Sections R402.4.1.2.1, R402.4.1.2.2, and R402.4.1.3 to read:

R402.4.1.2 Air sealing. Building envelope air tightness shall be demonstrated to comply with either Section R402.4.1.2.1 or R402.4.1.2.2.

R402.4.1.2.1 Testing option. The building or dwelling unit shall be tested for air leakage. Testing shall be conducted with a blower door at a pressure of 0.2 inches w.g. (50 Pascals). Where required by the building official, testing shall be conducted by an approved third party. A written report of the results of the test shall be signed by the party conducting the test and provided to the building official. Testing shall be performed at any time after creation of all penetrations of the building thermal envelope.

During testing:

1. Exterior windows and doors and fireplace and stove doors shall be closed, but not sealed beyond the intended weatherstripping or other infiltration control measures;
2. Dampers, including exhaust, intake, makeup air, backdraft, and flue dampers, shall be closed, but not sealed beyond intended infiltration control measures;
3. Interior doors, if installed at the time of the test, shall be open;
4. Exterior doors for continuous ventilation systems and heat recovery ventilators shall be closed and sealed;

5. Heating and cooling systems, if installed at the time of the test, shall be turned off; and

6. Supply and return registers, if installed at the time of the test, shall be fully open.

R402.4.1.2.2 Visual inspection option. Building envelope tightness shall be considered acceptable when the items listed in Table R402.4.1.1, applicable to the method of construction, are field verified. Where required by the building official, an approved party, independent from the installer, shall inspect the air barrier.

R402.4.1.3 Leakage rate (Prescriptive). The building or dwelling unit shall have an air leakage rate not exceeding 5 changes per hour as verified in accordance with Section R402.4.1.2.

13. Change Section R403.1.1 to read:

R403.1.1 Programmable thermostat. The thermostat controlling the primary heating or cooling system of the dwelling unit shall be capable of controlling the heating and cooling system on a daily schedule to maintain different temperature set points at different times of the day. This thermostat shall include the capability to set back or temporarily operate the system to maintain zone temperatures down to 55°F (13°C) or up to 85°F (29°C). The thermostat shall initially be programmed with a heating temperature set point no higher than 70°F (21°C) and a cooling temperature set point no lower than 78°F (26°C).

2. 14. Change Section ~~403.2.2~~ R403.2.2 to read:

~~403.2.2~~ R403.2.2 Sealing (Mandatory). All ducts, Ducts, air handlers, and filter boxes and building cavities used as ducts shall be sealed. Joints and seams shall comply with Section M1601.4.1 of either the IMC or the International Residential Code IRC, as applicable. Verification of compliance with this section shall be in accordance with either Section ~~403.2.2.1~~ R403.2.2.1 or Section ~~403.2.2.2~~ R403.2.2.2.

Exceptions:

1. Air-impermeable spray foam products shall be permitted to be applied without additional joint seals.
2. Where a duct connection is made that is partially inaccessible, three screws or rivets shall be equally spaced on the exposed portion of the joint so as to prevent a hinge effect.
3. Continuously welded and locking-type longitudinal joints and seams in ducts operating at static pressures less than 2 inches of water column (500 Pa) pressure classification shall not require additional closure systems.

3. 15. Add Change Section ~~403.2.2.1~~ R403.2.2.1 to read:

~~403.2.2.1~~ R403.2.2.1 Testing option. Duct tightness shall be verified by either of the following:

1. Post-construction test: ~~Leakage to outdoors~~ Total leakage shall be less than or equal to 8 6 cfm (3.78 L/s)

~~(169.9 L/min) per 100 ft² square feet (9.29 m²) of conditioned floor area or a total leakage less than or equal to 12 cfm (5.66 L/s) per 100 ft² (9.29m²) of conditioned floor area~~ when tested at a pressure differential of 0.1 inch w.g. (25 Pa) across the entire system, including the manufacturer's air handler ~~and enclosure~~. All register boots shall be taped or otherwise sealed during the test.

2. Rough-in test: Total leakage shall be less than or equal to ~~6 5 cfm (2.83 L/s)~~ (141.5 L/min) per 100 ft² square feet (9.29 m²) of conditioned floor area when tested at a pressure differential of 0.1 inch w.g. (25 Pa) across the ~~roughed-in~~ system, including the manufacturer's air handler enclosure. All register boots shall be taped or otherwise sealed during the test. If the air handler is not installed at the time of the test, total leakage shall be less than or equal to ~~4 5 cfm (1.89 L/s)~~ (141.5 L/min) per 100 ft² square feet (9.29 m²) of conditioned floor area.

Exception: ~~Duct tightness~~ The total leakage test is not required if the for ducts and air handler and all ducts are handlers located entirely within conditioned space the building thermal envelope.

When this option is chosen, testing shall be performed by approved qualified individuals, testing agencies or contractors. Testing and results shall be as prescribed in Section ~~403.2.2~~ R403.2.2 and approved recognized industry standards.

4. 16. Add Section ~~403.2.2.2~~ R403.2.2.2 to read:

~~403.2.2.2~~ R403.2.2.2 Visual inspection option. In addition to the inspection of ducts otherwise required by this code, when the air handler and all ducts are not within conditioned space and this option is chosen to verify duct tightness, duct tightness shall be considered acceptable when the requirements of Section ~~403.2.2~~ R403.2.2 are field verified.

17. Add Section R403.2.2.3 to read:

R403.2.2.3 Sealed air handler. Air handlers shall have a manufacturer's designation for an air leakage of no more than 2.0% of the design air flow rate when tested in accordance with ASHRAE 193.

18. Change Section R403.4.2 to read:

R403.4.2 Hot water pipe insulation (Prescriptive). Insulation for hot water pipe with a minimum thermal resistance (R-value) of R-3 shall be applied to the following:

1. Piping larger than 3/4 inch nominal diameter.
2. Piping serving more than one dwelling unit.
3. Piping located outside the conditioned space.
4. Piping from the water heater to a distribution manifold.
5. Piping located under a floor slab.
6. Buried piping.

Regulations

7. Supply and return piping in recirculation systems other than demand recirculation systems.

19. Delete Table R403.4.2.

20. Change Section R404.1 to read:

R404.1 Lighting equipment (Mandatory). A minimum of 50% of the lamps in permanently installed luminaires shall be high-efficacy lamps or a minimum of 50% of the permanently installed luminaires shall contain only high-efficacy lamps.

Exception: Low-voltage lighting shall not be required to utilize high-efficiency lamps.

21. Change the "Glazing" and "Air exchange rate" categories of Table R405.5.2(1) and add footnote "b-1" to read:

<u>Building Component</u>	<u>Standard Reference Design</u>	<u>Proposed Design</u>
<u>Glazing^a</u>	<u>Total area^b is 15% of the conditioned floor area.</u>	<u>As proposed</u>
<u>Glazing^a</u>	<u>Orientation: equally distributed to four cardinal compass orientations (North, East, South & West).</u>	<u>As proposed</u>
<u>Glazing^a</u>	<u>U-factor: from Table R402.1.3</u>	<u>As proposed</u>
<u>Glazing^a</u>	<u>SHGC: From Table R402.1.1 except that for climates with no requirement (NR) SHGC = 0.40 shall be used.</u>	<u>As proposed</u>
<u>Glazing^a</u>	<u>Interior shade fraction: Summer (all hours when cooling is required) = 0.70 Winter (all hours when heating is required) = 0.85^{b-1}</u>	<u>Same as standard referenced design^{b-1}</u>
<u>Glazing^a</u>	<u>External shading: none.</u>	<u>As proposed</u>
<u>Air exchange rate</u>	<u>Air leakage rate of 5 air changes per hour at a pressure of 0.2 inches w.g (50 Pa). The mechanical ventilation rate shall</u>	<u>For residences that are not tested, the same air leakage rate</u>

be in addition to the air leakage rate and the same as in the proposed design, but no greater than $0.01 \times CFA + 7.5 \times (N_{br} + 1)$ where:

CFA = conditioned floor area

N_{br} = number of bedrooms

Energy recovery shall not be assumed for mechanical ventilation.

as the standard reference design. For tested residences, the measured air exchange rate^c. The mechanical ventilation rate^d shall be in addition to the air leakage rate and shall be as proposed.

b-1. For fenestrations facing within 15 degrees (0.26 rad) of true south that are directly coupled to thermal storage mass, the winter interior shade fraction shall be permitted to be increased to .095 in the proposed design.

13VAC5-63-267. Chapter 14 Exterior walls. (Repealed.)

Change Section 1405.13.2 of the IBC to read:

~~1405.13.2 Window sills. In Occupancy Groups R-2 and R-3, one and two family and multiple family dwellings, where the opening of the sill portion of an operable window is located more than 72 inches (1829 mm) above the finished grade or other surface below, the lowest part of the clear opening of the window shall be at a height not less than 18 inches (457 mm) above the finished floor surface of the room in which the window is located. Glazing between the floor and a height of 18 inches (457 mm) shall be fixed or have openings through which a 4-inch (102 mm) diameter sphere cannot pass.~~

~~Exception: Openings that are provided with window guards that comply with ASTM F2006 or F2090.~~

13VAC5-63-270. Chapter 16 Structural design.

A. Change Section 1609.3 of the IBC to read:

1609.3 Basic wind speed. The basic ultimate design wind speed, V_{ult} , in miles per hour (mph), for the determination of the wind loads shall be determined by ~~Figure 1609~~ Figures 1609A, 1609B, and 1609C. The ultimate design wind speed, V_{ult} , for use in the design of Risk Category II buildings and structures shall be obtained from Figure 1609A. The ultimate design wind speed, V_{ult} , for use in the design of Risk Categories III and IV buildings and structures shall be obtained from Figure 1609B. The ultimate design wind speed, V_{ult} , for use in the design of Risk Category I buildings and structures shall be obtained from Figure 1609C. ~~Wind~~ The ultimate design wind speeds for localities in special wind regions, near mountainous terrains, and near gorges shall be based on elevation. Areas at 4,000 feet in elevation or higher shall use ~~440~~ 142 V

mph (48.4 m/s) (62.5 m/s) and areas under 4,000 feet in elevation shall use ~~90~~ 116 V mph (~~39.6 m/s~~) (51 m/s). Gorge areas shall be based on the highest recorded speed per locality or in accordance with local jurisdiction requirements determined in accordance with Section ~~6.5.4~~ 26.5.1 of ASCE 7.

In nonhurricane-prone regions, when the ~~basic ultimate design~~ wind speed, V_{ult} , is estimated from regional climatic data, the ~~basic ultimate design~~ wind speed, V_{ult} , shall be ~~not less than the wind speed associated with an annual probability of 0.02 (50 year mean recurrence interval), and the estimate shall be adjusted for equivalence to a three-second gust wind speed at 33 feet (10 m) above ground in exposure Category C. The data analysis shall be performed determined~~ in accordance with Section ~~6.5.4.2~~ 26.5.3 of ASCE 7.

B. Add Section 1612.1.1 to the IBC to read:

1612.1.1 Elevation of manufactured homes. New or replacement manufactured homes to be located in any flood hazard zone shall be placed in accordance with the applicable elevation requirements of this code.

Exception: Manufactured homes installed on sites in an existing manufactured home park or subdivision shall be permitted to be placed so that the manufactured home chassis is supported by reinforced piers or other foundation elements of at least equivalent strength that are no less than 36 inches (914 mm) above grade in lieu of being elevated at or above the base flood elevation provided no manufactured home at the same site has sustained flood damage exceeding 50% of the market value of the home before the damage occurred.

13VAC5-63-280. Chapter 17 Structural tests and special inspections.

A. Change Section 1703.1 of the IBC to read:

1703.1 Approved agency. An approved agency responsible for laboratory testing or special inspections, or both, must comply with the qualification, certification and experience requirements of ASTM E329 or the alternatives listed herein.

B. Change Section 1703.1.1 of the IBC to read:

1703.1.1 ~~Independent~~ Independence. An approved agency shall be objective and competent. The agency shall also disclose possible conflicts of interest so that objectivity can be confirmed. The special inspector and their agents shall be independent from the person, persons or contractor responsible for the physical construction of the project requiring special inspections.

C. Change Section 1703.1.3 of the IBC to read:

1703.1.3 Personnel. An approved agency shall employ experienced personnel educated in conducting, supervising and evaluating tests or inspections, or both. Upon request by the building official, documentation shall be provided demonstrating the applicable agency's accreditation as

noted in ASTM E329 and individuals' resumes indicating pertinent training, certifications and other qualifications for special inspection personnel associated with the proposed construction requiring special inspections. The building official may prescribe the manner of qualification documentation and frequency of updating information regarding agency or individual inspector approval.

Firms providing special inspection services or individual inspectors seeking approval of alternative certifications or qualifications, or both, listed in ASTM E329 may submit documentation demonstrating equivalency. This documentation may include evidence of meeting other recognized standards or alternative certifications to demonstrate that the minimum qualifications, certification and experience intended by ASTM E329 have been met. The building official may, if satisfied that equivalency has been demonstrated, approve the credentials of the firm or individual.

D. Change Section ~~1704.1~~ 1704.2 of the IBC to read:

~~1704.1. General~~ 1704.2 Special inspections. Where application is made for construction as described in this section, the owner shall employ one or more special inspectors to provide inspections during construction on the types of work listed under Section 1704. All individuals or agents performing special inspection functions shall operate under the direct supervision of an RDP in responsible charge of special inspection activities, also known as the "special inspector." The special inspector shall ensure that the individuals under their charge are performing only those special inspections or laboratory testing that are consistent with their knowledge, training and certification for the specified inspection or laboratory testing.

Exceptions:

1. Special inspections are not required for work of a minor nature or as warranted by conditions in the jurisdiction as approved by the building official.
2. Special inspections are not required for building components unless the design involves the practice of professional engineering or architecture as defined by the laws of this Commonwealth and regulations governing the professional registration and certification of engineers and architects.
3. Unless otherwise required by the building official, special inspections are not required for occupancies in Groups R-3, R-4 or R-5 and occupancies in Group U that are accessory to a residential occupancy including, but not limited to, those listed in Section 312.1.

E. Change Section ~~1704.1.1~~ 1704.2.3 of the IBC to read:

~~1704.1.1~~ 1704.2.3 Statement of special inspections. The permit applicant shall submit a statement of special inspections prepared by the RDP in responsible charge in

Regulations

accordance with Section 111.1. This statement shall be in accordance with Section ~~1705~~ 1704.3.

Exceptions:

1. A statement of special inspections is not required for structures designed and constructed in accordance with the conventional construction provisions of Section 2308.
2. The statement of special inspections is permitted to be prepared by a qualified person approved by the building official for construction not designed by a registered design professional.

F. Change category "12" of Table ~~1704.4~~ 1705.3 of the IBC to read:

Verifica-tion and inspection	Contin-uous	Periodic	Refer-enced Standard	IBC Reference
12. Inspect formwork for shape, location and dimensions of the concrete member being formed, shoring and reshoring.	--	X	ACI 318: 6.1, 6.2 <u>6.1.1</u>	1906 --

13VAC5-63-295. Chapter 23 Wood.

Change Item 3.2 of Section 2308.2 of the IBC to read:

3.2. Live loads shall not exceed 40 psf (1916 N/m²) for floors.

Exception: Concrete slab-on-grade live load limited only by allowable soil bearing pressure.

13VAC5-63-300. Chapter 27 Electrical.

A. Change Section 2701.1 of the IBC to read:

2701.1 Scope. This chapter governs the electrical components, equipment and systems used in buildings and structures covered by this code. Electrical components, equipment and systems shall be designed and constructed in accordance with the provisions of this code and NFPA 70.

B. Add Section 2701.1.1 to the IBC to read:

2701.1.1 Changes to NFPA 70. The following change shall be made to NFPA 70:

1. Change Sections 334.10(2) and 334.10(3) of NFPA 70 to read:

- (2) Multifamily dwellings not exceeding four floors above grade and multifamily dwellings of any height permitted to be of Types III, IV and V construction except in any case as prohibited in 334.12.

(3) Other structures not exceeding four floors above grade and other structures of any height permitted to be of Types III, IV and V construction except in any case as prohibited in 334.12. In structures exceeding four floors above grade, cables shall be concealed within walls, floors or ceilings that provide a thermal barrier of material that has at least a 15-minute finish rating as identified in listings of fire-rated assemblies.

For the purpose of Items 2 and 3 above, the first floor of a building shall be that floor that has 50% or more of the exterior wall surface area level with or above finished grade. One additional level that is the first level and not designed for human habitation and used only for vehicle parking, storage or similar use shall be permitted.

2. Change Exception 2 to Section 700.12(F) of NFPA 70 to read:

2. Where the normal power branch circuits that supply luminaries providing illumination immediately on the inside and outside of exit doors are supplied by the same service or feeder, the remote heads providing emergency illumination for the exterior of an exit door shall be permitted to be supplied by the unit equipment serving the area immediately inside the exit door.

C. Add Section 2701.1.2 to the IBC to read:

2701.1.2 Temporary connection to dwelling units. The building official shall give permission to energize the electrical service equipment of a one- or two-family dwelling unit when all of the following requirements have been approved:

1. The service wiring and equipment, including the meter socket enclosure, shall be installed and the service wiring terminated.
2. The grounding electrode system shall be installed and terminated.
3. At least one receptacle outlet on a ground fault protected circuit shall be installed and the circuit wiring terminated.
4. Service equipment covers shall be installed.
5. The building roof covering shall be installed.
6. Temporary electrical service equipment shall be suitable for wet locations unless the interior is dry and protected from the weather.

D. Add Section 2701.1.3 to the IBC to read:

2701.1.3 Assisted living facility generator requirements. Generators installed to comply with regulations for assisted living facilities licensed by the Virginia Department of Social Services shall be permitted to be optional standby systems.

E. Change Section 2702.2.17 of the IBC to read:

2702.2.17 Group I-2 and I-3 occupancies. Emergency power shall be provided in accordance with Section 407.11 for Group I-2 occupancies licensed by the Virginia

Department of Health as a hospital, nursing or hospice facility. Emergency power shall be provided for doors in Group I-3 occupancies in accordance with Section 408.4.2.

13VAC5-63-310. Chapter 28 Mechanical systems.

A. Change Section 2801.1 of the IBC to read:

2801.1 Scope. Mechanical appliances, equipment and systems shall be constructed and installed in accordance with this chapter, the ~~International Mechanical Code IMC~~ and the ~~International Fuel Gas Code IFGC~~. Masonry chimneys, fireplaces and barbecues shall comply with the ~~International Mechanical Code IMC~~ and Chapter 21 of this code.

Exception: This code shall not govern the construction of water heaters, boilers and pressure vessels to the extent which they are regulated by the Virginia Boiler and Pressure Vessel Regulations (16VAC25-50). However, the building official may require the owner of a structure to submit documentation to substantiate compliance with those regulations.

B. Add Section 2801.1.1 to the IBC to read:

2801.1.1 Required heating in dwelling units. Heating facilities shall be required in every dwelling unit or portion thereof which is to be rented, leased or let on terms, either expressed or implied, to furnish heat to the occupants thereof. The heating facilities shall be capable of maintaining the room temperature at 65°F (18°C) during the period from October 15 to May 1 during the hours between 6:30 a.m. and 10:30 p.m. of each day and not less than 60°F (16°C) during other hours when measured at a point three feet (914 mm) above the floor and three feet (914 mm) from the exterior walls. The capability of the heating system shall be based on the outside design temperature required for the locality by this code.

C. Add Section 2801.1.2 to the IBC to read:

2801.1.2 Required heating in nonresidential structures. Heating facilities shall be required in every enclosed occupied space in nonresidential structures. The heating facilities shall be capable of producing sufficient heat during the period from October 1 to May 15 to maintain a temperature of not less than 65°F (18°C) during all working hours. The required room temperature shall be measured at a point three feet (914 mm) above the floor and three feet (914 mm) from the exterior walls.

Processing, storage and operation areas that require cooling or special temperature conditions and areas in which persons are primarily engaged in vigorous physical activities are exempt from these requirements.

D. Add Section 2801.1.3 to the IBC to read:

2801.1.3 Changes to the ~~International Mechanical Code (IMC)~~ IMC. The following changes shall be made to the IMC:

1. Change Section 403.3 of the IMC to read:

403.3 Outdoor airflow rate. Ventilation systems shall be designed to have the capacity to supply the minimum outdoor airflow rate determined in accordance with this section. The occupant load utilized for design of the ventilation system shall not be less than the number determined from the estimated maximum occupant load rate indicated in Table 403.3. Ventilation rates for occupancies not represented in Table 403.3 shall be those for a listed occupancy classification that is most similar in terms of occupant density, activities and building construction; or shall be determined by an approved engineering analysis. The ventilation system shall be designed to supply the required rate of ventilation air continuously during the period the building is occupied, except as otherwise stated in other provisions of the code.

With the exception of smoking lounges and other designated areas where smoking is permitted, the ventilation rates in Table 403.3 are based on the absence of smoking in occupiable spaces.

Exception: The occupant load is not required to be determined based on the estimated maximum occupant load rate indicated in Table 403.3 where approved statistical data document the accuracy of an alternate anticipated occupant density.

2. Add the following areas to Table 403.3 of the IMC in the occupancy classifications shown:

OCCUPANCY CLASSIFICATION	People Outdoor Airflow Rate in Breathing Zone Cfm/person Occupant Density Number/1000 ft ²	Area People Outdoor Airflow Rate in Breathing Zone, R _{ap} cfm/ft ^{2a} cfm/person	Default Occupant Density #/1000 ft ^{2a} Area Outdoor Airflow Rate in Breathing Zone, R _a cfm/ft ^{2a}	Exhaust Airflow Rate Cfm/ft ^{2a}
Food and beverage service				
Bars or cocktail lounges designated as an area when <u>where</u> smoking is permitted ^b	30-100	-30	100-	
Cafeteria or fast food designated as an area when <u>where</u> smoking is permitted ^b	20-100	-20	100-	
Dining rooms	20-70	-20	70-	

Regulations

designated as an area when where smoking is permitted ^b				
Public spaces				
Lounges designated as an area where smoking is permitted ^b	30-100	-30	100-	

3. ~~Add~~ Change Section 505.1 of the IMC to read:

505.1 Domestic systems. Where domestic range hoods and domestic appliances equipped with downdraft exhaust are provided, such hoods and appliances shall discharge to the outdoors through sheet metal ducts constructed of galvanized steel, stainless steel, aluminum, or copper. Such ducts shall have smooth inner walls, shall be air tight, shall be equipped with a backdraft damper, and shall be independent of all other exhaust systems.

Exceptions:

1. In Group R buildings, where installed in accordance with the manufacturer's installation instructions and where mechanical or natural ventilation is otherwise provided in accordance with Chapter 4, listed and labeled ductless range hoods shall not be required to discharge to the outdoors.

2. Ducts for domestic kitchen cooking appliances equipped with downdraft exhaust systems shall be permitted to be constructed of Schedule 40 PVC pipe and fittings provided that the installation complies with all of the following:

2.1. The PVC duct shall be installed under a concrete slab poured on grade.

2.2. The underfloor trench in which the PVC duct is installed shall be completely backfilled with sand or gravel.

2.3. The PVC duct shall extend not more than 1 inch (25 mm) above the indoor concrete floor surface.

2.4. The PVC duct shall extend not more than 1 inch (25 mm) above grade outside of the building.

2.5. The PVC duct shall be solvent cemented.

4. Add Section 505.3 to the IMC to read:

505.3 Other than Group R. In other than Group R occupancies, where electric domestic cooking appliances are utilized for domestic purposes, such appliances shall be provided with domestic range hoods. Hoods and exhaust systems for such electric domestic cooking appliances shall be in accordance with Sections 505.1 and 505.2. In other than Group R occupancies, where fuel-fired domestic cooking appliances are utilized for

domestic purposes, a Type I or Type II hood shall be provided as required for the type of appliances and processes in accordance with Section 507.2.

5. Change Section 507.2.3 of the IMC to read:

507.2.3 Domestic cooking appliances used for commercial purposes. Domestic cooking appliances utilized for commercial purposes shall be provided with a Type I or Type II hood as required for the type of appliances and processes in accordance with Sections 507.2, 507.2.1, and 507.2.2. Domestic cooking appliances utilized for domestic purposes shall comply with Section 505.

6. Change Section 801.1.1 to 908.5 of the IMC to read:

~~801.1.1 Equipment changes. Upon the replacement or new installation of any fuel burning appliances or equipment in existing buildings, an inspection or inspections shall be conducted to ensure that the connected vent or chimney systems comply with the following:~~

~~1. Vent or chimney systems are sized in accordance with this code.~~

~~2. Vent or chimney systems are clean, free of any obstruction or blockages, defects or deterioration and are in operable condition.~~

~~Where not inspected by the local building department, persons performing such changes or installations shall certify to the building official that the requirements of Items 1 and 2 of this section are met.~~

908.5 Water supply. Cooling towers, evaporative coolers, and fluid coolers shall be provided with an approved water supply and sized for peak demand. The quality of the water shall be provided in accordance the equipment manufacturer's recommendations. The piping system and protection of the potable water supply shall be installed as required by the IPC.

~~4. 7.~~ Change ~~Item 4~~ of Section ~~1101.10~~ 928.1 of the IMC to read:

~~1101.10 Locking access port caps. Refrigerant circuit access ports located outdoors shall be fitted with locking-type tamper resistant caps or shall be otherwise secured to prevent unauthorized access.~~

4. Be provided with an approved water supply and sized for peak demand. The quality of the water shall be provided in accordance the equipment manufacturer's recommendations. The piping system and protection of the potable water supply shall be installed as required by the IPC.

E. Add Section 2801.1.4 to the IBC to read:

~~2801.1.4 Changes to the International Fuel Gas Code IFGC. The following changes shall be made to the International Fuel Gas Code IFGC:~~

1. Change Section 301.1 of the ~~International Fuel Gas Code IFGC~~ to read:

301.1 Scope. This code shall apply to the installation of fuel gas piping systems, fuel gas utilization equipment, and related accessories as follows:

1. Coverage of piping systems shall extend from the point of delivery to the connections with gas utilization equipment. (See "point of delivery.")

2. Systems with an operating pressure of 125 psig (862 kPa gauge) or less.

Piping systems for gas-air mixtures within the flammable range with an operating pressure of 10 psig (69 kPa gauge) or less.

LP-Gas piping systems with an operating pressure of 20 psig (140 kPa gauge) or less.

3. Piping systems requirements shall include design, materials, components, fabrication, assembly, installation, testing and inspection.

4. Requirements for gas utilization equipment and related accessories shall include installation, combustion and ventilation air and venting.

This code shall not apply to the following:

1. Portable LP-Gas equipment of all types that are not connected to a fixed fuel piping system.

2. Installation of farm equipment such as brooders, dehydrators, dryers, and irrigation equipment.

3. Raw material (feedstock) applications except for piping to special atmosphere generators.

4. Oxygen-fuel gas cutting and welding systems.

5. Industrial gas applications using gases such as acetylene and acetylenic compounds, hydrogen, ammonia, carbon monoxide, oxygen, and nitrogen.

6. Petroleum refineries, pipeline compressor or pumping stations, loading terminals, compounding plants, refinery tank farms, and natural gas processing plants.

7. Integrated chemical plants or portions of such plants where flammable or combustible liquids or gases are produced by chemical reactions or used in chemical reactions.

8. LP-Gas installations at utility gas plants.

9. Liquefied natural gas (LNG) installations.

10. Fuel gas piping in power and atomic energy plants.

11. Proprietary items of equipment, apparatus, or instruments such as gas generating sets, compressors, and calorimeters.

12. LP-Gas equipment for vaporization, gas mixing, and gas manufacturing.

13. Temporary LP-Gas piping for buildings under construction or renovation that is not to become part of the permanent piping system.

14. Installation of LP-Gas systems for railroad switch heating.

15. Installation of LP-Gas and compressed natural gas (CNG) systems on vehicles.

16. Except as provided in Section 401.1.1, gas piping, meters, gas pressure regulators, and other appurtenances used by the serving gas supplier in the distribution of gas, other than undiluted LP-Gas.

17. Building design and construction, except as specified herein.

2. Add Section 404.9.3 ~~404.11.3~~ to the ~~International Fuel Gas Code IFGC~~ to read:

~~404.9.3~~ 404.11.3 Coating application. Joints in gas piping systems shall not be coated prior to testing and approval.

~~3. Add Section 501.1.1 to the International Fuel Gas Code to read:~~

~~501.1.1 Equipment changes. Upon the replacement or new installation of any fuel burning appliances or equipment in existing buildings, an inspection or inspections shall be conducted to ensure that the connected vent or chimney systems comply with the following:~~

~~1. Vent or chimney systems are sized in accordance with this code.~~

~~2. Vent or chimney systems are clean, free of any obstruction or blockages, defects or deterioration and are in operable condition.~~

~~Where not inspected by the local building department, persons performing such changes or installations shall certify to the building official that the requirements of Items 1 and 2 of this section are met.~~

13VAC5-63-320. Chapter 29 Plumbing systems.

A. Change Section 2901.1 of the IBC to read:

2901.1 Scope. The provisions of this chapter and the ~~International Plumbing Code (IPC)~~ IPC shall govern the design and installation of all plumbing systems and equipment, except that as provided for in Section 103.11 for functional design, water supply sources and sewage disposal systems are regulated and approved by the Virginia Department of Health and the Virginia Department of Environmental Quality. The approval of pumping and electrical equipment associated with such water supply sources and sewage disposal systems shall, however, be the responsibility of the building official.

Note: See also the Memorandum of Agreement in the "Related Laws Package," which is available from DHCD.

B. Add Section 2901.1.1 to the IBC to read:

~~2901.1.1 Use of Appendix C of the IPC for gray water and rain water recycling systems. In addition to other applicable provisions of the IPC, gray water recycling systems and rain water recycling systems shall comply~~

Regulations

with the provisions in Appendix C of the IPC. In the use of Appendix C of the IPC for rain water recycling systems, the term "rain water" shall be substituted for the term "gray water." Gray water recycling systems and rain water recycling systems shall be separate systems and shall not be interconnected.

C. ~~B.~~ Add Section ~~2901.1.2~~ 2901.1.1 to the IBC to read:

~~2901.1.2~~ 2901.1.1 Changes to the IPC. The following changes shall be made to the IPC:

1. Add the following definitions to the IPC to read:

Nonpotable fixtures and outlets. Fixtures and outlets that are not dependent on potable water for the safe operation to perform their intended use. Such fixtures and outlets may include, but are not limited to water closets, urinals, irrigation, mechanical equipment, and hose connections to perform operations, such as vehicle washing and lawn maintenance.

Nonpotable water systems. Water systems for the collection, treatment, storage, distribution, and use or reuse of nonpotable water. Nonpotable systems include reclaimed water, rainwater, and gray water systems.

Rainwater. Natural precipitation, including snow melt, from roof surfaces only.

Reclaimed water. Reclaimed water means water resulting from the treatment of domestic, municipal, or industrial wastewater that is suitable for a water reuse that would not otherwise occur. Specifically excluded from this definition is "gray water."

Stormwater. Precipitation that is discharged across the land surface or through conveyances to one or more waterways and that may include stormwater runoff, snow melt runoff, and surface runoff and drainage.

2. Change the following definition in the IPC to read:

Gray water. Water discharged from lavatories, bathtubs, showers, clothes washers, and laundry trays.

3. Change the exception to Section 301.3 of the IPC to read:

~~301.3 Connections to drainage system.~~ All plumbing fixtures, drains, appurtenances and appliances used to receive or discharge liquid wastes or sewage shall be directly connected to the sanitary drainage system of the building or premises, in accordance with the requirements of this code. This section shall not be construed to prevent indirect waste systems required by Chapter 8.

Exception: Bathtubs, showers, lavatories, clothes washers and laundry trays shall not be required to discharge to the sanitary drainage system where such fixtures discharge to an approved nonpotable gray water system ~~or rain water system for flushing of water closets and urinals or for subsurface landscape irrigation~~ in accordance with the applicable provisions of Chapter 13.

2. ~~4.~~ Delete Sections 311 and 311.1 of the IPC.

3. ~~Change 5.~~ Modify the Group A-5 "Description" category of Table 403.1 of the IPC to read:

Stadiums, amusement parks, pools, bleachers, and grandstands for outdoor sporting events and activities^h

6. Add footnote "h" to Table 403.1 of the IPC to read:

h. The occupant load for pools shall be in accordance with the "Skating rinks, swimming pools" category of Table 1004.1.2 of the IBC.

7. Add Section 403.1.3 and Table 403.1.3 to the IPC to read:

403.1.3 Marina fixtures. Notwithstanding any provision to the contrary, plumbing fixtures shall be provided for marinas in the minimum number shown in Table 403.1.3. Fixtures shall be located within 500 feet walking distance from the shore end of any dock they serve. Separate facilities shall be provided for each sex with an equal number of fixtures of each type in each facility, except that separate facilities are not required where the number of slips is less than 25. Urinals may be substituted for up to 50% of water closets.

<u>Table 403.1.3</u> <u>Minimum Number of Required Plumbing Fixtures for Marinas</u>			
<u>Number of Slips</u>	<u>Plumbing Fixtures</u>		
	<u>Water Closets</u>	<u>Lavatories</u>	<u>Showers</u>
<u>1 - 24</u>	<u>1</u>	<u>1</u>	<u>1</u>
<u>25 - 49</u>	<u>4</u>	<u>4</u>	<u>2</u>
<u>50 - 99</u>	<u>6</u>	<u>4</u>	<u>2</u>
<u>100 - 149</u>	<u>8</u>	<u>6</u>	<u>4</u>
<u>150 - 199</u>	<u>10</u>	<u>8</u>	<u>4</u>
<u>200 - 249</u>	<u>12</u>	<u>10</u>	<u>6</u>
<u>250 or greater</u>	<u>Two additional fixtures of each type for each 100 additional slips.</u>		

8. Change Section 403.3.3 of the IPC to read:

403.3.3 Location of toilet facilities in occupancies other than malls. In occupancies other than covered and open mall buildings, the required public and employee toilet facilities shall be located not more than one story above or below the space required to be provided with toilet facilities, and the path of travel to such facilities shall not exceed a distance of 500 feet (152 m).

Exceptions:

1. The location and maximum travel distances to required employee facilities in factory and industrial occupancies

are permitted to exceed that required by this section, provided that the location and maximum travel distance are approved.

2. The location and maximum travel distances to the required public facilities located on cemetery property are permitted to exceed that required by this section, provided that the location and maximum travel distance are located on the same property and approved.

9. Change Section 405.3.2 of the IPC to read:

405.3.2 Public lavatories. In employee and public toilet rooms, the required lavatory shall be located in the same room as the required water closet.

Exception: In educational use occupancies, the required lavatory shall be permitted to be located adjacent to the room or space containing the water closet provided that not more than one operational door is between the water closet and the lavatory.

10. Add Section ~~602.1~~ of 602.2.1 the IPC to read:

~~602.1 General. Every structure equipped with plumbing fixtures and utilized for human occupancy or habitation shall be provided with a potable supply of water in the amounts and at the pressures specified in this chapter. This shall not prohibit the use of reclaimed water distribution systems installed in accordance with this code and the Virginia Water Reclamation and Reuse Regulation (9VAC25-740).~~

602.2.1 Nonpotable fixtures and outlets. Nonpotable water shall be permitted to serve nonpotable type fixtures and outlets in accordance with Chapter 13.

4. Change Section 604.1 of the IPC to read:

~~604.1 General. The design of the water distribution system, including any reclaimed water distribution systems governed by the Virginia Water Reclamation and Reuse Regulation (9VAC25-740), shall conform to accepted engineering practice. Methods utilized to determine pipe sizes shall be approved.~~

5. Add an exception to Section 608.8 of the IPC to read:

~~Exception: Reclaimed water supply systems shall be identified in accordance with the provisions of the Virginia Water Reclamation and Reuse Regulation (9VAC25-740).~~

6. Change Section 608.8.2 of the IPC to read:

~~608.8.2 Color. The color of the pipe identification shall be discernable and consistent throughout the building. The color purple shall be used to identify rain and gray water distribution systems.~~

7. ~~11.~~ Delete Section 701.9 of the IPC.

8. ~~12.~~ Add Section 703.6 of the IPC to read:

703.6 Tracer wire. Nonmetallic sanitary sewer piping that discharges to public systems shall be locatable. An insulated copper tracer wire, 18 AWG minimum in size

and suitable for direct burial or an equivalent product, shall be utilized. The wire shall be installed in the same trench as the sewer within 12 inches (305 mm) of the pipe and shall be installed to within five feet (1524 mm) of the building wall to the point where the building sewer intersects with the public system. At a minimum, one end of the wire shall terminate above grade in an accessible location that is resistant to physical damage, such as with a cleanout or at the building wall.

13. Add an exception to Section 1101.2 of the IPC to read:

Exception. Rainwater nonpotable water systems shall be permitted in accordance with Chapter 13.

14. Add Chapter 13 entitled "Nonpotable Water Systems" to the IPC.

15. Add Section 1301 entitled "General" to the IPC.

16. Add Sections 1301.1 through 1301.18, including subsections, to the IPC to read:

1301.1 Scope. The provisions of Chapter 13 shall govern the materials, design, construction, and installation of nonpotable water systems subject to this code. In addition to the applicable provision of this section, reclaimed water shall comply with the requirements of Section 1304.

1301.1.1 Design of nonpotable water systems. All portions of nonpotable water systems subject to this code shall be constructed using the same standards and requirements for the potable water systems or drainage systems as provided for in this code unless otherwise specified in this chapter.

1301.2 Makeup water. Makeup water shall be provided for all nonpotable water supply systems. The makeup water system shall be designed and installed to provide supply of water in the amounts and at the pressures specified in this code. The makeup water supply shall be potable and be protected against backflow in accordance with the applicable requirements of Section 608.

1301.2.1 Makeup water sources. Potable water shall be provided as makeup water for reclaimed water systems. Nonpotable water shall be permitted to serve as makeup water for gray water and rainwater systems.

1301.2.2 Makeup water supply valve. A full-open valve shall be provided on the makeup water supply line.

1301.2.3 Control valve alarm. Makeup water systems shall be fitted with a warning mechanism that alerts the user to a failure of the inlet control valve to close correctly. The alarm shall activate before the water within the storage tank begins to discharge into the overflow system.

1301.3 Sizing. Nonpotable water distribution systems shall be designed and sized for peak demand in accordance with approved engineering practice methods that comply with the applicable provisions of Chapter 6.

Regulations

1301.4 Signage required. All nonpotable water outlets, other than water closets and urinals, such as hose connections, open-ended pipes, and faucets shall be identified at the point of use for each outlet with signage that reads as follows: "Nonpotable water is utilized for (insert application name). Caution: nonpotable water. DO NOT DRINK." The words shall be legibly and indelibly printed on a tag or sign constructed of corrosion-resistant waterproof material or shall be indelibly printed on the fixture. The letters of the words shall be not less than 0.5 inches (12.7 mm) in height and in colors in contrast to the background on which they are applied. The pictograph shown in Figure 1301.4 shall appear on the signage required by this section.



1301.5 Potable water supply system connections. Where a potable water supply system is connected to a nonpotable water system, the potable water supply shall be protected against backflow in accordance with the applicable provisions of Section 608.

1301.6 Nonpotable water system connections. Where a nonpotable water system is connected and supplies water to another nonpotable water system, the nonpotable water system that supplies water shall be protected against backflow in accordance with the applicable provisions of Section 608.

1301.7 Approved components and materials. Piping, plumbing components, and materials used in the nonpotable water drainage and distribution systems shall be approved for the intended application and compatible with the water and any disinfection or treatment systems used.

1301.8 Insect and vermin control. Nonpotable water systems shall be protected to prevent the entrance of insects and vermin into storage and piping systems. Screen materials shall be compatible with system material and shall not promote corrosion of system components.

1301.9 Freeze protection. Nonpotable water systems shall be protected from freezing in accordance with the applicable provisions of Chapter 3.

1301.10 Nonpotable water storage tanks. Nonpotable water storage tanks shall be approved for the intended application and comply with Sections 1301.10.1 through 1301.10.12.

1301.10.1 Sizing. The holding capacity of storage tanks shall be sized for the intended use.

1301.10.2 Inlets. Storage tank inlets shall be designed to introduce water into the tank and avoid agitating the contents of the storage tank. The water supply to storage tanks shall be controlled by fill valves or other automatic supply valves designed to stop the flow of incoming water before the tank contents reach the overflow pipes.

1301.10.3 Outlets. Outlets shall be located at least 4 inches (102 mm) above the bottom of the storage tank and shall not skim water from the surface.

1301.10.4 Materials and location. Storage tanks shall be constructed of material compatible with treatment systems used to treat water. Above grade storage vessels shall be constructed using opaque, UV-resistant materials such as tinted plastic, lined metal, concrete, or wood or painted to prevent algae growth. Above grade storage tanks shall be protected from direct sunlight unless their design specifically incorporates the use of the sunlight heat transfer. Wooden storage tanks shall be provided with a flexible liner. Storage tanks and their manholes shall not be located directly under soil or waste piping or sources of contamination.

1301.10.5 Foundation and supports. Storage tanks shall be supported on a firm base capable of withstanding the storage tank's weight when filled to capacity. Storage tanks shall be supported in accordance with the applicable provisions of the IBC.

1301.10.5.1 Ballast. Where the soil can become saturated, an underground storage tank shall be ballasted, or otherwise secured, to prevent the effects of buoyancy. The combined weight of the tank and hold down ballast shall meet or exceed the buoyancy force of the tank. Where the installation requires a foundation, the foundation shall be flat and shall be designed to support the storage tank weight when full, consistent with the bearing capability of adjacent soil.

1301.10.5.2 Structural support. Where installed below grade, storage tank installations shall be designed to withstand earth and surface structural loads without damage.

1301.10.6 Overflow. The storage tank shall be equipped with an overflow pipe having a diameter not less than that shown in Table 606.5.4. The overflow outlet shall discharge at a point not less than 6 inches (152 mm) above the roof or roof drain, floor or floor drain, or over an open water-supplied fixture. The overflow outlet shall terminate through a check valve. Overflow pipes shall not be directed on walkways. The overflow drain shall

not be equipped with a shutoff valve. A minimum of one cleanout shall be provided on each overflow pipe in accordance with the applicable provisions of Section 708.

1301.10.7 Access. A minimum of one access opening shall be provided to allow inspection and cleaning of the tank interior. Access openings shall have an approved locking device or other approved method of securing access. Below grade storage tanks, located outside of the building, shall be provided with either a manhole not less than 24 inches (610 mm) square or a manhole with an inside diameter not less than 24 inches (610 mm). The design and installation of access openings shall prohibit surface water from entering the tank. Each manhole cover shall have an approved locking device or other approved method of securing access.

Exception: Storage tanks under 800 gallons (3028 L) in volume installed below grade shall not be required to be equipped with a manhole, but shall have an access opening not less than 8 inches (203 mm) in diameter to allow inspection and cleaning of the tank interior.

1301.10.8 Venting. Storage tanks shall be vented. Vents shall not be connected to sanitary drainage system. Vents shall be at least equal in size to the internal diameter of the drainage inlet pipe or pipes connected to the tank. Where installed at grade, vents shall be protected from contamination by means of a U-bend installed with the opening directed downward. Vent outlets shall extend a minimum of 12 inches (304.8 mm) above grade, or as necessary to prevent surface water from entering the storage tank. Vent openings shall be protected against the entrance of vermin and insects. Vents serving gray water tanks shall terminate in accordance with the applicable provisions of Sections 903 and 1301.8.

1301.10.9 Drain. Where drains are provided they shall be located at the lowest point of the storage tank. The tank drain pipe shall discharge as required for overflow pipes and shall not be smaller in size than specified in Table 606.5.7. A minimum of one cleanout shall be provided on each drain pipe in accordance with Section 708.

1301.10.10 Labeling and signage. Each nonpotable water storage tank shall be labeled with its rated capacity and the location of the upstream bypass valve. Underground and otherwise concealed storage tanks shall be labeled at all access points. The label shall read: "CAUTION: NONPOTABLE WATER – DO NOT DRINK." Where an opening is provided that could allow the entry of personnel, the opening shall be marked with the words: "DANGER – CONFINED SPACE." Markings shall be indelibly printed on a tag or sign constructed of corrosion-resistant waterproof material mounted on the tank or shall be indelibly printed on the tank. The letters of the words shall be not less than 0.5 inches (12.7 mm) in height and shall be of a color in contrast with the background on which they are applied.

1301.10.11 Storage tank tests. Storage tanks shall be tested in accordance with the following:

1. Storage tanks shall be filled with water to the overflow line prior to and during inspection. All seams and joints shall be left exposed and the tank shall remain watertight without leakage for a period of 24 hours.

2. After 24 hours, supplemental water shall be introduced for a period of 15 minutes to verify proper drainage of the overflow system and verify that there are no leaks.

3. Following a successful test of the overflow, the water level in the tank shall be reduced to a level that is at 2 inches (50.8 mm) below the makeup water offset point. The tank drain shall be observed for proper operation. The makeup water system shall be observed for proper operation, and successful automatic shutoff of the system at the refill threshold shall be verified. Water shall not be drained from the overflow at any time during the refill test.

4. Air tests shall be permitted in lieu of water testing as recommended by the tank manufacturer or the tank standard.

1301.10.12 Structural strength. Storage tanks shall meet the applicable structural strength requirements of the IBC.

1301.11 Trenching requirements for nonpotable water system piping. Underground nonpotable water system piping shall be horizontally separated from the building sewer and potable water piping by 5 feet (1524 mm) of undisturbed or compacted earth. Nonpotable water system piping shall not be located in, under, or above sewage systems cesspools, septic tanks, septic tank drainage fields, or seepage pits. Buried nonpotable system piping shall comply with the requirements of this code for the piping material installed.

Exceptions:

1. The required separation distance shall not apply where the bottom of the nonpotable water pipe within 5 feet (1524 mm) of the sewer is equal to or greater than 12 inches (305 mm) above the top of the highest point of the sewer and the pipe materials conforms to Table 702.3.

2. The required separation distance shall not apply where the bottom of the potable water service pipe within 5 feet (1524 mm) of the nonpotable water pipe is a minimum of 12 inches (305 mm) above the top of the highest point of the nonpotable water pipe and the pipe materials comply with the requirements of Table 605.4.

3. Nonpotable water pipe is permitted to be located in the same trench with building sewer piping, provided that such sewer piping is constructed of materials that comply with the requirements of Table 702.2.

4. The required separation distance shall not apply where a nonpotable water pipe crosses a sewer pipe, provided that the pipe is sleeved to at least 5 feet (1524 mm)

Regulations

horizontally from the sewer pipe centerline on both sides of such crossing with pipe materials that comply with Table 702.2.

5. The required separation distance shall not apply where a potable water service pipe crosses a nonpotable water pipe provided that the potable water service pipe is sleeved for a distance of at least 5 feet (1524 mm) horizontally from the centerline of the nonpotable pipe on both sides of such crossing with pipe materials that comply with Table 702.2.

1301.12 Outdoor outlet access. Sillcocks, hose bibs, wall hydrants, yard hydrants, and other outdoor outlets that are supplied by nonpotable water shall be located in a locked vault or shall be operable only by means of a removable key.

1301.13 Drainage and vent piping and fittings. Nonpotable drainage and vent pipe and fittings shall comply with the applicable material standards and installation requirements in accordance with provisions of Chapter 7.

1301.13.1. Labeling and marking. Identification of nonpotable drainage and vent piping shall not be required.

1301.14 Pumping and control system. Mechanical equipment, including pumps, valves, and filters, shall be accessible and removable in order to perform repair, maintenance, and cleaning. The minimum flow rate and flow pressure delivered by the pumping system shall be designed for the intended application in accordance with the applicable provisions of Section 604.

1301.15 Water-pressure reducing valve or regulator. Where the water pressure supplied by the pumping system exceeds 80 psi (552 kPa) static, a pressure-reducing valve shall be installed to reduce the pressure in the nonpotable water distribution system piping to 80 psi (552 kPa) static or less. Pressure-reducing valves shall be specified and installed in accordance with the applicable provisions of Section 604.8.

1301.16 Distribution pipe. Distribution piping utilized in nonpotable water stems shall comply with Sections 1301.16.1 through 1301.16.4.

1301.16.1 Materials, joints, and connections. Distribution piping and fittings shall comply with the applicable material standards and installation requirements in accordance with applicable provisions of Chapter 6.

1301.16.2 Design. Distribution piping shall be designed and sized in accordance with the applicable provisions of Chapter 6.

1301.16.3 Labeling and marking. Distribution piping labeling and marking shall comply with Section 608.8.

1301.16.4 Backflow prevention. Backflow preventers shall be installed in accordance with the applicable provisions of Section 608.

1301.17 Tests and inspections. Tests and inspections shall be performed in accordance with Sections 1301.17.1 through 1301.17.5.

1301.17.1 Drainage and vent pipe test. Drain, waste, and vent piping used for gray water and rainwater nonpotable water systems shall be tested in accordance with the applicable provisions of Section 312.

1301.17.2 Storage tank test. Storage tanks shall be tested in accordance with the Section 1301.10.11.

1301.17.3 Water supply system test. Nonpotable distribution piping shall be tested in accordance with Section 312.5.

1301.17.4 Inspection and testing of backflow prevention assemblies. The testing of backflow preventers and backwater valves shall be conducted in accordance with Section 312.10.

1301.17.5 Inspection of vermin and insect protection. Inlets and vent terminations shall be visually inspected to verify that each termination is installed in accordance with Section 1301.10.8.

1301.18 Operation and maintenance manuals. Operations and maintenance materials for nonpotable water systems shall be provided as prescribed by the system component manufacturers and supplied to the owner to be kept in a readily accessible location.

17. Add Section 1302 entitled "Gray Water Nonpotable Water Systems" to the IPC.

18. Add Sections 1302.1 through 1302.6, including subsections, to the IPC to read:

1302.1 Gray water nonpotable water systems. This code is applicable to the plumbing fixtures, piping or piping systems, storage tanks, drains, appurtenances, and appliances that are part of the distribution system for gray water within buildings and to storage tanks and associated piping that are part of the distribution system for gray water outside of buildings. This code does not regulate equipment used for, or the methods of, processing, filtering, or treating gray water, that may be regulated by the Virginia Department of Health or the Virginia Department of Environmental Quality.

1302.1.1 Separate systems. Gray water nonpotable water systems, unless approved otherwise under the permit from the Virginia Department of Health, shall be separate from the potable water system of a building with no cross connections between the two systems except as permitted by the Virginia Department of Health.

1302.2 Water quality. Each application of gray water reuse shall meet the minimum water quality requirements set forth in Sections 1302.2.1 through 1302.2.4 unless otherwise superseded by other state agencies.

1302.2.1 Disinfection. Where the intended use or reuse application for nonpotable water requires disinfection or

other treatment or both, it shall be disinfected as needed to ensure that the required water quality is delivered at the point of use or reuse.

1302.2.2 Residual disinfectants. Where chlorine is used for disinfection, the nonpotable water shall contain not more than 4 parts per million (4 mg/L) of free chlorine, combined chlorine, or total chlorine. Where ozone is used for disinfection, the nonpotable water shall not exceed 0.1 parts per million (by volume) of ozone at the point of use.

1302.2.3 Filtration. Water collected for reuse shall be filtered as required for the intended end use. Filters shall be accessible for inspection and maintenance. Filters shall utilize a pressure gauge or other approved method to indicate when a filter requires servicing or replacement. Shutoff valves installed immediately upstream and downstream of the filter shall be included to allow for isolation during maintenance.

1302.2.4 Filtration required. Gray water utilized for water closet and urinal flushing applications shall be filtered by a 100 micron or finer filter.

1302.3 Storage tanks. Storage tanks utilized in gray water nonpotable water systems shall comply with Section 1301.10.

1302.4 Retention time limits. Untreated gray water shall be retained in storage tanks for a maximum of 24 hours.

1302.5 Tank Location. Storage tanks shall be located with a minimum horizontal distance between various elements as indicated in Table 1302.5.1.

Table 1302.5.1

Location of Nonpotable Gray Water Reuse Storage Tanks

<u>Element</u>	<u>Minimum Horizontal Distance from Storage Tank (feet)</u>
<u>Lot line adjoining private lots</u>	<u>5</u>
<u>Sewage systems</u>	<u>5</u>
<u>Septic tanks</u>	<u>5</u>
<u>Water wells</u>	<u>50</u>
<u>Streams and lakes</u>	<u>50</u>
<u>Water service</u>	<u>5</u>
<u>Public water main</u>	<u>10</u>

1302.6 Valves. Valves shall be supplied on gray water nonpotable water drainage systems in accordance with Sections 1302.6.1 and 1302.6.2.

1302.6.1 Bypass valve. One three-way diverter valve certified to NSF 50 or other approved device shall be

installed on collection piping upstream of each storage tank, or drainfield, as applicable, to divert untreated gray water to the sanitary sewer to allow servicing and inspection of the system. Bypass valves shall be installed downstream of fixture traps and vent connections. Bypass valves shall be labeled to indicate the direction of flow, connection, and storage tank or drainfield connection. Bypass valves shall be provided with access for operation and maintenance. Two shutoff valves shall not be installed to serve as a bypass valve.

1302.6.2 Backwater valve. Backwater valves shall be installed on each overflow and tank drain pipe to prevent unwanted water from draining back into the storage tank. If the overflow and drain piping arrangement is installed to physically not allow water to drain back into the tank, such as in the form of an air gap, backwater valves shall not be required. Backwater valves shall be constructed and installed in accordance with Section 715.

19. Add Section 1303 entitled "Rainwater Nonpotable Water Systems" to the IPC.

20. Add Sections 1303.1 through 1303.10, including subsections, to the IPC to read:

1303.1 General. The provisions of this section shall govern the design, construction, installation, alteration, and repair of rainwater nonpotable water systems for the collection, storage, treatment, and distribution of rainwater for nonpotable applications.

1303.2 Water quality. Each application of rainwater reuse shall meet the minimum water quality requirements set forth in Sections 1303.2.1 through 1303.2.4 unless otherwise superseded by other state agencies.

1303.2.1 Disinfection. Where the intended use or reuse application for nonpotable water requires disinfection or other treatment or both, it shall be disinfected as needed to ensure that the required water quality is delivered at the point of use or reuse.

1303.2.2 Residual disinfectants. Where chlorine is used for disinfection, the nonpotable water shall contain not more than 4 parts per million (4 mg/L) of free chlorine, combined chlorine, or total chlorine. Where ozone is used for disinfection, the nonpotable water shall not exceed 0.1 parts per million (by volume) of ozone at the point of use.

1303.2.3 Filtration. Water collected for reuse shall be filtered as required for the intended end use. Filters shall be accessible for inspection and maintenance. Filters shall utilize a pressure gauge or other approved method to indicate when a filter requires servicing or replacement. Shutoff valves installed immediately upstream and downstream of the filter shall be included to allow for isolation during maintenance.

Regulations

1303.2.4 Filtration required. Rainwater utilized for water closet and urinal flushing applications shall be filtered by a 100 micron or finer filter.

1303.3 Collection surface. Rainwater shall be collected only from aboveground impervious roofing surfaces constructed from approved materials. Overflow or discharge piping from appliances or equipment, or both, including but not limited to evaporative coolers, water heaters, and solar water heaters shall not discharge onto rainwater collection surfaces.

1303.4 Collection surface diversion. At a minimum, the first 0.04 inches (1.016 mm) of each rain event of 25 gallons (94.6 L) per 1000 square feet (92.9 m²) shall be diverted from the storage tank by automatic means and not require the operation of manually operated valves or devices. Diverted water shall not drain onto other collection surfaces that are discharging to the rainwater system or to the sanitary sewer. Such water shall be diverted from the storage tank and discharged in an approved location.

1303.5 Pre-tank filtration. Downspouts, conductors, and leaders shall be connected to a pre-tank filtration device. The filtration device shall not permit materials larger than 0.015 inches (0.4 mm).

1303.6 Roof gutters and downspouts. Gutters and downspouts shall be constructed of materials that are compatible with the collection surface and the rainwater quality for the desired end use. Joints shall be made watertight.

1303.6.1 Slope. Roof gutters, leaders, and rainwater collection piping shall slope continuously toward collection inlets. Gutters and downspouts shall have a slope of not less than 1 unit in 96 units along their entire length and shall not permit the collection or pooling of water at any point.

Exception: Siphonic roof drainage systems installed in accordance with Chapter 11 shall not be required to have slope.

1303.6.2 Size. Gutters and downspouts shall be installed and sized in accordance with Section 1106.6 and local rainfall rates.

1303.6.3 Cleanouts. Cleanouts or other approved openings shall be provided to permit access to all filters, flushes, pipes, and downspouts.

1303.7 Storage tanks. Storage tanks utilized in rainwater nonpotable water systems shall comply with Section 1301.10.

1303.8 Location. Storage tanks shall be located with a minimum horizontal distance between various elements as indicated in Table 1303.8.1.

<u>Table 1303.8.1</u> <u>Location of Rainwater Storage Tanks</u>	
<u>Element</u>	<u>Minimum Horizontal Distance from Storage Tank (feet)</u>
<u>Lot line adjoining private lots</u>	<u>5</u>
<u>Sewage systems</u>	<u>5</u>
<u>Septic tanks</u>	<u>5</u>

1303.9 Valves. Valves shall be installed in collection and conveyance drainage piping of rainwater nonpotable water systems in accordance with Sections 1303.9.1 and 1303.9.2.

1303.9.1 Influent diversion. A means shall be provided to divert storage tank influent to allow maintenance and repair of the storage tank system.

1303.9.2 Backwater valve. Backwater valves shall be installed on each overflow and tank drain pipe to prevent unwanted water from draining back into the storage tank. If the overflow and drain piping arrangement is installed to physically not allow water to drain back into the tank, such as in the form of an air gap, backwater valves shall not be required. Backwater valves shall be constructed and installed in accordance with Section 715.

1303.10 Tests and inspections. Tests and inspections shall be performed in accordance with Sections 1303.10.1 through 1303.10.2.

1303.10.1 Roof gutter inspection and test. Roof gutters shall be inspected to verify that the installation and slope is in accordance with Section 1303.6.1. Gutters shall be tested by pouring a minimum of one gallon of water into the end of the gutter opposite the collection point. The gutter being tested shall not leak and shall not retain standing water.

1303.10.2 Collection surface diversion test. A collection surface diversion test shall be performed by introducing water into the gutters or onto the collection surface area. Diversion of the first quantity of water in accordance with the requirements of Section 1303.4 shall be verified.

21. Add Section 1304 entitled "Reclaimed Water Systems" to the IPC.

22. Add Sections 1304.1 and 1304.2 to the IPC to read:

1304.1 General. Reclaimed water, water reclamation systems, reclaimed water distribution systems, and allowable nonpotable reuses of reclaimed water are as defined or specified in and governed by the Virginia Water Reclamation and Reuse Regulation (9VAC25-740). Permits from the Virginia State Water Control Board are required for such systems and reuses. The provisions of Section 1304 shall govern the design.

construction, installation, alterations, and repair of plumbing fixtures, piping or piping systems, storage tanks, drains, appurtenances, and appliances that are part of the distribution system for reclaimed water within buildings and to storage tanks for reclaimed water as defined in the Virginia Water Reclamation and Reuse Regulation (9VAC25-740) and associated piping outside of buildings that deliver reclaimed water into buildings. Where conflicts occur between this code and the Virginia Water Reclamation and Reuse Regulation (9VAC25-740), the provisions of the Virginia Water Reclamation and Reuse Regulation (9VAC25-740) shall apply unless determined otherwise by the Virginia Department of Environmental Quality and DHCD through a memorandum of agreement.

1304.2 Design of reclaimed water systems. The design of reclaimed water systems shall conform to applicable requirements of Section 1301.

Exception: The design of reclaimed water systems shall conform to applicable requirements of the Virginia Water Reclamation and Reuse Regulation (9VAC25-740) for the following:

1. Identification, labeling, and posting of signage for reclaimed water systems in lieu of signage requirements described in Section 1301.4.
2. Sizing of system storage as defined in the Virginia Water Reclamation and Reuse Regulation (9VAC25-740), in addition to storage sizing requirements described in Section 1301.10.1.
3. Signage and labeling for reclaimed water storage in addition to labeling and signage requirements described in Section 1301.10.10.
4. Minimum separation distances and configurations for in-ground reclaimed water distribution piping in lieu of trenching requirements for nonpotable water systems described in Section 1301.11.

23. Add the following referenced standard to Chapter 14 of the IPC:

<u>Standard Reference Number</u>	<u>Title</u>	<u>Referenced in Code Section Number</u>
<u>NSF/ANSI 50-09</u>	<u>Equipment for Swimming Pools, Spas, Hot Tubs and Other Recreational Water Facilities</u>	<u>1302.6.1</u>

C. Modify the Group A-5 "Description" category of Table 2902.1 of the IBC to read:

Stadiums, amusement parks, pools, bleachers, and grandstands for outdoor sporting events and activities^h

D. Add footnote "h" to Table 2902.1 of the IBC to read:

h. The occupant load for pools shall be in accordance with the "Skating rinks, swimming pools" category of Table 1004.1.2.

13VAC5-63-330. Chapter 30 Elevators and conveying systems.

A. Change Section 3002.4 of the IBC to read:

3002.4 Elevator car to accommodate ambulance stretcher. Where elevators are provided in buildings four or more stories above, or four or more stories below, grade plane, at least one elevator shall be provided for fire department emergency access to all floors. The elevator car shall be of such a size and arrangement to accommodate an ambulance stretcher 24 inches by 84 inches (610 mm by 2134 mm) with not less than five-inch (127 mm) radius corners, in the horizontal, open position and shall be identified by the international symbol for emergency medical services (star of life). The symbol shall not be less than three inches (76 mm) high and shall be placed inside on both sides of the hoistway door frame on the designated and alternate landing floors required to be established by ASME A17.1.

Exception: Elevators in multistory dwelling units or guest rooms.

B. Add ~~Change Section 3003.2.1 to~~ 3003.3 of the IBC to read:

~~3003.2.1 Standardized fire~~ 3003.3 Fire service elevator keys. ~~Where a key is required to operate the emergency function of an elevator, the key shall be~~ All elevators shall be equipped to operate with either a standardized or non-standardized fire service elevator key in accordance with the Virginia Statewide Fire Prevention Code (13VAC5-51) IFC.

C. Change Section 3006.4 of the IBC to read:

3006.4 Machine rooms and machinery spaces. Elevator machine rooms, rooms housing elevator controllers, and machinery spaces shall be enclosed with fire barriers constructed in accordance with Section 707 or horizontal assemblies constructed in accordance with Section ~~712~~ 711, or both. The fire-resistance rating shall not be less than the required rating of the hoistway enclosure served by the machinery. Openings in the fire barriers shall be protected with assemblies having a fire protection rating not less than that required for the hoistway enclosure doors.

Exceptions:

1. Where machine rooms, rooms housing elevator controllers, and machinery spaces do not abut and have no openings to the hoistway enclosure they serve, the fire barriers constructed in accordance with Section 707 or horizontal assemblies constructed in accordance with Section ~~712~~ 711, or both, shall be permitted to be reduced to a one-hour fire-resistance rating.

Regulations

2. In buildings four stories or less above grade plane when machine rooms, rooms housing elevator controllers, and machinery rooms do not abut and have no openings to the hoistway enclosure they serve, the machine room, room housing elevator controllers, and machinery spaces are not required to be fire-resistance rated.

D. Add Section 3006.7 to the IBC to read:

3006.7 Machine-room-less designs. Where machine-room-less designs are utilized they shall comply with the provisions of ASME A17.1 and incorporate the following:

1. Where the elevator car-top will be used as a work platform, it shall be equipped with permanently installed guards on all open sides. Guards shall be permitted to be of collapsible design, but otherwise must conform to all applicable requirements of this code for guards.

2. Where the equipment manufacturer's procedures for machinery removal and replacement depend on overhead structural support or lifting points, such supports or lifting points shall be permanently installed at the time of initial equipment installation.

3. Where the structure that the elevator will be located in is required to be fully sprinklered by this code, the hoistway that the elevator machine is located in shall be equipped with a fire suppression system as a machine room in accordance with NFPA 13. Smoke detectors for the automatic initiation of Phase I Emergency Recall Operation, and heat detectors or other approved devices that automatically disconnect the main line power supply to the elevators, shall be installed within the hoistway.

E. Change Section 3008.1 of the IBC to read:

3008.1 General. Where elevators in buildings greater than 420 feet (128 016 mm) in building height are to be used for occupant self-evacuation during fires, all passenger elevators for general public use shall comply with this section.

13VAC5-63-335. Special construction.

A. Change the title of IBC Section 3109 to read:

Swimming Pools, Swimming Pool Enclosures, and Aquatic Recreational Facilities.

B. Change Section 3109.1 of the IBC to read as follows: add Section 3109.1.1 to the IBC to read as follows and delete the remainder of Section 3109 of the IBC:

3109.1 General. Swimming pools, swimming pool enclosures, and aquatic recreational facilities, as that term is defined in the ISPSC, shall comply with applicable provisions of the ISPSC.

3109.1.1 Changes to the ISPSC. The following changes shall be made to the ISPSC:

1. Add Section 410.2 and related subsections to the ISPSC to read:

410.2 Showers. Showers shall be in accordance with Sections 410.2.1 through 410.2.5.

410.2.1 Deck hand shower or shower spray unit. Not less than one and not greater than half of the total number of showers required by Section 410.1 shall be a hand shower or spray shower unit located on the deck of or at the entrance of each pool.

410.2.2 Anti-scald device. Where heated water is provided to the showers, the shower water supply shall be controlled by an anti-scald device.

401.2.3 Water heater and mixing valve. Bather access to water heaters and thermostatically controlled mixing valves for showers shall be prohibited.

401.2.4 Flow rate. Each showerhead shall have a water flow of not less than 2 gallons per minute (7.6 lpm).

401.2.5 Temperature. At each showerhead, the heated shower water temperature shall not exceed 120°F (49°C) and shall not be less than 90°F (32°C).

2. Change the title of Section 609 of the ISPSC to read:

Dressing and Sanitary Facilities.

3. Change Section 609.3.1 of the ISPSC to read:

609.3.1 Deck hand shower or shower spray unit. Not less than one and not greater than half of the total number of showers required by Section 609.2 shall be a hand shower or shower spray unit located on the deck of or at the entrance of each pool.

13VAC5-63-350. Chapter 34 Existing structures.

A. ~~Change Section 3401.1 of the IBC to read: Delete Chapter 34 of the IBC in its entirety.~~

~~3401.1 Scope. The provisions of this chapter and the applicable requirements of Chapter 1 shall control the alteration, repair, addition and change of occupancy of existing structures.~~

B. ~~Delete IBC Sections 3401.2, 3401.3, 3401.4, and 3401.5.~~

C. ~~Delete IBC Sections 3403, 3404, 3405, and 3406.~~

D. ~~Change Section 3407.1 of the IBC to read:~~

~~3407.1 Standards for replacement glass. In accordance with § 36-99.2 of the Code of Virginia, any replacement glass installed in buildings constructed prior to the first edition of the USBC shall meet the quality and installation standards for glass installed in new buildings as are in effect at the time of installation. In addition, as a requirement of this code, the installation or replacement of glass in buildings constructed under any edition of the USBC shall be as required for new installations.~~

E. ~~Delete IBC Section 3408.~~

F. ~~Delete IBC Section 3410.~~

G. ~~Change Section 3412.2 of the IBC to read:~~

~~3412.2 Applicability. When specifically requested by an owner or an owner's agent in structures where there is~~

work involving additions, alterations or changes of occupancy, the provisions in Sections 3412.2.1 through 3412.2.5 shall apply to existing occupancies that will continue to be, or are proposed to be, in Groups A, B, E, F, M, R, S and U. These provisions shall not apply to buildings with occupancies in Group H or I.

H. Add an exception to Section 3412.2.1 of the IBC to read:

Exception: Plumbing, mechanical and electrical systems in buildings undergoing a change of occupancy shall be subject to any applicable requirements of Section 103.3 of this code.

I. Change Section 3412.2.5 of the IBC to read:

3412.2.5 Accessibility requirements. All portions of the buildings proposed for change of occupancy and all alterations to existing buildings shall conform to the applicable accessibility provisions of Section 3411.

J. Add IBC Section 3413 Retrofit Requirements.

K. Add Section 3413.1 to the IBC to read:

3413.1 Scope. In accordance with Section 103.7 and as setout herein, the following buildings are required to be provided with certain fire protection equipment or systems or other retrofitted components.

L. Add Section 3413.2 to the IBC to read:

3413.2 Smoke detectors in colleges and universities. In accordance with Section 36 99.3 of the Code of Virginia, college and university buildings containing dormitories for sleeping purposes shall be provided with battery powered or AC powered smoke detector devices installed therein in accordance with this code in effect on July 1, 1982. All public and private college and university dormitories shall have installed such detectors regardless of when the building was constructed. The chief administrative officer of the college or university shall obtain a certificate of compliance with the provisions of this subsection from the building official of the locality in which the college or university is located or in the case of state owned buildings, from the Director of the Virginia Department of General Services. The provisions of this section shall not apply to any dormitory at a state supported military college or university which is patrolled 24 hours a day by military guards.

M. Add Section 3413.3 to the IBC to read:

3413.3 Smoke detectors in certain juvenile care facilities. In accordance with § 36 99.4 of the Code of Virginia, battery powered or AC powered smoke detectors shall be installed in all local and regional detention homes, group homes, and other residential care facilities for children and juveniles which are operated by or under the auspices of the Virginia Department of Juvenile Justice, regardless of when the building was constructed, by July 1, 1986, in accordance with the provisions of this code that were in effect on July 1, 1984. Administrators of such homes and

facilities shall be responsible for the installation of the smoke detector devices.

N. Add Section 3413.4 to the IBC to read:

3413.4 Smoke detectors for the deaf and hearing impaired. In accordance with Section 36 99.5 of the Code of Virginia, smoke detectors providing an effective intensity of not less than 100 candela to warn a deaf or hearing-impaired individual shall be provided, upon request by the occupant to the landlord or proprietor, to any deaf or hearing impaired occupant of any of the following occupancies, regardless of when constructed:

1. All dormitory buildings arranged for the shelter and sleeping accommodations of more than 20 individuals;
2. All multiple family dwellings having more than two dwelling units, including all dormitories, boarding and lodging houses arranged for shelter and sleeping accommodations of more than five individuals; or
3. All buildings arranged for use of one family or two-family dwelling units.

A tenant shall be responsible for the maintenance and operation of the smoke detector in the tenant's unit.

A hotel or motel shall have available no fewer than one such smoke detector for each 70 units or portion thereof, except that this requirement shall not apply to any hotel or motel with fewer than 35 units. The proprietor of the hotel or motel shall post in a conspicuous place at the registration desk or counter a permanent sign stating the availability of smoke detectors for the hearing impaired. Visual detectors shall be provided for all meeting rooms for which an advance request has been made.

O. Add Sections 3413.5, 3413.5.1, and 3413.5.2 to the IBC to read:

3413.5 Assisted living facilities (formerly known as adult care residences or homes for adults). Existing assisted living facilities licensed by the Virginia Department of Social Services shall comply with this section.

3413.5.1 Fire protective signaling system and fire detection system. A fire protective signaling system and an automatic fire detection system meeting the requirements of the USBC, Volume I, 1987 Edition, Third Amendment, shall be installed in assisted living facilities by August 1, 1994.

Exception: Assisted living facilities that are equipped throughout with a fire protective signaling system and an automatic fire detection system.

3413.5.2 Single and multiple station smoke detectors. Battery or AC powered single and multiple station smoke detectors meeting the requirements of the USBC, Volume I, 1987 Edition, Third Amendment, shall be installed in assisted living facilities by August 1, 1994.

Regulations

~~Exception: Assisted living facilities that are equipped throughout with single and multiple station smoke detectors.~~

~~P. Add Section 3413.6 to the IBC to read:~~

~~3413.6 Smoke detectors in buildings containing dwelling units. AC powered smoke detectors with battery backup or an equivalent device shall be required to be installed to replace a defective or inoperative battery powered smoke detector located in buildings containing one or more dwelling units or rooming houses offering to rent overnight sleeping accommodations, when it is determined by the building official that the responsible party of such building or dwelling unit fails to maintain battery powered smoke detectors in working condition.~~

~~Q. Add Section 3413.7 to the IBC to read:~~

~~3413.7 Fire suppression, fire alarm and fire detection systems in nursing homes and facilities. Fire suppression systems as required by the edition of this code in effect on October 1, 1990, shall be installed in all nursing facilities licensed by the Virginia Department of Health by January 1, 1993, regardless of when such facilities or institutions were constructed. Units consisting of certified long term care beds located on the ground floor of general hospitals shall be exempt from the requirements of this section.~~

~~Fire alarm or fire detector systems, or both, as required by the edition of this code in effect on October 1, 1990, shall be installed in all nursing homes and nursing facilities licensed by the Virginia Department of Health by August 1, 1994.~~

~~R. Add Section 3413.8 to the IBC to read:~~

~~3413.8 Fire suppression systems in hospitals. Fire suppression systems shall be installed in all hospitals licensed by the Virginia Department of Health as required by the edition of this code in effect on October 1, 1995, regardless of when such facilities were constructed.~~

~~S. Add Section 3413.9 to the IBC to read:~~

~~3413.9 Identification of handicapped parking spaces by above grade signs. All parking spaces reserved for the use of handicapped persons shall be identified by above grade signs, regardless of whether identification of such spaces by above grade signs was required when any particular space was reserved for the use of handicapped persons. A sign or symbol painted or otherwise displayed on the pavement of a parking space shall not constitute an above grade sign. Any parking space not identified by an above grade sign shall not be a parking space reserved for the handicapped within the meaning of this section. All above grade handicapped parking space signs shall have the bottom edge of the sign no lower than four feet (1219 mm) nor higher than seven feet (2133 mm) above the parking surface. Such signs shall be designed and constructed in accordance with the provisions of Chapter 11 of this code. All disabled parking signs shall include the following~~

~~language: PENALTY, \$100-500 Fine, TOW AWAY ZONE. Such language may be placed on a separate sign and attached below existing above grade disabled parking signs, provided that the bottom edge of the attached sign is no lower than four feet above the parking surface.~~

~~T. Add Section 3413.10 to the IBC to read:~~

~~3413.10 Smoke detectors in hotels and motels. Smoke detectors shall be installed in hotels and motels as required by the edition of VR 394-01-22, USBC, Volume II, in effect on March 1, 1990, by the dates indicated, regardless of when constructed.~~

~~U. Add Section 3413.11 to the IBC to read:~~

~~3413.11 Sprinkler systems in hotel and motels. By September 1, 1997, an automatic sprinkler system shall be installed in hotels and motels as required by the edition of VR 394-01-22, USBC, Volume II, in effect on March 1, 1990, regardless of when constructed.~~

~~V. Add Section 3413.12 to the IBC to read:~~

~~3413.12 Fire suppression systems in dormitories. An automatic fire suppression system shall be provided throughout all buildings having a Group R-2 fire area which are more than 75 feet (22,860 mm) or six stories above the lowest level of exit discharge and which are used, in whole or in part, as a dormitory to house students by any public or private institution of higher education, regardless of when such buildings were constructed, in accordance with the edition of this code in effect on August 20, 1997, and the requirements for sprinkler systems under the edition of the NFPA 13 standard referenced by that code. The automatic fire suppression system shall be installed by September 1, 1999. The chief administrative office of the college or university shall obtain a certificate of compliance from the building official of the locality in which the college or university is located or in the case of state owned buildings, from the Director of the Virginia Department of General Services.~~

~~Exceptions:~~

~~1. Buildings equipped with an automatic fire suppression system in accordance with Section 903.3.1.1 or the 1983 or later editions of NFPA 13.~~

~~2. Any dormitory at a state supported military college or university which is patrolled 24 hours a day by military guards.~~

~~3. Application of the requirements of this section shall be modified in accordance with the following:~~

~~3.1. Building systems, equipment or components other than the fire suppression system shall not be required to be added or upgraded except as necessary for the installation of the fire suppression system and shall only be required to be added or upgraded where the installation of the fire suppression system creates an unsafe condition.~~

3.2. Residential sprinklers shall be used in all sleeping rooms. Other sprinklers shall be quick response or residential unless deemed unsuitable for a space. Standard response sprinklers shall be used in elevator hoist ways and machine rooms.

3.3. Sprinklers shall not be required in wardrobes in sleeping rooms that are considered part of the building construction or in closets in sleeping rooms, when such wardrobes or closets (i) do not exceed 24 square feet (2.23 m²) in area, (ii) have the smallest dimension less than 36 inches (914 mm), and (iii) comply with all of the following:

3.3.1. A single station smoke detector monitored by the building fire alarm system is installed in the room containing the wardrobe or closet that will activate the general alarm for the building if the single station smoke detector is not cleared within five minutes after activation.

3.3.2. The minimum number of sprinklers required for calculating the hydraulic demand of the system for the room shall be increased by two and the two additional sprinklers shall be corridor sprinklers where the wardrobe or closet is used to divide the room. Rooms divided by a wardrobe or closet shall be considered one room for the purpose of this requirement.

3.3.3. The ceiling of the wardrobe, closet or room shall have a fire resistance rating of not less than 1/2 hour.

3.4. Not more than one sprinkler shall be required in bathrooms within sleeping rooms or suites having a floor area between 55 square feet (5.12 m²) and 120 square feet (11.16 m²) provided the sprinkler is located to protect the lavatory area and the plumbing fixtures are of a noncombustible material.

3.5. Existing standpipe residual pressure shall be permitted to be reduced when the standpipe serves as the water supply for the fire suppression system provided the water supply requirements of NFPA 13-94 are met.

3.6. Limited service controllers shall be permitted for fire pumps when used in accordance with their listing.

3.7. Where a standby power system is required, a source of power in accordance with Section 701-11 (d) or 701-11 (e) of NFPA 70-96 shall be permitted.

W. Add Section 3413.13 to the IBC to read:

3413.13 Fire extinguishers and smoke detectors in SRCF's. SRCF's shall be provided with at least one approved type ABC portable fire extinguisher with a minimum rating of 2A10BC installed in each kitchen. In addition, SRCF's shall provide at least one approved and properly installed battery operated smoke detector outside of each sleeping area in the vicinity of bedrooms and bedroom hallways and on each additional floor.

X. Add Section 3413.14 to the IBC to read:

3413.14 Smoke detectors in adult day care centers. Battery powered or AC powered smoke detector devices shall be installed in all adult day care centers licensed by the Virginia Department of Social Services, regardless of when the building was constructed. The location and installation of the smoke detectors shall be determined by the provisions of this code in effect on October 1, 1990. The licensee shall obtain a certificate of compliance from the building official of the locality in which the center is located, or in the case of state owned buildings, from the Director of the Virginia Department of General Services.

Y. Add Section 3413.15 to the IBC to read:

3413.15 Posting of occupant load. Every room or space that is an assembly occupancy, and where the occupant load of that room or space is 50 or more, shall have the occupant load of the room or space as determined by the building official posted in a conspicuous place, near the main exit or exit access doorway from the room or space. Posted signs shall be of an approved legible permanent design and shall be maintained by the owner or authorized agent.

Z. Add Section 3413.16 to the IBC to read:

3413.16 ALFSTs. Existing ALFSTs, regardless of when constructed, shall by October 1, 2011, meet the applicable requirements of API 653 and TFI RMIP for suitability for service and inspections and shall provide a secondary containment system complying with Section 425.3.

13VAC5-63-360. Chapter 35 Referenced standards.

Change the referenced standards in Chapter 35 of the IBC as follows (standards not shown remain the same):

Standard reference number	Title	Referenced in code section number
ASTM E329-02	Standard Specification for Agencies Engaged in the Testing and/or Inspection of Materials Used in Construction	1703.1, 1703.1.3
API 650-09	Welded Steel Tanks for Oil Storage	425.2 <u>426.2</u>
API 653-09	Tank Inspection, Repair, Alteration and Reconstruction	425.4, 425.5, 3413.16 <u>426.4, 426.5</u>
ASME A17.1/CSA B44-2007 <u>ASME A17.1-2010/CSA B44-10</u>	Safety Code for Elevators and Escalators with 2008 and 2009 Addenda	907.3.3, 911.1.5, 1007.4, 1607.8.1, 1613.6.5, <u>1607.9.1</u> , 3001.2, 3001.4, 3002.5, 3003.2, 3007.1, 3008.3, <u>3008.12,</u>

Regulations

		3008.14.1, 3411.8.2 3007.2, 3008.2, 3008.2.1, 3008.7.6m, 3008.8.1
ASME A18.1- 2011	Safety Standard for Platform Lifts and Stairway Chairlifts	1109.8, 2702.2.6
NEPA 704.07	Identification of the Hazards of Materials for Emergency Response	425.2
ISPSC-12	International Swimming Pool and Spa Code	202, 3109.1, 3109.1.1
TFI RMIP-09	Aboveground Storage Tanks Containing Liquid Fertilizer, Recommended Mechanical Integrity Practices	425.2, 425.4, 425.5, 3413.16 426.2, 426.4, 426.5
UL 2034.08	Standard for Single and Multiple station Carbon Monoxide Alarms	908.7.1

13VAC5-63-390. Appendix I Patio covers.

The following provisions from Appendix I of the IBC are shall be part of this code:

H101 through H104 (Includes all provisions.)

Part II Rehabilitation

13VAC5-63-400. Chapter 1 Administration; Section 101 General.

A. Section 101.1 Short title. The Virginia Uniform Statewide Building Code, Part II, Rehabilitation, may be cited as the "Virginia Rehabilitation Code," or as the "VRC."

B. Section 101.2 Incorporation by reference. Chapters 2 - 16 of the 2009 2012 International Existing Building Code, published by the International Code Council, Inc., are adopted and incorporated by reference to be an enforceable part of the Virginia Rehabilitation Code VRC. The term "IEBC" means the 2009 2012 International Existing Building Code, published by the International Code Council, Inc. Any codes and standards referenced in the IEBC are also considered to be part of the incorporation by reference, except that such codes and standards are used only to the prescribed extent of each such reference.

C. Section 101.3 Numbering system. A dual numbering system is used in the Virginia Rehabilitation Code VRC to correlate the numbering system of the Virginia Administrative Code with the numbering system of the IEBC. IEBC numbering system designations are provided in the

catch-lines of the Virginia Administrative Code sections and cross references between sections or chapters of the Virginia Rehabilitation Code VRC use only the IEBC numbering system designations. The term "chapter" is used in the context of the numbering system of the IEBC and may mean a chapter in the Virginia Rehabilitation Code VRC, a chapter in the IEBC or a chapter in a referenced code or standard, depending on the context of the use of the term. The term "chapter" is not used to designate a chapter of the Virginia Administrative Code, unless clearly indicated.

D. Section 101.4 Arrangement of code provisions. The Virginia Rehabilitation Code VRC is comprised of the combination of (i) the provisions of Chapter 1, Administration, which are established herein, (ii) Chapters 2 - 16 of the IEBC, which are incorporated by reference in Section 101.2, and (iii) the changes to the text of the incorporated chapters of the IEBC that are specifically identified, including any new chapters added. The terminology "changes to the text of the incorporated chapters of the IEBC that are specifically identified, including any new chapters added" shall also be referred to as the "state amendments to the IEBC." Such state amendments to the IEBC are set out using corresponding chapter and section numbers of the IEBC numbering system. In addition, since Chapter 1 of the IEBC is not incorporated as part of the Virginia Rehabilitation Code VRC, any reference to a provision of Chapter 1 of the IEBC in the provisions of Chapters 2 - 16 of the IEBC is generally invalid. However, where the purpose of such a reference would clearly correspond to a provision of Chapter 1 established herein, then the reference may be construed to be a valid reference to such corresponding Chapter 1 provision.

E. Section 101.5 Use of terminology and notes. The term "this code," or "the code," where used in the provisions of Chapter 1, in Chapters 2 - 16 of the IEBC, or in the state amendments to the IEBC, means the Virginia Rehabilitation Code VRC, unless the context clearly indicates otherwise. The term "this code," or "the code," where used in a code or standard referenced in the IEBC, means that code or standard, unless the context clearly indicates otherwise. The term "USBC" where used in this code, means Part I of the Virginia Uniform Statewide Building Code, also known as the "Virginia Construction Code VCC," unless the context clearly indicates otherwise. In addition, where the phrase "of the International Building Code under which the building was constructed" is used in the IEBC, it shall be construed to mean the USBC or other code that was in effect when the building was built. Further, the use of notes in Chapter 1 is to provide information only and shall not be construed as changing the meaning of any code provision. Notes in the IEBC, in the codes and standards referenced in the IEBC and in the state amendments to the IEBC, may modify the content of a related provision and shall be considered to be a valid part of the provision, unless the context clearly indicates otherwise.

F. Section 101.6 Order of precedence. The provisions of this code shall be used as follows:

1. The provisions of Chapter 1 of this code supersede any conflicting provisions of Chapters 2 - 45 16 of the IEBC and that address the same subject matter and impose differing requirements.
2. The provisions of Chapter 1 of this code supersede any conflicting provisions of the codes and standards referenced in the IEBC that address the same subject matter and impose differing requirements. In addition, the
3. The state amendments to the IEBC supersede any conflicting provisions of Chapters 2 - 45 16 of the IEBC and that address the same subject matter and impose differing requirements.
4. The state amendments to the IEBC supersede any conflicting provisions of the codes and standards referenced in the IEBC that address the same subject matter and impose differing requirements. Further, the
5. The provisions of Chapters 2 - 45 16 of the IEBC supersede any conflicting provisions of the codes and standards referenced in the IEBC that address the same subject matter and impose differing requirements.

G. Section 101.7 Administrative provisions. The provisions of Chapter 1 establish administrative requirements, which include but are not limited to provisions relating to the scope and enforcement of the code. Any provisions of Chapters 2 - 45 16 of the IEBC or any provisions of the codes and standards referenced in the IEBC that address the same subject matter to a lesser or greater extent are deleted and replaced by the provisions of Chapter 1. Further, any administrative requirements contained in the state amendments to the IEBC shall be given the same precedence as the provisions of Chapter 1. Notwithstanding the above, where administrative requirements of Chapters 2 - 45 16 of the IEBC or of the codes and standards referenced in the IEBC are specifically identified as valid administrative requirements in Chapter 1 of this code or in the state amendments to the IEBC, then such requirements are not deleted and replaced.

Note: The purpose of this provision is to eliminate overlap, conflicts and duplication by providing a single standard for administrative, procedural and enforcement requirements of this code.

H. Section 101.8 Definitions. The definitions of terms used in this code are contained in Chapter 2 along with specific provisions addressing the use of definitions. Terms may be defined in other chapters or provisions of the code and such definitions are also valid.

13VAC5-63-410. Section 102 Purpose and scope.

A. Section 102.1 Purpose. In accordance with § 36-99.01 of the Code of Virginia, the General Assembly of Virginia has declared that (i) there is an urgent need to improve the housing conditions of low and moderate income individuals

and families, many of whom live in substandard housing, particularly in the older cities of the Commonwealth; (ii) there are large numbers of older residential buildings in the Commonwealth, both occupied and vacant, which are in urgent need of rehabilitation and must be rehabilitated if the state's citizens are to be housed in decent, sound, and sanitary conditions; and (iii) the application of those building code requirements currently in force to housing rehabilitation has sometimes led to the imposition of costly and time-consuming requirements that result in a significant reduction in the amount of rehabilitation activity taking place.

The General Assembly further declares that (i) there is an urgent need to improve the existing condition of many of the Commonwealth's stock of commercial properties, particularly in older cities; (ii) there are large numbers of older commercial buildings in the Commonwealth, both occupied and vacant, that are in urgent need of rehabilitation and that must be rehabilitated if the citizens of the Commonwealth are to be provided with decent, sound and sanitary work spaces; and (iii) the application of the existing building code to such rehabilitation has sometimes led to the imposition of costly and time-consuming requirements that result in a significant reduction in the amount of rehabilitation activity taking place.

B. Section 102.2 Scope. ~~In accordance with Section 103.6 of the USBC, this code shall be an acceptable alternative to compliance with the Virginia Construction Code for the rehabilitation of existing buildings and structures. The provisions of this code shall control the rehabilitation, reconstruction, alteration, repair, and change of occupancy of existing buildings and structures in occupancies other than Group R-5 and shall be permitted to be used as an alternative to compliance with the VCC for additions to buildings in any occupancy classification and for reconstruction, alteration or repair in Group R-5 occupancies.~~

Exception: The use of this code shall not be permitted for change of occupancy involving Group I-2 or I-3.

13VAC5-63-420. Section 103 Application of code.

A. Section 103.1 General. ~~The provisions of this code shall control the rehabilitation, alteration, repair, addition and change of occupancy of existing buildings and structures when this code is chosen as an alternative to compliance with the Virginia Construction Code. All administrative provisions of the Virginia Construction Code VCC, including but not limited to, requirements for permits, inspections and approvals by the local building department, provisions for appeals from decisions of the local building department and the issuance of modifications, are applicable to the use of this code, except where this code sets out differing requirements. Where there is a conflict between a general requirement and a specific requirement in the IEBC, the specific requirement shall govern.~~

Exception: the use of this code shall not be permitted for change of occupancy involving Group I-2 or Group I-3.

Regulations

B. Section 103.1.1 Use of performance code. Compliance with the provisions of a nationally recognized performance code when approved as a modification shall be considered to constitute compliance with this code. All documents submitted as part of such consideration shall be retained in the permanent records of the local building department.

C. Section 103.1.2 Preliminary meeting. When requested by a prospective permit applicant or when determined necessary by the code official, the code official shall meet with the prospective permit applicant prior to the application for a permit to discuss plans for the proposed work or change of occupancy in order to establish the specific applicability of the provisions of this code.

D. Section 103.2 Change of occupancy. No change of occupancy shall be made in any structure when the current USBC requires a greater degree of accessibility, structural strength, fire protection, means of egress, ventilation, or sanitation. When such a greater degree is required, the owner or the owner's agent shall make written application to the local building department for a new certificate of occupancy and shall obtain the new certificate of occupancy prior to the new use of the structure.

When impractical to achieve compliance with this code for the new occupancy classification, the building official shall consider modifications upon application and as provided for in Section 106.3 of the VCC.

E. Section 103.3 Retrofit requirements. In accordance with Section 103.7 of the VCC, the local building department shall enforce the provisions of Section 1701 that require certain existing buildings to be retrofitted with fire protection systems and other safety equipment. Retroactive fire protection system requirements contained in the IFC shall not be applicable unless required for compliance with the provisions of Section 1701.

F. Section 103.4 Nonrequired equipment. The following criteria for nonrequired equipment is in accordance with § 36-103 of the Code of Virginia. Building owners may elect to install partial or full fire alarms or other safety equipment that was not required by the edition of the VCC in effect at the time a building was constructed without meeting current requirements of the code, provided the installation does not create a hazardous condition. Permits for installation shall be obtained in accordance with the VCC. In addition, as a requirement of this code, when such nonrequired equipment is to be installed, the building official shall notify the appropriate fire official or fire chief.

G. Section 103.4.1 Reduction in function or discontinuance of nonrequired fire protection systems. When a nonrequired fire protection system is to be reduced in function or discontinued, it shall be done in such a manner so as not to create a false sense of protection. Generally, in such cases, any features visible from interior areas shall be removed, such as sprinkler heads, smoke detectors, or alarm panels or devices, but any wiring or piping hidden within the

construction of the building may remain. Approval of the proposed method of reduction or discontinuance shall be obtained from the building official.

H. Section 103.5 Equipment changes. Upon the replacement or new installation of any fuel-burning appliances or equipment in existing buildings, an inspection or inspections shall be conducted to ensure that the connected vent or chimney systems comply with the following:

1. Vent or chimney systems are sized in accordance with either the IRC, the IMC, or the IFGC, depending on which is applicable based on the fuel source and the occupancy classification of the structure.

2. Vent or chimney systems are clean, free of any obstruction or blockages, defects, or deterioration, and are in operable condition.

Where not inspected by the local building department, persons performing such changes or installations shall certify to the building official that the requirements of Items 1 and 2 of this section are met.

I. Section 103.6 Requirements relating to maintenance. Any requirements of the IEBC requiring the maintenance of existing buildings or structures are invalid.

Note: Requirements for the maintenance of existing buildings and structures and for unsafe conditions are contained in ~~Part III of the Virginia Uniform Statewide Building Code, also known as the "Virginia Maintenance Code VMC."~~

~~E. J. Section 403.3~~ 103.7 Use of Appendix A. Appendix A of the IEBC provides guidelines for the seismic retrofit of existing buildings. The use of this appendix is not mandatory but shall be permitted to be utilized at the option of an owner, the owner's agent or the RDP involved in a rehabilitation project. However, in no case shall the use of Appendix A be construed to authorize the lowering of existing levels of health or safety in buildings or structures being rehabilitated.

~~F. K. Section 403.4~~ 103.8 Use of Appendix B. Appendix B of the IEBC provides supplementary accessibility requirements for existing buildings and facilities. All applicable requirements of Appendix B shall be met in buildings and structures being rehabilitated.

~~G. L. Section 103.5~~ Use of Resource A. Resource A of the IEBC provides guidelines for the evaluation of fire resistance ratings of archaic materials and may be used in conjunction with rehabilitation projects.

13VAC5-63-430. Chapter 2 Definitions.

A. Change Section 201.3 of the IEBC to read:

201.3 Terms defined in other codes. Where terms are not defined in this code and are defined in the other International Codes, such terms shall have the meanings ascribed to them in those codes, except that terms that are not defined in this code and that are defined in the ~~Virginia~~

~~Construction Code~~ VCC shall take precedence over other definitions.

B. Change the following definition in Section 202 of the IEBC to read:

Existing building. A building for which a legal certificate of occupancy has been issued under any edition of the USBC and that has been occupied for its intended use; or, a building built prior to the initial edition of the USBC.

13VAC5-63-434. Chapter ~~7~~ 8 Alterations -- Level 2.

A. Change Exception 2 of Section ~~705.2~~ 805.2 to read:

2. Means of egress conforming to the requirements of the building code under which the building was constructed shall be considered compliant means of egress.

B. Change Item 7 of Section ~~705.3.1.1~~ 805.3.1.1 of the IEBC to read:

7. In ~~Group~~ Groups R-2, H-4, H-5 and I occupancies and in rooming houses and childcare centers, a single exit is permitted in a one-story building with a maximum occupant load of 10 and the exit access travel distance does not exceed 75 feet (22 860 mm). In dwelling units within Group R-2 buildings, an occupant load of 12 shall be permitted to be substituted for the occupant load established above and, in addition, staff of such family day homes shall not be counted for the purposes of establishing occupant loads.

13VAC5-63-438. Chapter ~~11~~ 12 Historic buildings.

Change Section ~~1101.2~~ 1201.2 of the IEBC to read:

~~1101.2~~ 1201.2 Report. The code official shall be permitted to require that an historic building undergoing repair, alteration or change of occupancy be investigated and evaluated by an RDP or other qualified person or agency as a condition of determining compliance with this code.

13VAC5-63-440. Chapter ~~13~~ 14 Performance compliance methods.

A. Change Section ~~1301.2~~ 1401.2 of the IEBC to read:

~~1301.2~~ 1401.2 Applicability. Work involving rehabilitation, additions, alterations or changes of occupancy shall be made to conform to the requirements of this chapter or the provisions of Chapters 4 ~~5~~ through ~~12~~ 13. The provisions in Sections ~~1301.2.1~~ 1401.2.1 through ~~1301.2.5~~ 1401.2.5 shall apply to existing occupancies that will continue to be, or are proposed to be, in Groups A, B, E, F, M, R, S and U. These provisions shall not apply to buildings with occupancies in Group H or I.

B. Add an exception to Section ~~1301.2.1~~ 1401.2.1 of the IEBC to read:

Exception: Plumbing, mechanical and electrical systems in buildings undergoing a change of occupancy shall be subject to any applicable requirements of ~~Section 103.3 of the Virginia Construction Code~~ Chapter 10.

C. Change Section ~~1301.2.5~~ 1401.2.5 of the IEBC to read:

~~1301.2.5~~ 1401.2.5 Accessibility requirements. All portions of the buildings proposed for change of occupancy and all alterations to existing buildings shall conform to the applicable accessibility provisions of Section ~~340~~ 410.

13VAC5-63-445. Chapter 17 Retrofit requirements.

A. Add IEBC Section 1701 General.

B. Add Section 1701.1 to the IEBC to read:

1701.1 Scope. In accordance with Section 103.7 of the VCC and as set out herein, the following buildings are required to be provided with certain fire protection equipment or systems or other retrofitted components.

C. Add Section 1701.2 to the IEBC to read:

1701.2 Smoke detectors in colleges and universities. In accordance with § 36-99.3 of the Code of Virginia, college and university buildings containing dormitories for sleeping purposes shall be provided with battery-powered or AC-powered smoke detector devices installed therein in accordance with this code in effect on July 1, 1982. All public and private college and university dormitories shall have installed such detectors regardless of when the building was constructed. The chief administrative office of the college or university shall obtain a certificate of compliance with the provisions of this subsection from the building official of the locality in which the college or university is located or, in the case of state-owned buildings, from the Director of the Virginia Department of General Services. The provisions of this section shall not apply to any dormitory at a state-supported military college or university that is patrolled 24 hours a day by military guards.

D. Add Section 1701.3 to the IEBC to read:

1701.3 Smoke detectors in certain juvenile care facilities. In accordance with § 36-99.4 of the Code of Virginia, battery-powered or AC-powered smoke detectors shall be installed in all local and regional detention homes, group homes, and other residential care facilities for children and juveniles that are operated by or under the auspices of the Virginia Department of Juvenile Justice, regardless of when the building was constructed, by July 1, 1986, in accordance with the provisions of this code that were in effect on July 1, 1984. Administrators of such homes and facilities shall be responsible for the installation of the smoke detector devices.

E. Add Section 1701.4 to the IEBC to read:

1701.4 Smoke detectors for the deaf and hearing-impaired. In accordance with § 36-99.5 of the Code of Virginia, smoke detectors providing an effective intensity of not less than 100 candela to warn a deaf or hearing-impaired individual shall be provided, upon request by the occupant to the landlord or proprietor, to any deaf or hearing-impaired occupant of any of the following occupancies, regardless of when constructed:

Regulations

1. All dormitory buildings arranged for the shelter and sleeping accommodations of more than 20 individuals;
2. All multiple-family dwellings having more than two dwelling units, including all dormitories and boarding and lodging houses arranged for shelter and sleeping accommodations of more than 5 individuals; or
3. All buildings arranged for use as one-family or two-family dwelling units.

A tenant shall be responsible for the maintenance and operation of the smoke detector in the tenant's unit.

A hotel or motel shall have available no fewer than one such smoke detector for each 70 units or portion thereof, except that this requirement shall not apply to any hotel or motel with fewer than 35 units. The proprietor of the hotel or motel shall post in a conspicuous place at the registration desk or counter a permanent sign stating the availability of smoke detectors for the hearing impaired. Visual detectors shall be provided for all meeting rooms for which an advance request has been made.

F. Add Sections 1701.5, 1701.5.1, and 1701.5.2 to the IEBC to read:

1701.5 Assisted living facilities (formerly known as adult care residences or homes for adults). Existing assisted living facilities licensed by the Virginia Department of Social Services shall comply with this section.

1701.5.1 Fire protective signaling system and fire detection system. A fire protective signaling system and an automatic fire detection system meeting the requirements of the USBC, Volume I, 1987 Edition, Third Amendment, shall be installed in assisted living facilities by August 1, 1994.

Exception: Assisted living facilities that are equipped throughout with a fire protective signaling system and an automatic fire detection system.

1701.5.2 Single-station and multiple-station smoke detectors. Battery or AC-powered single-station and multiple-station smoke detectors meeting the requirements of the USBC, Volume I, 1987 Edition, Third Amendment, shall be installed in assisted living facilities by August 1, 1994.

Exception: Assisted living facilities that are equipped throughout with single-station and multiple-station smoke detectors.

G. Add Section 1701.6 to the IEBC to read:

1701.6 Smoke detectors in buildings containing dwelling units. AC-powered smoke detectors with battery backup or an equivalent device shall be required to be installed to replace a defective or inoperative battery-powered smoke detector located in buildings containing one or more dwelling units or rooming houses offering to rent overnight sleeping accommodations when it is determined by the building official that the responsible party of such building

or dwelling unit fails to maintain battery-powered smoke detectors in working condition.

H. Add Section 1701.7 to the IEBC to read:

1701.7 Fire suppression, fire alarm, and fire detection systems in nursing homes and facilities. Fire suppression systems as required by the edition of this code in effect on October 1, 1990, shall be installed in all nursing facilities licensed by the Virginia Department of Health by January 1, 1993, regardless of when such facilities or institutions were constructed. Units consisting of certified long-term care beds located on the ground floor of general hospitals shall be exempt from the requirements of this section.

Fire alarm or fire detector systems, or both, as required by the edition of this code in effect on October 1, 1990, shall be installed in all nursing homes and nursing facilities licensed by the Virginia Department of Health by August 1, 1994.

I. Add Section 1701.8 to the IEBC to read:

1701.8 Fire suppression systems in hospitals. Fire suppression systems shall be installed in all hospitals licensed by the Virginia Department of Health as required by the edition of this code in effect on October 1, 1995, regardless of when such facilities were constructed.

J. Add Section 1701.9 to the IEBC to read:

1701.9 Identification of disabled parking spaces by above grade signage. All parking spaces reserved for the use of persons with disabilities shall be identified by above grade signs, regardless of whether identification of such spaces by above grade signs was required when any particular space was reserved for the use of persons with disabilities. A sign or symbol painted or otherwise displayed on the pavement of a parking space shall not constitute an above grade sign. Any parking space not identified by an above grade sign shall not be a parking space reserved for the disabled within the meaning of this section. All above grade disabled parking space signs shall have the bottom edge of the sign no lower than 4 feet (1219 mm) nor higher than 7 feet (2133 mm) above the parking surface. Such signs shall be designed and constructed in accordance with the provisions of Chapter 11 of this code. All disabled parking signs shall include the following language: "PENALTY, \$100-500 Fine, TOW-AWAY ZONE." Such language may be placed on a separate sign and attached below existing above grade disabled parking signs, provided that the bottom edge of the attached sign is no lower than 4 feet above the parking surface.

K. Add Section 1701.10 to the IEBC to read:

1701.10 Smoke detectors in hotels and motels. Smoke detectors shall be installed in hotels and motels as required by the edition of VR 394-01-22, USBC, Volume II, in effect on March 1, 1990, by the dates indicated, regardless of when constructed.

L. Add Section 1701.11 to the IEBC to read:

1701.11 Sprinkler systems in hotel and motels. By September 1, 1997, an automatic sprinkler system shall be installed in hotels and motels as required by the edition of VR 394-01-22, USBC, Volume II, in effect on March 1, 1990, regardless of when constructed.

M. Add Section 1701.12 to the IEBC to read:

1701.12 Fire suppression systems in dormitories. An automatic fire suppression system shall be provided throughout all buildings having a Group R-2 fire area that are more than 75 feet (22,860 mm) or 6 stories above the lowest level of exit discharge and are used, in whole or in part, as a dormitory to house students by any public or private institution of higher education, regardless of when such buildings were constructed, in accordance with the edition of this code in effect on August 20, 1997, and the requirements for sprinkler systems under the edition of the NFPA 13 standard referenced by that code. The automatic fire suppression system shall be installed by September 1, 1999. The chief administrative office of the college or university shall obtain a certificate of compliance from the building official of the locality in which the college or university is located or, in the case of state-owned buildings, from the Director of the Virginia Department of General Services.

Exceptions:

1. Buildings equipped with an automatic fire suppression system in accordance with Section 903.3.1.1 of the 1983 or later editions of NFPA 13.

2. Any dormitory at a state-supported military college or university that is patrolled 24 hours a day by military guards.

3. Application of the requirements of this section shall be modified in accordance with the following:

3.1. Building systems, equipment, or components other than the fire suppression system shall not be required to be added or upgraded except as necessary for the installation of the fire suppression system and shall only be required to be added or upgraded where the installation of the fire suppression system creates an unsafe condition.

3.2. Residential sprinklers shall be used in all sleeping rooms. Other sprinklers shall be quick response or residential unless deemed unsuitable for a space. Standard response sprinklers shall be used in elevator hoistways and machine rooms.

3.3. Sprinklers shall not be required in wardrobes in sleeping rooms that are considered part of the building construction or in closets in sleeping rooms when such wardrobes or closets (i) do not exceed 24 square feet (2.23 m²) in area, (ii) have the smallest dimension less than 36 inches (914 mm), and (iii) comply with all of the following:

3.3.1. A single-station smoke detector monitored by the building fire alarm system is installed in the room containing the wardrobe or closet that will activate the general alarm for the building if the single station smoke detector is not cleared within five minutes after activation.

3.3.2. The minimum number of sprinklers required for calculating the hydraulic demand of the system for the room shall be increased by two and the two additional sprinklers shall be corridor sprinklers where the wardrobe or closet is used to divide the room. Rooms divided by a wardrobe or closet shall be considered one room for the purpose of this requirement.

3.3.3. The ceiling of the wardrobe, closet, or room shall have a fire resistance rating of not less than 1/2 hour.

3.4. Not more than one sprinkler shall be required in bathrooms within sleeping rooms or suites having a floor area between 55 square feet (5.12 m²) and 120 square feet (11.16 m²), provided the sprinkler is located to protect the lavatory area and the plumbing fixtures are of a noncombustible material.

3.5. Existing standpipe residual pressure shall be permitted to be reduced when the standpipe serves as the water supply for the fire suppression system, provided the water supply requirements of NFPA 13-94 are met.

3.6. Limited service controllers shall be permitted for fire pumps when used in accordance with their listing.

3.7. Where a standby power system is required, a source of power in accordance with Section 701-11 (d) or 701-11 (e) of NFPA 70-96 shall be permitted.

N. Add Section 1701.13 to the IEBC to read:

1701.13 Fire extinguishers and smoke detectors in SRCFs. SRCFs shall be provided with at least one approved type ABC portable fire extinguisher with a minimum rating of 2A10BC installed in each kitchen. In addition, SRCFs shall provide at least one approved and properly installed battery operated smoke detector outside of each sleeping area in the vicinity of bedrooms and bedroom hallways and on each additional floor.

O. Add Section 1701.14 to the IEBC to read:

1701.14 Smoke detectors in adult day care centers. Battery-powered or AC-powered smoke detector devices shall be installed in all adult day care centers licensed by the Virginia Department of Social Services, regardless of when the building was constructed. The location and installation of the smoke detectors shall be determined by the provisions of this code in effect on October 1, 1990. The licensee shall obtain a certificate of compliance from the building official of the locality in which the center is located or, in the case of state-owned buildings, from the Director of the Virginia Department of General Services.

P. Add Section 1701.15 to the IEBC to read:

Regulations

1701.15 Posting of occupant load. Every room or space that is an assembly occupancy, and where the occupant load of that room or space is 50 or more, shall have the occupant load of the room or space as determined by the building official posted in a conspicuous place, near the main exit or exit access doorway from the room or space. Posted signs shall be of an approved legible permanent design and shall be maintained by the owner or owner's authorized agent.

Q. Add Section 1701.16 to the IEBC to read:

1701.16 ALFSTs. Existing ALFSTs, regardless of when constructed, shall by October 1, 2011, meet the applicable requirements of API 653 and TFI RMIP for suitability for service and inspections and shall provide a secondary containment system complying with Section 425.3 of the VCC.

R. Add Section 1701.17 to the IEBC to read:

1701.17 Standards for replacement glass. In accordance with § 36-99.2 of the Code of Virginia, any replacement glass installed in buildings constructed prior to the first edition of the USBC shall meet the quality and installation standards for glass installed in new buildings as are in effect at the time of installation. In addition, as a requirement of this code, the installation or replacement of glass in buildings constructed under any edition of the USBC shall be as required for new installations.

Part III
Maintenance

13VAC5-63-450. Chapter 1 Administration; Section 101 General.

A. Section 101.1 Short title. The Virginia Uniform Statewide Building Code, Part III, Maintenance, may be cited as the "Virginia Maintenance Code," or as the "VMC."

B. Section 101.2 Incorporation by reference. Chapters 2 - 8 of the ~~2009~~ 2012 International Property Maintenance Code, published by the International Code Council, Inc., are adopted and incorporated by reference to be an enforceable part of the ~~Virginia Maintenance Code VMC~~. The term "IPMC" means the ~~2009~~ 2012 International Property Maintenance Code, published by the International Code Council, Inc. Any codes and standards referenced in the IPMC are also considered to be part of the incorporation by reference, except that such codes and standards are used only to the prescribed extent of each such reference.

C. Section 101.3 Numbering system. A dual numbering system is used in the ~~Virginia Maintenance Code VMC~~ to correlate the numbering system of the Virginia Administrative Code with the numbering system of the IPMC. IPMC numbering system designations are provided in the catch-lines of the ~~Virginia Administrative Code VMC~~ sections and cross references between sections or chapters of the Virginia Maintenance Code use only the IPMC numbering system designations. The term "chapter" is used in

the context of the numbering system of the IPMC and may mean a chapter in the ~~Virginia Maintenance Code VMC~~, a chapter in the IPMC or a chapter in a referenced code or standard, depending on the context of the use of the term. The term "chapter" is not used to designate a chapter of the Virginia Administrative Code, unless clearly indicated.

D. Section 101.4 Arrangement of code provisions. The ~~Virginia Maintenance Code VMC~~ is comprised of the combination of (i) the provisions of Chapter 1, Administration, which are established herein, (ii) Chapters 2 - 8 of the IPMC, which are incorporated by reference in Section 101.2, and (iii) the changes to the text of the incorporated chapters of the IPMC which are specifically identified. The terminology "changes to the text of the incorporated chapters of the IPMC which are specifically identified" shall also be referred to as the "state amendments to the IPMC." Such state amendments to the IPMC are set out using corresponding chapter and section numbers of the IPMC numbering system. In addition, since Chapter 1 of the IPMC is not incorporated as part of the ~~Virginia Maintenance Code VMC~~, any reference to a provision of Chapter 1 of the IPMC in the provisions of Chapters 2 - 8 of the IPMC is generally invalid. However, where the purpose of such a reference would clearly correspond to a provision of Chapter 1 established herein, then the reference may be construed to be a valid reference to such corresponding Chapter 1 provision.

E. Section 101.5 Use of terminology and notes. The term "this code," or "the code," where used in the provisions of Chapter 1, in Chapters 2 - 8 of the IPMC₁ or in the state amendments to the IPMC₂ means the ~~Virginia Maintenance Code VMC~~, unless the context clearly indicates otherwise. The term "this code," or "the code," where used in a code or standard referenced in the IPMC₂ means that code or standard, unless the context clearly indicates otherwise. The term "USBC" where used in this code means ~~Part I of the Virginia Uniform Statewide Building Code, also known as the "Virginia Construction Code," VCC~~ unless the context clearly indicates otherwise. In addition, the use of notes in Chapter 1 is to provide information only and shall not be construed as changing the meaning of any code provision. Notes in the IPMC₂ and in the state amendments to the IPMC₂ may modify the content of a related provision and shall be considered to be a valid part of the provision, unless the context clearly indicates otherwise.

F. Section 101.6 Order of precedence. The provisions of this code shall be used as follows:

1. The provisions of Chapter 1 of this code supersede any conflicting provisions of Chapters 2 - 8 of the IPMC and that address the same subject matter and impose differing requirements.

2. The provisions of Chapter 1 of this code supersede any conflicting provisions of the codes and standards

referenced in the IPMC that address the same subject matter and impose differing requirements. ~~In addition, the~~

~~3. The state amendments to the IPMC supersede any conflicting provisions of Chapters 2 - 8 of the IPMC and that address the same subject matter and impose differing requirements.~~

~~4. The state amendments to the IPMC supersede any conflicting provisions of the codes and standards referenced in the IPMC that address the same subject matter and impose differing requirements. Further, the~~

~~5. The provisions of Chapters 2 - 8 of the IPMC supersede any conflicting provisions of the codes and standards referenced in the IPMC that address the same subject matter and impose differing requirements.~~

G. Section 101.7 Administrative provisions. The provisions of Chapter 1 establish administrative requirements, which include but are not limited to provisions relating to the scope of the code, enforcement, fees, permits, inspections and disputes. Any provisions of Chapters 2 - 8 of the IPMC or any provisions of the codes and standards referenced in the IPMC which address the same subject matter to a lesser or greater extent are deleted and replaced by the provisions of Chapter 1. Further, any administrative requirements contained in the state amendments to the IPMC shall be given the same precedence as the provisions of Chapter 1. Notwithstanding the above, where administrative requirements of Chapters 2 - 8 of the IPMC or of the codes and standards referenced in the IPMC are specifically identified as valid administrative requirements in Chapter 1 of this code or in the state amendments to the IPMC, then such requirements are not deleted and replaced.

Note: The purpose of this provision is to eliminate overlap, conflicts and duplication by providing a single standard for administrative, procedural and enforcement requirements of this code.

H. Section 101.8 Definitions. The definitions of terms used in this code are contained in Chapter 2 along with specific provisions addressing the use of definitions. Terms may be defined in other chapters or provisions of the code and such definitions are also valid.

Note: The order of precedence outlined in Section 101.6 may be determinative in establishing how to apply the definitions in the IPMC and in the referenced codes and standards.

13VAC5-63-460. Section 102 Purpose and scope.

A. Section 102.1 Purpose. In accordance with § 36-103 of the Code of Virginia, the Virginia Board of Housing and Community Development may adopt and promulgate as part of the Virginia Uniform Statewide Building Code, building regulations that facilitate the maintenance, rehabilitation, development and reuse of existing buildings at the least possible cost to ensure the protection of the public health, safety and welfare. Further, in accordance with § 36-99 of the

Code of Virginia, the purpose of this code is to protect the health, safety and welfare of the residents of the Commonwealth of Virginia, provided that buildings and structures should be permitted to be maintained at the least possible cost consistent with recognized standards of health, safety, energy conservation and water conservation, including provisions necessary to prevent overcrowding, rodent or insect infestation, and garbage accumulation; and barrier-free provisions for the physically handicapped and aged.

B. Section 102.2 Scope. In accordance with § 36-98 of the Code of Virginia, the ~~Virginia Maintenance Code VMC~~ shall supersede the building codes and regulations of the counties, municipalities and other political subdivisions and state agencies.

C. Section 102.3 Exemptions. This code shall not regulate those buildings and structures specifically exempt from the ~~Virginia Construction Code VCC~~, except that existing industrialized buildings and manufactured homes shall not be exempt from this code.

13VAC5-63-470. Section 103 Application of code.

A. Section 103.1 General. This code prescribes regulations for the maintenance of all existing buildings and structures and associated equipment, including regulations for unsafe buildings and structures.

B. Section 103.2 Maintenance requirements. Buildings and structures shall be maintained and kept in good repair in accordance with the requirements of this code and when applicable in accordance with the USBC under which such building or structure was constructed. No provision of this code shall require alterations to be made to an existing building or structure or to equipment unless conditions are present which meet the definition of an unsafe structure or a structure unfit for human occupancy.

C. 103.2.1 Maintenance of nonrequired fire protection systems. Nonrequired fire protection systems shall be maintained to function as originally installed. If any such systems are to be reduced in function or discontinued, approval shall be obtained from the building official in accordance with Section 103.8.1 of the ~~Virginia Construction Code VCC~~.

D. Section 103.3 Continued approval. Notwithstanding any provision of this code to the contrary, alterations shall not be required to be made to existing buildings or structures which are occupied in accordance with a certificate of occupancy issued under any edition of the USBC.

E. Section 103.4 Rental Inspections. In accordance with § 36-105.1:1 of the Code of Virginia, these provisions are applicable to rental inspection programs. For purposes of this section:

"Dwelling unit" means a building or structure or part thereof that is used for a home or residence by one or more persons who maintain a household.

Regulations

"Owner" means the person shown on the current real estate assessment books or current real estate assessment records.

"Residential rental dwelling unit" means a dwelling unit that is leased or rented to one or more tenants. However, a dwelling unit occupied in part by the owner thereof shall not be construed to be a residential rental dwelling unit unless a tenant occupies a part of the dwelling unit that has its own cooking and sleeping areas, and a bathroom, unless otherwise provided in the zoning ordinance by the local governing body.

The local governing body may adopt an ordinance to inspect residential rental dwelling units for compliance with this code and to promote safe, decent and sanitary housing for its citizens, in accordance with the following:

1. Except as provided for in subdivision 3 of this subsection, the dwelling units shall be located in a rental inspection district established by the local governing body in accordance with this section; and
2. The rental inspection district is based upon a finding by the local governing body that (i) there is a need to protect the public health, safety and welfare of the occupants of dwelling units inside the designated rental inspection district; (ii) the residential rental dwelling units within the designated rental inspection district are either (a) blighted or in the process of deteriorating or (b) the residential rental dwelling units are in the need of inspection by the building department to prevent deterioration, taking into account the number, age and condition of residential dwelling rental units inside the proposed rental inspection district; and (iii) the inspection of residential rental dwelling units inside the proposed rental inspection district is necessary to maintain safe, decent and sanitary living conditions for tenants and other residents living in the proposed rental inspection district. Nothing in this section shall be construed to authorize a one or more locality-wide rental inspection ~~district~~ districts and a local governing body shall limit the boundaries of the proposed rental inspection ~~district~~ districts to such areas of the locality that meet the criteria set out in this subsection; or
3. An individual residential rental dwelling unit outside of a designated rental inspection district is made subject to the rental inspection ordinance based upon a separate finding for each individual dwelling unit by the local governing body that (i) there is a need to protect the public health, welfare and safety of the occupants of that individual dwelling unit; (ii) the individual dwelling unit is either (a) blighted or (b) in the process of deteriorating; or (iii) there is evidence of violations of this code that affect the safe, decent and sanitary living conditions for tenants living in such individual dwelling unit.

For purposes of this section, the local governing body may designate a local government agency other than the building department to perform all or part of the duties contained in

the enforcement authority granted to the building department by this section.

Before adopting a rental inspection ordinance and establishing a rental inspection district or an amendment to either, the governing body of the locality shall hold a public hearing on the proposed ordinance. Notice of the hearing shall be published once a week for two successive weeks in a newspaper published or having general circulation in the locality.

Upon adoption by the local governing body of a rental inspection ordinance, the building department shall make reasonable efforts to notify owners of residential rental dwelling units in the designated rental inspection district, or their designated managing agents, and to any individual dwelling units subject to the rental inspection ordinance, not located in a rental inspection district, of the adoption of such ordinance, and provide information and an explanation of the rental inspection ordinance and the responsibilities of the owner thereunder.

The rental inspection ordinance may include a provision that requires the owners of dwelling units in a rental inspection district to notify the building department in writing if the dwelling unit of the owner is used for residential rental purposes. The building department may develop a form for such purposes. The rental inspection ordinance shall not include a registration requirement or a fee of any kind associated with the written notification pursuant to this subdivision. A rental inspection ordinance may not require that the written notification from the owner of a dwelling unit subject to a rental inspection ordinance be provided to the building department in less than 60 days after the adoption of a rental inspection ordinance. However, there shall be no penalty for the failure of an owner of a residential rental dwelling unit to comply with the provisions of this subsection, unless and until the building department provides personal or written notice to the property owner, as provided in this section. In any event, the sole penalty for the willful failure of an owner of a dwelling unit who is using the dwelling unit for residential rental purposes to comply with the written notification requirement shall be a civil penalty of up to \$50. For purposes of this subsection, notice sent by regular first-class mail to the last known address of the owner as shown on the current real estate tax assessment books or current real estate tax assessment records shall be deemed compliance with this requirement.

Upon establishment of a rental inspection district in accordance with this section, the building department may, in conjunction with the written notifications as provided for above, proceed to inspect dwelling units in the designated rental inspection district to determine if the dwelling units are being used as a residential rental property and for compliance with the provisions of this code that affect the safe, decent and sanitary living conditions for the tenants of such property.

If a multifamily development has more than 10 dwelling units, in the initial and periodic inspections, the building department shall inspect only a sampling of dwelling units, of not less than two and not more than 10% of the dwelling units, of a multifamily development, that includes all of the multifamily buildings that are part of that multifamily development. In no event, however, shall the building department charge a fee authorized by this section for inspection of more than 10 dwelling units. If the building department determines upon inspection of the sampling of dwelling units that there are violations of this code that affect the safe, decent and sanitary living conditions for the tenants of such multifamily development, the building department may inspect as many dwelling units as necessary to enforce these provisions, in which case, the fee shall be based upon a charge per dwelling unit inspected, as otherwise provided in the fee schedule established pursuant to this section.

Upon the initial or periodic inspection of a residential rental dwelling unit subject to a rental inspection ordinance, the building department has the authority under these provisions to require the owner of the dwelling unit to submit to such follow-up inspections of the dwelling unit as the building department deems necessary, until such time as the dwelling unit is brought into compliance with the provisions of this code that affect the safe, decent and sanitary living conditions for the tenants.

Except as provided for above, following the initial inspection of a residential rental dwelling unit subject to a rental inspection ordinance, the building department may inspect any residential rental dwelling unit in a rental inspection district, that is not otherwise exempted in accordance with this section, no more than once each calendar year.

Upon the initial or periodic inspection of a residential rental dwelling unit subject to a rental inspection ordinance for compliance with these provisions, provided that there are no violations of this code that affect the safe, decent and sanitary living conditions for the tenants of such residential rental dwelling unit, the building department shall provide, to the owner of such residential rental dwelling unit, an exemption from the rental inspection ordinance for a minimum of four years. Upon the sale of a residential rental dwelling unit, the building department may perform a periodic inspection as provided above, subsequent to such sale. If a residential rental dwelling unit has been issued a certificate of occupancy within the last four years, an exemption shall be granted for a minimum period of four years from the date of the issuance of the certificate of occupancy by the building department. If the residential rental dwelling unit becomes in violation of this code during the exemption period, the building department may revoke the exemption previously granted under this section.

A local governing body may establish a fee schedule for enforcement of these provisions, which includes a per

dwelling unit fee for the initial inspections, follow-up inspections and periodic inspections under this section.

The provisions of this section shall not in any way alter the rights and obligations of landlords and tenants pursuant to the applicable provisions of Chapter 13 (§ 55-217 et seq.) or Chapter 13.2 (§ 55-248.2 et seq.) of Title 55 of the Code of Virginia.

The provisions of this section shall not alter the duties or responsibilities of the local building department under § 36-105 of the Code of Virginia to enforce the USBC.

Unless otherwise provided for in § 36-105.1:1 of the Code of Virginia, penalties for violation of this section shall be the same as the penalties provided for violations of other sections of the USBC.

13VAC5-63-480. Section 104 Enforcement, generally.

A. Section 104.1 Scope of enforcement. This section establishes the requirements for enforcement of this code in accordance with § 36-105 of the Code of Virginia. The local governing body may also inspect and enforce the provisions of the USBC for existing buildings and structures, whether occupied or not. Such inspection and enforcement shall be carried out by an agency or department designated by the local governing body.

If the local building department receives a complaint that a violation of this code exists that is an immediate and imminent threat to the health or safety of the owner ~~or~~ tenant, or occupants of a residential dwelling unit any building or structure, or a the owner, occupant, or tenant of any nearby residential dwelling unit building or structure, and the owner, occupant, or tenant of the residential dwelling unit building or structure that is the subject of the complaint has refused to allow the code official or his agent to have access to the subject dwelling building or structure, the code official or his agent may present sworn testimony to a magistrate or court of competent jurisdiction and request that the magistrate or court grant the code official or his agent an inspection warrant to enable the code official or his agent to enter the subject dwelling building or structure for the purpose of determining whether violations of this code exist. The code official or his agent shall make a reasonable effort to obtain consent from the owner, occupant, or tenant of the subject dwelling building or structure prior to seeking the issuance of an inspection warrant under this section.

Note: Generally, official action must be taken by the local government to enforce the ~~Virginia Maintenance Code VMC.~~ Consultation with the legal counsel of the jurisdiction when initiating or changing such action is advised.

B. Section 104.1.1 Transfer of ownership. In accordance with § 36-105 of the Code of Virginia, if the local building department has initiated an enforcement action against the owner of a building or structure and such owner subsequently transfers the ownership of the building or structure to an entity in which the owner holds an ownership interest greater

Regulations

than 50%, the pending enforcement action shall continue to be enforced against the owner.

C. Section 104.2 Fees. In accordance with § 36-105 of the Code of Virginia, fees may be levied by the local governing body in order to defray the cost of enforcement and appeals.

D. Section 104.3 State buildings. In accordance with § 36-98.1 of the Code of Virginia, this code shall be applicable to state-owned buildings and structures. Acting through the Division of Engineering and Buildings, the Department of General Services shall function as the building official for state-owned buildings.

E. Section 104.3.1 Certification of state enforcement personnel. State enforcement personnel shall comply with the applicable requirements of Sections 104.4.2 through 104.4.4 for certification, periodic maintenance training, and continuing education.

F. Section 104.4 Local enforcing agency. In jurisdictions enforcing this code, the local governing body shall designate the agency within the local government responsible for such enforcement and appoint a code official. The local governing body may also utilize technical assistants to assist the code official in the enforcement of this code. A permanently appointed code official shall not be removed from office except for cause after having been afforded a full opportunity to be heard on specific and relevant charges by and before the appointing authority. DHCD shall be notified by the appointing authority within 30 days of the appointment or release of a permanent or acting code official and within 60 days after retaining or terminating a technical assistant.

Note: Code officials and technical assistants are subject to sanctions in accordance with the VCS.

G. Section 104.4.1 Qualifications of code official and technical assistants. The code official shall have at least five years of building experience as a licensed professional engineer or architect, building, fire or trade inspector, contractor, housing inspector or superintendent of building, fire or trade construction or at ~~least~~ least five years of building experience after obtaining a degree in architecture or engineering, with at least three years in responsible charge of work. Any combination of education and experience that would confer equivalent knowledge and ability shall be deemed to satisfy this requirement. The code official shall have general knowledge of sound engineering practice in respect to the design and construction of structures, the basic principles of fire prevention, the accepted requirements for means of egress and the installation of elevators and other service equipment necessary for the health, safety and general welfare of the occupants and the public. The local governing body may establish additional qualification requirements.

A technical assistant shall have at least three years of experience and general knowledge in at least one of the following areas: building construction, building, fire or housing inspections, plumbing, electrical or mechanical trades, fire protection, elevators or property maintenance

work. Any combination of education and experience which would confer equivalent knowledge and ability shall be deemed to satisfy this requirement. The locality may establish additional certification requirements.

H. Section 104.4.2 Certification of code official and technical assistants. An acting or permanent code official shall be certified as a code official in accordance with the VCS within one year after being appointed as acting or permanent code official. A technical assistant shall be certified in the appropriate subject area within 18 months after becoming a technical assistant. When required by a locality to have two or more certifications, a technical assistant shall obtain the additional certifications within three years from the date of such requirement.

Exception: A code official or technical assistant in place prior to April 1, 1995, shall not be required to meet the certification requirements in this section while continuing to serve in the same capacity in the same locality.

I. Section 104.4.3 Noncertified code official. Except for a code official exempt from certification under the exception to Section 104.4.2, any acting or permanent code official who is not certified as a code official in accordance with the VCS shall attend the core module of the Virginia Building Code Academy or an equivalent course in an individual or regional code academy accredited by DHCD within 180 days of appointment. This requirement is in addition to meeting the certification requirement in Section 104.4.2.

J. Section 104.4.4 Requirements for periodic maintenance training and education. Code officials and technical assistants shall attend periodic maintenance training as designated by DHCD. In addition to the periodic maintenance training required above, code officials and technical assistants shall attend 16 hours of continuing education every two years as approved by DHCD. If a code official or technical assistant possesses more than one BHCD certificate, the 16 hours shall satisfy the continuing education requirement for all BHCD certificates.

K. Section 104.4.5 Conflict of interest. The standards of conduct for code officials and technical assistants shall be in accordance with the provisions of the State and Local Government Conflict of Interests Act, Chapter 31 (§ 2.2-3100 et seq.) of Title 2.2 of the Code of Virginia.

L. Section 104.4.6 Records. The local enforcing agency shall retain a record of applications received, permits, certificates, notices and orders issued, fees collected and reports of inspections in accordance with The Library of Virginia's General Schedule Number Six.

M. Section 104.5 Powers and duties, generally. The code official shall enforce this code as set out herein and as interpreted by the State Review Board and shall issue all necessary notices or orders to ensure compliance with the code.

N. Section 104.5.1 Delegation of authority. The code official may delegate powers and duties except where such authority is limited by the local government. When such delegations are made, the code official shall be responsible for assuring that they are carried out in accordance with the provisions of this code.

O. Section 104.5.2 Issuance of modifications. Upon written application by an owner or an owner's agent, the code official may approve a modification of any provision of this code provided the spirit and intent of the code are observed and public health, welfare and safety are assured. The decision of the code official concerning a modification shall be made in writing and the application for a modification and the decision of the code official concerning such modification shall be retained in the permanent records of the local enforcing agency.

P. Section 104.5.2.1 Substantiation of modification. The code official may require or may consider a statement from a professional engineer, architect or other person competent in the subject area of the application as to the equivalency of the proposed modification.

Q. Section 104.5.3 Inspections. The code official may inspect buildings or structures to determine compliance with this code and shall carry proper credentials when performing such inspections. The code official is authorized to engage such expert opinion as deemed necessary to report upon unusual, detailed, or complex technical issues in accordance with local policies.

R. Section 104.5.3.1 Observations. When, during an inspection, the code official or authorized representative observes an apparent or actual violation of another law, ordinance, or code not within the official's authority to enforce, such official shall report the findings to the official having jurisdiction in order that such official may institute the necessary measures.

S. Section 104.5.3.2 Approved inspection agencies and individuals. The code official may accept reports of inspections or tests from individuals or inspection agencies approved in accordance with the code official's written policy required by Section 104.5.3.3. The individual or inspection agency shall meet the qualifications and reliability requirements established by the written policy. Reports of inspections by approved individuals or agencies shall be in writing, shall indicate if compliance with the applicable provisions of this code have been met, and shall be certified by the individual inspector or by the responsible officer when the report is from an agency. The code official shall review and approve the report unless there is cause to reject it. Failure to approve a report shall be in writing within five working days of receiving it, stating the reasons for rejection.

T. Section 104.5.3.3 Third-party inspectors. Each code official charged with the enforcement of this code and that accepts third-party reports shall have a written policy establishing the minimum acceptable qualifications for third-

party inspectors. The policy shall include the format and time frame required for submission of reports, any prequalification or preapproval requirements before conducting a third-party inspection, and any other requirements and procedures established by the code official.

U. Section 104.5.3.4 Qualifications. In determining third-party qualifications, the code official may consider such items as DHCD inspector certification, other state or national certifications, state professional registrations, related experience, education, and any other factors that would demonstrate competency and reliability to conduct inspections.

V. Section 104.5.4 Notices, reports and orders. Upon findings by the code official that violations of this code exist, the code official shall issue a correction notice or notice of violation to the owner or the person responsible for the maintenance of the structure. Work done to correct violations of this code subject to the permit, inspection and approval provisions of the ~~Virginia Construction Code VCC~~ shall not be construed as authorization to extend the time limits established for compliance with this code.

~~S.~~ W. Section 104.5.4.1 Correction notice. The correction notice shall be a written notice of the defective conditions. The correction notice shall require correction of the violation or violations within a reasonable time unless an emergency condition exists as provided under the unsafe building provisions of Section 105. Upon request, the correction notice shall reference the code section that serves as the basis for the defects and shall state that such defects shall be corrected and reinspected in a reasonable time designated by the code official.

~~T.~~ X. Section 104.5.4.2 Notice of violation. If the code official determines there are violations of this code other than those for unsafe structures, unsafe equipment or structures unfit for human occupancy under Section 105, the code official may issue a notice of violation to be communicated promptly in writing to the owner or the person responsible for the maintenance or use of the building or structure in lieu of a correction notice as provided for in Section 104.5.4.1. In addition, the code official shall issue a notice of violation for any uncorrected violation remaining from a correction notice established in Section 104.5.4.1. A notice of violation shall be issued by the code official before initiating legal proceedings unless the conditions violate the unsafe building conditions of Section 105 and the provisions established therein are followed. The code official shall provide the section numbers to the owner for any code provision cited in the notice of violation. The notice shall require correction of the violation or violations within a reasonable time unless an emergency condition exists as provided under the building provisions of Section 105. The owner or person to whom the notice of violation has been issued shall be responsible for contacting the code official within the time frame established for any reinspections to assure the violations have been corrected.

Regulations

The code official will be responsible for making such inspection and verifying the violations have been corrected. In addition, the notice of violation shall indicate the right of appeal by referencing the appeals section of this code.

~~U.~~ Y. Section 104.5.5 Coordination of inspections. The code official shall coordinate inspections and administrative orders with any other state or local agencies having related inspection authority and shall coordinate those inspections required by the Virginia Statewide Fire Prevention Code (13VAC5-51) for maintenance of fire protection devices, equipment and assemblies so that the owners and occupants will not be subjected to numerous inspections or conflicting orders.

Note: The Fire Prevention Code requires the fire official to coordinate such inspections with the code official.

~~V.~~ Z. Section 104.5.6 Further action when violation not corrected. If the responsible party has not complied with the notice of violation, the code official shall submit a written request to the legal counsel of the locality to institute the appropriate legal proceedings to restrain, correct or abate the violation or to require the removal or termination of the use of the building or structure involved. In cases where the locality so authorizes, the code official may issue or obtain a summons or warrant.

~~W.~~ AA. Section 104.5.7 Penalties and abatement. Penalties for violations of this code shall be as set out in § 36-106 of the Code of Virginia. The successful prosecution of a violation of the code shall not preclude the institution of appropriate legal action to require correction or abatement of a violation.

13VAC5-63-490. Section 105 Unsafe structures or structures unfit for human occupancy.

A. Section 105.1 General. This section shall apply to existing structures which are classified as unsafe or unfit for human occupancy. All conditions causing such structures to be classified as unsafe or unfit for human occupancy shall be remedied or as an alternative to correcting such conditions, the structure may be vacated and secured against public entry or razed and removed. Vacant and secured structures shall still be subject to other applicable requirements of this code. Notwithstanding the above, when the code official determines that an unsafe structure or a structure unfit for human occupancy constitutes such a hazard that it should be razed or removed, then the code official shall be permitted to order the demolition of such structures in accordance with applicable requirements of this code.

Note: Structures which become unsafe during construction are regulated under the ~~Virginia Construction Code VCC~~.

B. Section 105.2 Inspection of unsafe or unfit structures. The code official shall inspect any structure reported or discovered as unsafe or unfit for human habitation and shall prepare a report to be filed in the records of the local enforcing agency and a copy issued to the owner. The report

shall include the use of the structure and a description of the nature and extent of any conditions found.

C. Section 105.3 Unsafe conditions not related to maintenance. When the code official finds a condition that constitutes a serious and dangerous hazard to life or health in a structure constructed prior to the initial edition of the USBC and when that condition is of a cause other than improper maintenance or failure to comply with state or local building codes that were in effect when the structure was constructed, then the code official shall be permitted to order those minimum changes to the design or construction of the structure to remedy the condition.

D. Section 105.3.1 Limitation to requirements for retrofitting. In accordance with Section 103.2, this code does not generally provide for requiring the retrofitting of any structure. However, conditions may exist in structures constructed prior to the initial edition of the USBC because of faulty design or equipment that constitute a danger to life or health or a serious hazard. Any changes to the design or construction required by the code official under this section shall be only to remedy the serious hazard or danger to life or health and such changes shall not be required to fully comply with the requirements of the ~~Virginia Construction Code VCC~~ applicable to newly constructed buildings or structures.

E. Section 105.4 Notice of unsafe structure or structure unfit for human occupancy. When a structure is determined to be unsafe or unfit for human occupancy by the code official, a written notice of unsafe structure or structure unfit for human occupancy shall be issued by personal service to the owner, the owner's agent or the person in control of such structure. The notice shall specify the corrections necessary to comply with this code, or if the structure is required to be demolished, the notice shall specify the time period within which the demolition must occur. Requirements in Section 104.5.4 for notices of violation are also applicable to notices issued under this section to the extent that any such requirements are not in conflict with the requirements of this section.

Note: Whenever possible, the notice should also be given to any tenants of the affected structure.

F. Section 105.4.1 Vacating unsafe structure. If the code official determines there is actual and immediate danger to the occupants or public, or when life is endangered by the occupancy of an unsafe structure, the code official shall be authorized to order the occupants to immediately vacate the unsafe structure. When an unsafe structure is ordered to be vacated, the code official shall post a notice with the following wording at each entrance: "THIS STRUCTURE IS UNSAFE AND ITS OCCUPANCY (OR USE) IS PROHIBITED BY THE CODE OFFICIAL." After posting, occupancy of use of the unsafe structure shall be prohibited except when authorized to enter to conduct inspections, make required repairs or as necessary to demolish the structure.

G. Section 105.5 Posting of notice. If the notice is unable to be issued by personal service as required by Section 105.4,

then the notice shall be sent by registered or certified mail to the last known address of the responsible party and a copy of the notice shall be posted in a conspicuous place on the premises.

H. Section 105.6 Posting of placard. In the case of a structure unfit for human habitation, at the time the notice is issued, a placard with the following wording shall be posted at the entrance to the structure: "THIS STRUCTURE IS UNFIT FOR HABITATION AND ITS USE OR OCCUPANCY HAS BEEN PROHIBITED BY THE CODE OFFICIAL." In the case of an unsafe structure, if the notice is not complied with, a placard with the above wording shall be posted at the entrance to the structure. After a structure is placarded, entering the structure shall be prohibited except as authorized by the code official to make inspections, to perform required repairs or to demolish the structure. In addition, the placard shall not be removed until the structure is determined by the code official to be safe to occupy, nor shall the placard be defaced.

I. Section 105.7 Revocation of certificate of occupancy. If a notice of unsafe structure or structure unfit for human habitation is not complied with within the time period stipulated on the notice, the code official shall be permitted to request the local building department to revoke the certificate of occupancy issued under the ~~Virginia Construction Code VCC~~.

J. Section 105.8 Vacant and open structures. When an unsafe structure or a structure unfit for human habitation is open for public entry at the time a placard is issued under Section 105.6, the code official shall be permitted to authorize the necessary work to make such structure secure against public entry whether or not legal action to compel compliance has been instituted.

K. Section 105.9 Emergency repairs and demolition. To the extent permitted by the locality, the code official may authorize emergency repairs to unsafe structures or structures unfit for human habitation when it is determined that there is an immediate danger of any portion of the unsafe structure or structure unfit for human habitation collapsing or falling and when life is endangered. Emergency repairs may also be authorized where there is a code violation resulting in the immediate serious and imminent threat to the life and safety of the occupants. The code official shall be permitted to authorize the necessary work to make the structure temporarily safe whether or not legal action to compel compliance has been instituted. In addition, whenever an owner of an unsafe structure or structure unfit for human habitation fails to comply with a notice to demolish issued under Section 105.4 in the time period stipulated, the code official shall be permitted to cause the structure to be demolished. In accordance with §§ 15.2-906 and 15.2-1115 of the Code of Virginia, the legal counsel of the locality may be requested to institute appropriate action against the property owner to recover the costs associated with any such

emergency repairs or demolition and every such charge that remains unpaid shall constitute a lien against the property on which the emergency repairs or demolition were made and shall be enforceable in the same manner as provided in Articles 3 (§ 58.1-3490 et seq.) and 4 (§ 58.1-3965 et seq.) of Chapter 39 of Title 58.1 of the Code of Virginia.

Note: Code officials and local governing bodies should be aware that other statutes and court decisions may impact on matters relating to demolition, in particular whether newspaper publication is required if the owner cannot be located and whether the demolition order must be delayed until the owner has been given the opportunity for a hearing. In addition, historic building demolition may be prevented by authority granted to local historic review boards in accordance with § 15.2-2306 of the Code of Virginia unless determined necessary by the code official.

L. Section 105.10 Closing of streets. When necessary for public safety, the code official shall be permitted to order the temporary closing of sidewalks, streets, public ways or premises adjacent to unsafe or unfit structures and prohibit the use of such spaces.

13VAC5-63-500. Section 106 Appeals.

A. Section 106.1 Establishment of appeals board. In accordance with § 36-105 of the Code of Virginia, there shall be established within each local enforcing agency a LBBCA. Whenever a county or a municipality does not have such a LBBCA, the local governing body shall enter into an agreement with the local governing body of another county or municipality or with some other agency, or a state agency approved by DHCD for such appeals resulting therefrom. Fees may be levied by the local governing body in order to defray the cost of such appeals. The LBBCA for hearing appeals under the ~~Virginia Construction Code VCC~~ shall be permitted to serve as the appeals board required by this section. The locality is responsible for maintaining a duly constituted LBBCA prepared to hear appeals within the time limits established in this section. The LBBCA shall meet as necessary to assure a duly constituted board, appoint officers as necessary, and receive such training on the code as may be appropriate or necessary from staff of the locality.

B. Section 106.2 Membership of board. The LBBCA shall consist of at least five members appointed by the locality for a specific term of office established by written policy. Alternate members may be appointed to serve in the absence of any regular members and as such, shall have the full power and authority of the regular members. Regular and alternate members may be reappointed. Written records of current membership, including a record of the current chairman and secretary shall be maintained in the office of the locality. In order to provide continuity, the terms of the members may be of different length so that less than half will expire in any one-year period. ~~The LBBCA shall meet at least once annually to assure a duly constituted board, appoint officers~~

Regulations

~~as necessary and receive such training on the code as may be appropriate or necessary from staff of the locality.~~

C. Section 106.3 Officers and qualifications of members. The LBBCA shall annually select one of its regular members to serve as chairman. When the chairman is not present at an appeal hearing, the members present shall select an acting chairman. The locality or the chief executive officer of the locality shall appoint a secretary to the LBBCA to maintain a detailed record of all proceedings. Members of the LBBCA shall be selected by the locality on the basis of their ability to render fair and competent decisions regarding application of the USBC and shall to the extent possible, represent different occupational or professional fields relating to the construction industry. At least one member should be an experienced builder; at least one member should be an RDP, and at least one member should be an experienced property manager. Employees or officials of the locality shall not serve as members of the LBBCA.

D. Section 106.4 Conduct of members. No member shall hear an appeal in which that member has a conflict of interest in accordance with the State and Local Government Conflict of Interests Act (§ 2.2-3100 et seq. of the Code of Virginia). Members shall not discuss the substance of an appeal with any other party or their representatives prior to any hearings.

E. Section 106.5 Right of appeal; filing of appeal application. Any person aggrieved by the local enforcing agency's application of this code or the refusal to grant a modification to the provisions of this code may appeal to the LBBCA. The applicant shall submit a written request for appeal to the LBBCA within 14 calendar days of the receipt of the decision being appealed. The application shall contain the name and address of the owner of the building or structure and, in addition, the name and address of the person appealing, when the applicant is not the owner. A copy of the code official's decision shall be submitted along with the application for appeal and maintained as part of the record. The application shall be marked by the LBBCA to indicate the date received. Failure to submit an application for appeal within the time limit established by this section shall constitute acceptance of a code official's decision.

F. Section 106.6 Meetings and postponements. The LBBCA shall meet within 30 calendar days after the date of receipt of the application for appeal, except that a period of up to 45 calendar days shall be permitted where the LBBCA has regularly scheduled monthly meetings. A longer time period shall be permitted if agreed to by all the parties involved in the appeal. A notice indicating the time and place of the hearing shall be sent to the parties in writing to the addresses listed on the application at least 14 calendar days prior to the date of the hearing, except that a lesser time period shall be permitted if agreed to by all the parties involved in the appeal. When a quorum of the LBBCA is not present at a hearing to hear an appeal, any party involved in the appeal shall have the right to request a postponement of the hearing. The LBBCA

shall reschedule the appeal within 30 calendar days of the postponement, except that a longer time period shall be permitted if agreed to by all the parties involved in the appeal.

G. Section 106.7 Hearings and decision. All hearings before the LBBCA shall be open meetings and the appellant, the appellant's representative, the locality's representative and any person whose interests are affected by the code official's decision in question shall be given an opportunity to be heard. The chairman shall have the power and duty to direct the hearing, rule upon the acceptance of evidence and oversee the record of all proceedings. The LBBCA shall have the power to uphold, reverse or modify the decision of the official by a concurring vote of a majority of those present. Decisions of the LBBCA shall be final if no further appeal is made. The decision of the LBBCA shall be by resolution signed by the chairman and retained as part of the record of the appeal. Copies of the resolution shall be sent to all parties by certified mail. In addition, the resolution shall contain the following wording:

"Any person who was a party to the appeal may appeal to the State Review Board by submitting an application to such Board within 21 calendar days upon receipt by certified mail of this resolution. Application forms are available from the Office of the State Review Board, 600 East Main Street, Richmond, Virginia 23219, (804) 371-7150."

H. Section 106.8 Appeals to the State Review Board. After final determination by the LBBCA in an appeal, any person who was a party to the appeal may further appeal to the State Review Board. In accordance with § 36-98.2 of the Code of Virginia for state-owned buildings and structures, appeals by an involved state agency from the decision of the code official for state-owned buildings or structures shall be made directly to the State Review Board. The application for appeal shall be made to the State Review Board within 21 calendar days of the receipt of the decision to be appealed. Failure to submit an application within that time limit shall constitute an acceptance of the code official's decision. For appeals from a LBBCA, a copy of the code official's decision and the resolution of the LBBCA shall be submitted with the application for appeal to the State Review Board. Upon request by the Office of the State Review Board, the LBBCA shall submit a copy of all pertinent information from the record of the appeal. In the case of appeals involving state-owned buildings or structures, the involved state agency shall submit a copy of the code official's decision and other relevant information with the application for appeal to the State Review Board. Procedures of the State Review Board are in accordance with Article 2 (§ 36-108 et seq.) of Chapter 6 of Title 36 of the Code of Virginia. Decisions of the State Review Board shall be final if no further appeal is made.

13VAC5-63-510. Chapter 2 Definitions.

A. Change Section 201.3 of the IPMC to read:

201.3 Terms defined in other codes. Where terms are not defined in this code and are defined in the ~~International Building Code IBC, International Fire Code IFC, International Plumbing Code IPC, International Mechanical Code IMC, International Existing Building Code, IRC, International Zoning Code or the ICC Electrical Code NFPA 70~~, such terms shall have the meanings ascribed to them in those codes, except that terms defined in the ~~Virginia Construction Code VCC~~ shall be used for this code and shall take precedence over other definitions.

B. Add the following definitions to Section 202 of the IPMC to read:

Structure unfit for human occupancy. An existing structure determined by the code official to be dangerous to the health, safety and welfare of the occupants of the structure or the public because (i) of the degree to which the structure is in disrepair or lacks maintenance, ventilation, illumination, sanitary or heating facilities or other essential equipment, or (ii) the required plumbing and sanitary facilities are inoperable.

Unsafe equipment. Unsafe equipment includes any boiler, heating equipment, elevator, moving stairway, electrical wiring or device, flammable liquid containers or other equipment that is in such disrepair or condition that such equipment is determined by the code official to be dangerous to the health, safety and welfare of the occupants of a structure or the public.

Unsafe structure. An existing structure (i) determined by the code official to be dangerous to the health, safety and welfare of the occupants of the structure or the public, (ii) that contains unsafe equipment, or (iii) that is so damaged, decayed, dilapidated, structurally unsafe or of such faulty construction or unstable foundation that partial or complete collapse is likely. A vacant existing structure unsecured or open shall be deemed to be an unsafe structure.

13VAC5-63-520. Chapter 3 General requirements.

A. Delete Section 302.1 of the IPMC.

B. Change Section 302.2 of the IPMC to read:

302.2 Grading and drainage. All premises shall be graded and maintained to protect the foundation walls or slab of the structure from the accumulation and drainage of surface or stagnant water in accordance with the ~~Virginia Construction Code VCC~~.

C. Change Section 302.3 of the IPMC to read:

302.3 Sidewalks and driveways. All sidewalks, walkways, stairs, driveways, parking spaces and similar spaces regulated under the ~~Virginia Construction Code VCC~~ shall be kept in a proper state of repair, and maintained free from hazardous conditions. Stairs shall comply with the requirements of Sections 305 and 702.

D. Delete Section 302.4 of the IPMC.

E. Change Section 302.5 of the IPMC to read:

302.5 Rodent harborage. All structures and adjacent premises shall be kept free from rodent harborage and infestation where such harborage or infestation adversely affects the structures.

F. Delete Sections 302.8 and 302.9 of the IPMC.

G. Delete Section 304.1.1 of the IPMC.

H. Change Section 304.7 of the IPMC to read:

304.7 Roofs and drainage. The roof and flashing shall be sound, tight and not have defects that admit rain. Roof drainage shall be adequate to prevent dampness or deterioration in the walls or interior portion of the structure. Roof drains, gutters and downspouts shall be maintained in good repair and free from obstructions. Roof water shall be discharged in a manner to protect the foundation or slab of buildings and structures from the accumulation of roof drainage.

I. Change Section 304.14 of the IPMC to read:

304.14 Insect screens. During the period from April 1 to December 1, every door, window and other outside opening required for ventilation of habitable rooms, food preparation areas, food service areas or any areas where products to be included or utilized in food for human consumption are processed, manufactured, packaged or stored, shall be supplied with approved tightly fitting screens of not less than 16 mesh per inch (16 mesh per 25 mm) and every screen door used for insect control shall have a self-closing device in good working condition.

Exception: Screens shall not be required where other approved means, such as mechanical ventilation, air curtains or insect repellent fans, are used.

J. Delete Sections 304.18, 304.18.1, 304.18.2 and 304.18.3 of the IPMC.

K. Delete Section 305.1.1 of the IPMC.

L. Add Section 305.7 to the IPMC to read:

305.7 Carbon monoxide alarms. Carbon monoxide alarms shall be maintained as approved.

M. Delete Section 306 of the IPMC in its entirety.

N. Change Section 308.1 of the IPMC to read as follows and delete the remaining provisions of Section 308:

308.1 Accumulation of rubbish and garbage. The interior of every structure shall be free from excessive accumulation of rubbish or garbage.

O. Change Section 309.1 of the IPMC to read:

309.1 Infestation. This section shall apply to the extent that insect and rodent infestation adversely affects a structure. All structures shall be kept free from insect and rodent infestation. All structures in which insects or rodents are found shall be promptly exterminated by approved processes that will not be injurious to human health. After

Regulations

extermination, proper precautions shall be taken to prevent reinfestation.

P. Add IPMC Section 310 Lead-Based Paint.

Q. Add Section 310.1 to the IPMC to read:

310.1 General. Interior and exterior painted surfaces of dwellings and child care facilities, including fences and outbuildings, that contain lead levels equal to or greater than 1.0 milligram per square centimeter or in excess of 0.50% lead by weight shall be maintained in a condition free from peeling, chipping and flaking paint or removed or covered in an approved manner. Any surface to be covered shall first be identified by approved warning as to the lead content of such surface.

R. Add IPMC Section 311 Aboveground Liquid Fertilizer Storage Tanks (ALFSTs).

S. Add Section 311.1 to the IPMC to read:

311.1 General. ALFSTs shall be maintained in accordance with the requirements of Section ~~3413.16~~ 1701.16 of the ~~Virginia Construction Code VRC~~ and the requirements of the ~~Virginia Construction Code VCC~~ applicable to such ALFSTs when newly constructed; and the requirements of the VRC when undergoing a change of occupancy to an ALFST and when repaired, altered or reconstructed, including the requirements for inspections and for a secondary containment system.

13VAC5-63-525. Chapter 4 Light, ventilation and occupancy limitations. (Repealed.)

A. Change Section 404.4.1 of the IPMC to read:

~~404.4.1 Room area. Every living room shall contain at least 120 square feet (11.2 m²) and every bedroom shall contain at least 70 square feet (6.5 m²) and every bedroom occupied by more than one person shall contain at least 50 square feet (4.6 m²) of floor area for each occupant thereof.~~

B. Change Section 404.5 of the IPMC and add new Table 404.5 to the IPMC to read:

~~404.5 Overcrowding. Dwelling units shall not be occupied by more occupants than permitted by the minimum area requirements of Table 404.5.~~

For SI: 1 square foot = 0.093 m²

^aSee Section 404.5.2 for combined living room/dining room spaces.

^bSee Section 404.5.1 for limitations on determining the minimum occupancy area for sleeping purposes.

C. Add Sections 404.5.1 and 404.5.2 to the IPMC to read:

~~404.5.1 Sleeping area. The minimum occupancy area required by Table 404.5 shall not be included as a sleeping area in determining the minimum occupancy area for sleeping purposes. All sleeping areas shall comply with Section 404.4.~~

~~404.5.2 Combined spaces. Combined living room and dining room spaces shall comply with the requirements of Table 404.5 if the total area is equal to that required for separate rooms and if the space is located so as to function as a combination living room/dining room.~~

13VAC5-63-530. Chapter 5 Plumbing facilities and fixture requirements.

A. Add Section 505.5 to the IPMC to read:

505.5 Inspection and testing of backflow prevention assemblies. Inspection and testing shall comply with Sections 505.5.1 and 505.5.2.

B. Add Section 505.5.1 to the IPMC to read:

505.5.1 Inspections. Inspections shall be made of all backflow prevention assemblies and air gaps to determine whether they are operable.

C. Add Section 505.5.2 to the IPMC to read:

505.5.2 Testing. Reduced pressure principle backflow preventer assemblies, double check-valve assemblies, double-detector check valve assemblies and pressure vacuum breaker assemblies shall be tested at the time of installation, immediately after repairs or relocation and at least annually. The testing procedure shall be performed in accordance with one of the following standards: ASSE 5010-1013-1, Sections 1 and 2; ASSE 5010-1015-1, Sections 1 and 2; ASSE 5010-1015-2; ASSE 5010-1015-3, Sections 1 and 2; ASSE 5010-1015-4, Sections 1 and 2; ASSE 5010-1020-1, Sections 1 and 2; ASSE 5010-1047-1, Sections 1, 2, 3 and 4; ASSE 5010-1048-1, Sections 1, 2, 3 and 4; ASSE 5010-1048-2; ASSE 5010-1048-3, Sections 1, 2, 3 and 4; ASSE 5010-1048-4, Sections 1, 2, 3 and 4; or CAN/CSA B64.10.

D. Change Section 506.3 of the IPMC to read:

~~506.3 Grease interceptors. Grease interceptors, grease traps, and automatic grease removal devices shall be maintained in accordance with this code and the manufacturer's installation instructions. Grease interceptors, grease traps, and automatic grease removal devices shall be regularly serviced and cleaned to prevent the discharge of oil, grease, and other substances harmful or hazardous to the building drainage system, the public~~

Space	Minimum Area in Square Feet		
	1-2 occupants	3-5 occupants	6 or more occupants
Living room ^{a,b}	120	120	150
Dining room ^{a,b}	No requirement	80	100
Bedrooms	Shall comply with Section 404.4.1		

~~sewer, the private sewage disposal system, or the sewage treatment plant or processes. All records of maintenance, cleaning, and repairs shall be available for inspection by the code official.~~

E. D. Change Section 507.1 of the IPMC to read:

507.1 General. Drainage of roofs and paved areas, yards and courts, and other open areas on the premises shall be discharged in a manner to protect the buildings and structures from the accumulation of overland water runoff.

13VAC5-63-540. Chapter 6 Mechanical and electrical requirements.

A. Change Section 602 of the IPMC to read:

Section 602 Heating and Cooling Facilities.

B. Change Section 602.1 of the IPMC to read:

602.1 Facilities required. Heating and cooling facilities shall be maintained and operated in structures as required by this section.

C. Change Section 602.2 of the IPMC to read:

602.2 Heat supply. Every owner and operator of ~~any a~~ Group R-2 apartment building or other residential dwelling who rents, leases or lets one or more dwelling unit, rooming unit, dormitory or guestroom on terms, either expressed or implied, to furnish heat to the occupants thereof shall supply heat during the period from October 15 to May 1 to maintain a temperature of not less than 65°F (18°C) in all habitable rooms, bathrooms, and toilet rooms. The code official may also consider modifications as provided in Section 104.5.2 when requested for unusual circumstances or may issue notice approving building owners to convert shared heating and cooling piping HVAC systems 14 calendar days before or after the established dates when extended periods of unusual temperatures merit modifying these dates.

Exception: When the outdoor temperature is below the winter outdoor design temperature for the locality, maintenance of the minimum room temperature shall not be required provided that the heating system is operating at its full design capacity. The winter outdoor design temperature for the locality shall be as indicated in Appendix D of the ~~International Plumbing Code IPC.~~

D. Add Section 602.2.1 to the IPMC to read:

602.2.1 Prohibited use. In dwelling units subject to Section 602.2, one or more unvented room heaters shall not be used as the sole source of comfort heat in a dwelling unit.

E. Change Section 602.3 of the IPMC to read:

602.3 Occupiable work spaces. Indoor occupiable work spaces shall be supplied with heat during the period from October 1 to May 15 to maintain a temperature of not less than 65°F (18°C) during the period the spaces are occupied.

Exceptions:

1. Processing, storage and operation areas that require cooling or special temperature conditions.
2. Areas in which persons are primarily engaged in vigorous physical activities.

F. Change Section 602.4 of the IPMC to read:

602.4 Cooling supply. Every owner and operator of a Group R-2 apartment building who rents, leases or lets one or more dwelling units, rooming units or guestrooms on terms, either expressed or implied, to furnish cooling to the occupants thereof shall supply cooling during the period from May 15 to October 1 to maintain a temperature of not more than 80°F (27°C) in all habitable rooms. The code official may also consider modifications as provided in Section 104.5.2 when requested for unusual circumstances or may issue notice approving building owners to convert shared heating and cooling piping HVAC systems 14 calendar days before or after the established dates when extended periods of unusual temperatures merit modifying these dates.

Exception: When the outdoor temperature is higher than the summer design temperature for the locality, maintenance of the room temperature shall not be required provided that the cooling system is operating at its full design capacity. The summer outdoor design temperature for the locality shall be as indicated in the ~~International Energy Conservation Code IECC.~~

G. Change the exception to Section 604.3.1.1 of the IPMC to read:

Exception: The following equipment shall be allowed to be repaired or reused where an inspection report from the equipment manufacturer, an approved representative of the equipment manufacturer, a third party licensed or certified electrician, or an electrical engineer indicates that the exposed equipment has not sustained damage that requires replacement:

1. Enclosed switches, rated 600 volts or less;
2. Busway, rated 600 volts or less;
3. Panelboards, rated 600 volts or less;
4. Switchboards, rated 600 volts or less;
5. Fire pump controllers, rated 600 volts or less;
6. Manual and magnetic motor controllers;
7. Motor control centers;
8. Alternating current high-voltage circuit breakers;
9. Low-voltage power circuit breakers;
10. Protective relays, meters and current transformers;
11. Low- and medium-voltage switchgear;
12. Liquid-filled transformers;
13. Cast-resin transformers;
14. Wire or cable that is suitable for wet locations and whose ends have not been exposed to water;

Regulations

15. Wire or cable, not containing fillers, that is suitable for wet locations and whose ends have not been exposed to water;
16. Luminaires that are listed as submersible;
17. Motors;
18. Electronic control, signaling and communication equipment.

H. Change Section 606.1 to the IPCM to read:

606.1 General. Elevators, dumbwaiters and escalators shall be maintained in compliance with ASME A17.1. The most current certificate of inspection shall be on display at all times within the elevator or attached to the escalator or dumbwaiter, be available for public inspection in the office of the building operator or be posted in a publicly conspicuous location approved by the code official. An annual periodic inspection and test is required of elevators and escalators. A locality shall be permitted to require a six-month periodic inspection and test. All periodic inspections shall be performed in accordance with Section 8.11 of ASME A17.1. The code official may also provide for such inspection by an approved agency or through agreement with other local certified elevator inspectors. An approved agency includes any individual, partnership or corporation who has met the certification requirements established by the VCS.

DOCUMENTS INCORPORATED BY REFERENCE
(13VAC5-63)

International Code Council, Inc., 500 New Jersey Avenue, NW, 6th Floor, Washington, DC 20001-2070
(<http://www.iccsafe.org/>):

~~International Building Code - 2009 2012 Edition;~~
~~International Code Council, Inc., 500 New Jersey Avenue, NW, 6th Floor, Washington, DC 20001-2070.~~

~~International Energy Conservation Code - 2009 2012 Edition;~~
~~International Code Council, Inc.~~

~~International Existing Building Code - 2009 2012 Edition;~~
~~International Code Council, Inc.~~

~~International Fire Code - 2009 2012 Edition;~~
~~International Code Council, Inc.~~

~~International Fuel Gas Code - 2009 2012 Edition;~~
~~International Code Council, Inc.~~

~~International Mechanical Code - 2009 2012 Edition;~~
~~International Code Council, Inc.~~

~~International Property Maintenance Code - 2009 2012 Edition;~~
~~International Code Council, Inc.~~

~~International Plumbing Code - 2009 2012 Edition;~~
~~International Code Council, Inc.~~

~~International Residential Code for One- and Two-Family Dwellings - 2009 2012 Edition;~~
~~International Code Council, Inc.~~

International Swimming Pool and Spa Code - 2012 Edition

ICC/ANSI A117.1-09, Accessible and Usable Buildings and Facilities, Approved November 26, 2003

~~AISI S230-07 W/S2-08, Standard for Cold Formed Steel Framing— Prescriptive Method for One and Two Family Dwellings, 2007 Edition with Supplement 2, American Iron and Steel Institute, 1140 Connecticut Avenue NW, Suite 705, Washington, DC 20036.~~

~~ANSI/AF&PA WCFM 2001, Wood Frame Construction Manual for One and Two Family Dwellings, 2001 Edition, Approved October 11, 2001, American Forest and Paper Association, 1111 19th St. NW, Suite 800, Washington, DC 20036.~~

~~ANSI/NSPI 1-2003, American National Standard for Public Swimming Pools, National Spa and Pool Institute, 2111 Eisenhower Avenue, Alexandria, VA 22314.~~

~~ANSI/NSPI 2-1999, American National Standard for Public Spas, National Spa and Pool Institute, 2111 Eisenhower Avenue, Alexandria, VA 22314.~~

ACI 318-11, Building Code Requirements for Structural Concrete, American Concrete Institute, 38800 Country Club Drive, Farmington Hills, MI 48331
(<http://www.concrete.org/>)

American Petroleum Institute, 1220 L Street, NW, Washington, DC 20005-4070 (<http://www.api.org/>):

~~API 650-09, Welded Tanks for Oil Storage, Eleventh Edition, June 2007 (Addendum 1, November 2008, Addendum 2, November 2009, effective May 1, 2010); American Petroleum Institute, 1220 L Street, NW, Washington, DC 20005-4070.~~

~~API 653-09, Tank Inspection, Repair, Alteration, and Reconstruction, American Petroleum Institute.~~

ASHRAE 193-2010, Method of Test for Determining the Airtightness of HVAC Equipment, American Society of Heating, Refrigerating and Air-Conditioning Engineers, Inc., 1791 Tullie Circle, NE, Atlanta, GA 30329-2305
(<https://www.ashrae.org/>)

American Society of Testing Materials International, 100 Barr Harbor Drive, P.O. Box C700, West Conshohocken, PA 19428-2959 (<http://www.astm.org/>):

ASTM C199-84(2005), Standard Test Method for Pier Test for Refractory Mortar

ASTM C315-07, Standard Specification for Clay Flue Liners and Chimney Pots

ASTM C1261-07, Standard Specification for Firebox Brick for Residential Fireplaces

ASTM D1557-07, Standard Test Methods for Laboratory Compaction Characteristics of Soil Using Modified Effort (56,000 ft-lbf/ft³ (2700 kN-m³))

ASTM E90-90, Standard Test Method for Laboratory Measurement of Airborne Sound Transmission Loss of Building Partitions

ASTM E283-04, Standard Test Method for Determining Rate of Air Leakage Through Exterior Windows, Curtain Walls, and Doors Under Specified Pressure Differences Across the Specimen

~~ASTM E329-02, Standard Specification for Agencies Engaged in the Testing and/or Inspection of Materials Used in Construction, American Society of Testing Materials International, 100 Barr Harbor Dr., P.O. Box C700, West Conshohocken, PA 19428-2959.~~

~~ASTM D1557-00, Standard Test Methods for Laboratory Compaction Characteristics of Soil Using Modified Effort (56,000 lbf/ft³ (2,700 kN/m³)), ASTM International.~~

~~ASTM E90-90, Standard Test Method for Laboratory Measurement of Airborne Sound Transmission Loss of Building Partitions, ASTM International.~~

ASTM F2006-10, Standard Safety Specification for Window Fall Prevention Devices for Nonemergency Escape (Egress) and Rescue (Ingress) Windows

ASTM F2090-08, Standard Specification for Window Fall Prevention Devices with Emergency Escape (Egress) Release Mechanisms

CAN/CSA-B64.10-01, Manual for the Selection and Installation of Backflow Prevention Devices/Manual for the Maintenance and Field Testing of Backflow Prevention Devices, June 2003, National Standards of Canada, 5060 Spectrum Way, Suite 100, Mississauga, Ontario, Canada L4W5N6 (<http://www.csa.ca>)

American Society of Mechanical Engineers, Three Park Avenue, New York, NY 10016-5990 (<https://www.asme.org/>):

~~ASME A17.1-2007 / CSA B44-07 ASME A17.1/CSA B44-2007 Safety Code for Elevators and Escalators, American Society of Mechanical Engineers, Three Park Avenue, New York, NY 10016-5990.~~

~~ASME A17.1a-2008 / CSA B44a-08, Addenda to ASME A17.1-2007 / CSA B44-07 ASME A17.1/CSA B44-2010, Safety Code for Elevators and Escalators, American Society of Mechanical Engineers, Three Park Avenue, New York, NY 10016-5990.~~

~~ASME A17.1b-2009 / CSA B44b-09, Addenda to ASME A17.1-2007 / CSA B44-07, Safety Code for Elevators and Escalators, American Society of Mechanical Engineers, Three Park Avenue, New York, NY 10016-5990.~~

ASME A18.1-2011, Safety Standard for Platform Lifts and Stairway Chairlifts

~~ASME A90.1-97, Safety Standard for Belt Manlifts, American Society of Mechanical Engineers, Three Park Avenue, New York, NY 10016-5990.~~

~~ASME B20.1-00, Safety Standard for Conveyors and Related Equipment, American Society of Mechanical Engineers, Three Park Avenue, New York, NY 10016-5990.~~

American Society of Sanitary Engineering, 901 Canterbury Road, Suite A, Westlake, OH 44145 (<http://www.asse-plumbing.org/>):

~~ASSE—1010-98 ASSE 1010-2004, Performance Requirements for Water Hammer Arrestors, American Society of Sanitary Engineering, 901 Canterbury Road, Suite A, Westlake, OH 44145.~~

~~ASSE 5010-1013-1, Field Test Procedure for a Reduced Pressure Principle Assembly Using a Differential Pressure Gauge, 1991, American Society of Sanitary Engineering.~~

~~ASSE 5010-1015-1, Field Test Procedure for a Double Check Valve Assembly Using a Duplex Gauge, 1991, American Society of Sanitary Engineering.~~

~~ASSE 5010-1015-2, Field Test Procedure for a Double Check Valve Assembly Using a Differential Pressure Gauge - High- and Low-Pressure Hose Method, 1991, American Society of Sanitary Engineering.~~

~~ASSE 5010-1015-3, Field Test Procedure for a Double Check Valve Assembly Using a Differential Pressure Gauge - High Pressure Hose Method, 1991, American Society of Sanitary Engineering.~~

~~ASSE 5010-1015-4, Field Test Procedure for a Double Check Valve Assembly Using a Site Tube, 1991, American Society of Sanitary Engineering.~~

~~ASSE 5010-1020-1, Field Test Procedures for a Pressure Vacuum Breaker Assembly, 1991, American Society of Sanitary Engineering.~~

~~ASSE 5010-1047-1, Field Test Procedure for a Reduced Pressure Detector Assembly Using a Differential Pressure Gauge, 1991, American Society of Sanitary Engineering.~~

~~ASSE 5010-1048-1, Field Test Procedure for a Double Check Detector Assembly Using a Duplex Gauge, 1991, American Society of Sanitary Engineering.~~

~~ASSE 5010-1048-2, Field Test Procedure for a Double Check Detector Assembly Using a Differential Pressure Gauge - High- and Low-Pressure Hose Method, 1991, American Society of Sanitary Engineering.~~

~~ASSE 5010-1048-3, Field Test Procedure for a Double Check Detector Assembly Using a Differential Pressure Gauge - High-Pressure Hose Method, 1991, American Society of Sanitary Engineering.~~

~~ASSE 5010-1048-4, Field Test Procedure for a Double Check Detector Assembly Using a Site Tube, 1991, American Society of Sanitary Engineering.~~

ICC/ANSI A117.1-2003, Accessible and Usable Buildings and Facilities, Approved November 26, 2003, International Code Council, 500 New Jersey Avenue, NW, 6th Floor, Washington, DC 20001-2070.

ICC 600-2008, Standard for Residential Construction in High Wind Regions, Approved August 6, 2008, International Code Council, Inc.

Regulations

~~SEI/ASCE 7-05~~ ASCE/SEI 7-10, Minimum Design Loads for Buildings and Other Structures, American Society of Civil Engineers/Structural Engineering Institute, 1801 Alexander Bell Drive, Reston, VA 20191-4400. (<http://www.asce.org/sei/>)

National Fire Protection Association, 1 Batterymarch Park, Quincy, MA 02169-7471 (<http://www.nfpa.org/>):

NFPA 13-10, Installation of Sprinkler Systems

NFPA 13R-10, Installation of Sprinkler Systems in Residential Occupancies Up to and Including Four Stories in Height

~~NFPA 13D-07~~ NFPA 13D-10, Standard for the Installation of Sprinkler Systems in One- and Two-Family Dwellings and Manufactured Homes, National Fire Protection Association, Batterymarch Park, Quincy, MA 02269

~~NFPA 70-08~~ NFPA 70-11, National Electrical Code, 2008 Edition, National Fire Protection Association, Batterymarch Park, Quincy, MA 02269

NFPA 72-10, National Fire Alarm Code

NFPA 105-10, Standard for the Installation of Smoke Door Assemblies

~~NFPA 495-01~~, Explosive Materials Code, National Fire Protection Association, Batterymarch Park, Quincy, MA 02269

NFPA 701-10, Standard Methods of Fire Tests for Flame-propagation of Textiles and Films

~~NFPA 704-07~~ NFPA 704-12, Standard System for the Identification of the Hazards of Materials for Emergency Response, National Fire Protection Association, Batterymarch Park, Quincy, MA 02269

TFI RMIP-09, Aboveground Storage Tanks Containing Liquid Fertilizer, Recommended Mechanical Integrity Practices, December 2009, The Fertilizer Institute, 820 First Street, NE, Suite 430, Washington, DC 20002

Underwriters Laboratories, Inc., 333 Pfingsten Road, Northbrook, IL 60062 (<http://www.ul.com/>):

UL 1784-01, Air Leakage Tests of Door Assemblies, revised July 2009

~~UL 2034~~ UL 2034-2008, Standard for Single and Multiple Station Carbon Monoxide Alarms, ~~Third Edition, February 28, 2008, including revisions through, revised February 20, 2009, Underwriters Laboratories, Inc. 333 Pfingsten Road, Northbrook, IL 60062.~~

[Interim Remediation Guidance for Homes with Corrosion from Problem Drywall, April 2, 2010, Joint Report, Consumer Products Safety Commission and Department of Housing and Urban Development](#)

VA.R. Doc. No. R12-3159; Filed June 27, 2013; 9:56 a.m.

Proposed Regulation

REGISTRAR'S NOTICE: The Board of Housing and Community Development is claiming an exemption from the

Administrative Process Act pursuant to § 2.2-4006 A 12 of the Code of Virginia, which excludes regulations adopted pursuant to the Industrialized Building Safety Law (§ 36-70 et seq. of the Code of Virginia).

Title of Regulation: **13VAC5-91. Virginia Industrialized Building Safety Regulations (amending 13VAC5-91-10, 13VAC5-91-20, 13VAC5-91-40, 13VAC5-91-60, 13VAC5-91-100, 13VAC5-91-115, 13VAC5-91-120, 13VAC5-91-140, 13VAC5-91-150, 13VAC5-91-160, 13VAC5-91-170, 13VAC5-91-180, 13VAC5-91-210, 13VAC5-91-220, 13VAC5-91-240, 13VAC5-91-260, 13VAC5-91-270; repealing 13VAC5-91-130).**

Statutory Authority: § 36-73 of the Code of Virginia.

Public Hearing Information:

September 23, 2013 - 10 a.m. - Virginia Housing Center, 4224 Cox Road, Glen Allen, VA

Public Comment Deadline: September 29, 2013.

Agency Contact: Stephen W. Calhoun, Regulatory Coordinator, Department of Housing and Community Development, Main Street Centre, 600 East Main Street, Suite 300, Richmond, VA 23219, telephone (804) 371-7000, FAX (804) 371-7090, TTY (804) 371-7089, or email steve.calhoun@dhcd.virginia.gov.

Background: The Virginia Industrialized Building Safety Regulations (IBSR) govern the in-factory construction of industrialized buildings, also known as modular buildings. The regulations provide the same standards for construction as those buildings constructed on-site and regulated by the Virginia Uniform Statewide Building Code (13VAC5-63). Both regulations utilize nationally recognized model building codes and standards to provide the technical requirements for the actual construction of the regulated buildings. The model codes are produced by the International Code Council and, every three years, new editions of the model codes become available. At that time, the Board of Housing and Community Development initiates a regulatory action to incorporate the newer editions of the model codes into the regulations through the publishing of a proposed regulation.

Summary:

The proposed amendments (i) conform the regulations to statutory provisions and updated industry standards; (ii) coordinate the application of the regulation with the other building code and fire code regulations of the board; (iii) revise the definition of compliance assurance agency (CAA) to allow the placement of CAAs labels on industrialized buildings in one location; (iv) add definitions for label, certification label, compliance assurance agency certification label, seal, registration seal, and Virginia registration seal to clarify the meaning of each label or seal; (v) change the name of the State Building Code Administrative Office to the State Building Codes Office (SBCO); (vi) revise the exemption for storage containers; (vii) clarify the right to appeal any

administrator order; (viii) clarify that the building official can require the correction of any regulatory violation before the registered industrialized building may be occupied; (ix) delete the terms "defects" and "noncompliance," which are not defined by the adopted building codes; (x) clarify that a change in use of an industrialized building is subject to 13VAC-5-91; (xi) delete redundant provisions or provisions not required by law and revise or move provisions for consistency; (xii) require a compliance assurance agency to make application for acceptance by the SBCO; (xiii) clearly delineate the terms of approval of CAAs by the SBCO and define when approval of a CAA may be suspended or revoked; (xiv) clarify that CAA certification labels must be applied to a registered industrialized building prior to shipment of the building from the place of manufacture; (xv) clarify that CAA certification labels and SBCO certification seals may be applied either by the CAA or the manufacturer when authorized by the CAA; (xvi) require that registration seals must be purchased from the SBCO and decrease the cost of registration seals for building constructed as R-5 (residential) from \$75 to \$50 per module; and (xvii) allow a partial refund of a certification seal and a deduction from the refund of a processing fee of 25% of the refund due, not to exceed \$250.

13VAC5-91-10. Definitions.

The following words and terms when used in this chapter shall have the following meanings unless the context clearly indicates otherwise.

"Administrator" means the Director of DHCD or his designee.

"Approved" as applied to a material, device, method of construction, registered building, or as otherwise used in this chapter means approved by the administrator.

"Building official" means the officer or other designated authority charged with the administration and enforcement of the USBC, or duly authorized representative.

"Compliance assurance agency" means an architect or professional engineer registered in Virginia, or an organization, determined by DHCD to be specially qualified by reason of facilities, personnel, experience, and demonstrated reliability, to investigate, test and evaluate industrialized buildings; to list such buildings complying with standards at least equal to this chapter; to provide adequate follow-up services at the point of manufacture to ensure that production units are in full compliance; and to provide a label as evidence of compliance on each manufactured section or module.

"DHCD" means the Virginia Department of Housing and Community Development.

"ICC" means the International Code Council, Inc.

"Industrialized building" means a combination of one or more sections or modules, subject to state regulations and

including the necessary electrical, plumbing, heating, ventilating, and other service systems, manufactured off-site and transported to the point of use for installation or erection, with or without other specified components, to comprise a finished building. Manufactured homes defined in § 36-85.3 of the Code of Virginia and certified under the provisions of the National Manufactured Housing Construction and Safety Standards Act (42 USC § 5401 et seq.) shall not be considered industrialized buildings for the purpose of this law.

"Label," "certification label," or "compliance assurance agency certification label" means the label required by 13VAC5-91-210.

"Model" means a specific design of an industrialized building designated by the producer of the building including production buildings with variations and options that do not affect compliance with the standards governing structural, plumbing, mechanical, or electrical systems or any other items governed by this chapter.

"Registered" means an industrialized building which displays a registration seal issued by DHCD in accordance with this chapter.

"Seal," "registration seal," or "Virginia registration seal" means the seal required by 13VAC5-91-260.

"SBCAO" "SBCO" means the State Building Code Administrative Codes Office within DHCD.

"State Review Board" means the Virginia State Building Code Technical Review Board as established by § 36-108 of the Code of Virginia.

"This law" means the Virginia Industrialized Building Safety Law as embraced in Chapter 4 (§ 36-70 et seq.) of Title 36 of the Code of Virginia.

"USBC" means the Virginia Uniform Statewide Building Code (13VAC5-63).

13VAC5-91-20. Application and compliance.

A. In accordance with § 36-81 of the Code of Virginia, registered industrialized buildings shall be acceptable in all localities as meeting the requirements of the Industrialized Building Safety Law (Chapter 4 (§ 36-70 et seq.) of Title 36 of the Code of Virginia), which shall supersede the building codes and regulations of the counties, municipalities and state agencies. Local requirements affecting industrialized buildings, including zoning, utility connections, preparation of the site and maintenance of the unit shall remain in full force and effect. All building officials are authorized to and shall enforce the provisions of the Industrialized Building Safety Law (Chapter 4 (§ 36-70 et seq.) of Title 36 of the Code of Virginia) and this chapter.

B. In accordance with § 36-78 of the Code of Virginia, no person, firm or corporation shall offer for sale or rental, or sell or rent, any industrialized building subject to any provisions of this chapter unless it conforms with the applicable provisions of this chapter.

Regulations

Further, any industrialized building constructed before January 1, 1972, shall remain subject to the ordinances, laws or regulations in effect at the time such industrialized building was constructed. Additionally, as a requirement of this chapter, any industrialized building bearing the label of a compliance assurance agency shall remain subject to the provisions of this chapter that were effective when such building was constructed, regardless of whether the building has been relocated.

C. In accordance with § 36-99 of the Code of Virginia and in accordance with the USBC, the installation or erection of industrialized buildings and alterations, additions, or repairs to industrialized buildings are regulated by the USBC and not this chapter. The USBC provides for administrative requirements for permits, inspections, and certificates of occupancy for such work.

D. ~~Shipping Off-site manufactured intermodal freight containers and portable on-demand storage (PODS), moving containers, and storage containers placed on site temporarily or permanently for use as a storage container~~ are not subject to this chapter.

13VAC5-91-40. Inspection and enforcement by administrator.

A. The ~~SBCAO~~ SBCO is designated as the administrator's representative for the enforcement of this chapter and shall act as the building official for registered industrialized buildings. It shall have authority to make inspections during reasonable hours at the manufacturing facilities and at building sites where industrialized buildings are being installed. The ~~SBCAO~~ SBCO shall have authority to issue inspection reports for correction of violations caused by the manufacturer and to take such other actions as are required to enforce this chapter.

B. The ~~SBCAO~~ SBCO will maintain a list of approved compliance assurance agencies. Each manufacturer producing registered industrialized buildings will contract with one or more compliance assurance agencies for required evaluation, monitoring and inspection services. The contract will delineate the services to be provided by the compliance assurance agency. The compliance assurance agency will notify the ~~SBCAO~~ SBCO within 30 days of signing a new contract or terminating an existing contract with any manufacturer.

13VAC5-91-60. Notice of violation from administrator.

In accordance with § 36-82 of the Code of Virginia, whenever the administrator shall find any violation of this chapter, he shall order the person responsible therefor to bring the building into compliance within a reasonable time, to be fixed in the order. In addition, as a requirement of this chapter, the administrator may request assistance from the building official for enforcement of this section. Any order issued by the administrator pursuant to this section shall contain a statement explaining the right of appeal of the order.

13VAC5-91-100. Duties and responsibilities of building officials in the installation or erection of a registered industrialized building.

A. All building officials are authorized by § 36-81 of the Code of Virginia to enforce the provisions of this chapter and shall be responsible for and authorized to do the following:

1. Verify through inspection that the registered industrialized building displays the required state registration seal and the proper label of the compliance assurance agency.

2. Verify through inspection that the registered industrialized building has not been damaged in transit to a degree that would render it unsafe. If the building has been damaged, then the building official is authorized to require tests for tightness of plumbing systems and gas piping and an operational test to ensure that all luminaries and receptacles are operable.

3. ~~Prevent the use or occupancy of a registered industrialized building that in the opinion of the building official contains a serious defect or imminent safety hazard and notify the SBCAO immediately. If warranted due to the nature of any violations discovered, the building official shall be permitted to require the correction of any violations of this chapter before occupancy of the registered industrialized building is permitted.~~

4. Notify the ~~SBCAO~~ SBCO of any apparent violations of this chapter ~~to include defects and noncompliance.~~

B. In accordance with § 36-99 of the Code of Virginia and the USBC, all site work associated with the installation or erection of an industrialized building is subject to the USBC. In addition, under the USBC, all administrative requirements for permits, inspections, and certificates of occupancy are also applicable.

13VAC5-91-115. Change of occupancy classification.

When the occupancy classification of a registered industrialized building is proposed to be changed, a compliance assurance agency shall inspect the building, including any disassembly necessary, to determine whether compliance may be achieved for a change of occupancy classification in accordance with ~~the USBC this chapter.~~ If factory plans are available, then disassembly is not required to the extent that the factory plans can be reasonably verified to reflect the actual construction. Once any necessary work is completed, the compliance assurance agency shall prepare a report documenting the method utilized for the change of occupancy and any alterations to the building to achieve compliance. When the report is complete, the compliance assurance agency shall (i) mark the building with a new compliance assurance agency label in accordance with 13VAC5-91-210, which replaces the existing label; (ii) place a new manufacturer's data plate on the building in accordance with 13VAC5-91-245, which replaces the existing manufacturer's data plate and reflects the new occupancy

classification; and (iii) forward a copy of the report and new data plate to the ~~SBCAO~~ SBCO.

13VAC5-91-120. Unregistered industrialized buildings.

A. The building official shall determine whether any unregistered industrialized building complies with this chapter and shall require any noncomplying unregistered building to be brought into compliance with this chapter. The building official shall enforce all applicable requirements of this chapter including those relating to the sale, rental and disposition of noncomplying buildings. The building official may require submission of full plans and specifications for each building. Concealed parts of the building may be exposed to the extent necessary to permit inspection to determine compliance with the applicable requirements. The building official may also accept reports of inspections and tests from individuals or agencies deemed acceptable to the building official.

~~B. Unregistered industrialized buildings offered for sale in this Commonwealth shall be marked by a warning sign to prospective purchasers that the building is not registered in accordance with this chapter and must be inspected and approved by the building official. The sign shall be of a size and form approved by the administrator and shall be conspicuously posted on the exterior of the unit near the main entrance door. This requirement shall not apply to residential accessory buildings.~~

~~C. B.~~ An existing unregistered industrialized building may be registered in accordance with one of the following:

1. Where an unregistered building was constructed under an industrialized building program of another state and approved under such program, a compliance assurance agency shall prepare a report based on review of the plans and specifications and inspection of the building to determine whether there is compliance with the construction requirements of this chapter that were in effect on the date of manufacture of the building. If compliance is determined, the compliance assurance agency shall (i) mark the building with a compliance assurance agency label in accordance with 13VAC5-91-210, (ii) place a new manufacturer's data plate on the building in accordance with 13VAC5-91-245, (iii) mark the building with a registration seal in accordance with 13VAC5-91-260, and (iv) forward a copy of the report and new data plate to the ~~SBCAO~~ SBCO.

2. Where an unregistered building was not approved under an industrialized building program of another state and the date of manufacture can be verified, the compliance assurance agency shall inspect the building, including any disassembly necessary, to determine whether there is compliance with the construction requirements of this chapter that were in effect on the date of manufacture of the building. When factory plans are available, then disassembly is not required to the extent that the factory plans can be verified to reflect the actual construction of

the building. When compliance with the construction requirements of this chapter that were in effect on the date of manufacture of the building is achieved, the compliance assurance agency shall prepare a report documenting compliance, outlining any changes made to the building, and certifying the building in accordance with clauses (i) through (iv) of subdivision 1 of this subsection.

3. When the date of manufacture of the existing unregistered building cannot be verified, the building shall be evaluated for compliance with the codes and standards specified in 13VAC5-91-160. The compliance assurance agency shall inspect the building, including any disassembly necessary, to determine whether there is compliance with these construction requirements. If compliance is achieved, the compliance assurance agency shall prepare a report documenting compliance, outlining any changes made to the building, and certifying the building in accordance with clauses (i) through (iv) of subdivision 1 of this subsection.

~~**13VAC5-91-130. Disposition of noncomplying building. (Repealed.)**~~

~~When a building is found to be in violation of this chapter, the building official may require the violations to be corrected before occupancy of the building is permitted.~~

13VAC5-91-140. Report to the ~~SBCAO~~ SBCO.

If the building is moved from the jurisdiction before the violations have been corrected, the building official shall make a prompt report of the circumstances to the ~~SBCAO~~ SBCO. The report shall include all of the following:

1. A list of the uncorrected violations.
2. All information contained on the label pertinent to the identification of the building, the manufacturer and the compliance assurance agency.
3. The number of the Virginia registration seal.
4. The new destination of the building, if known.
5. The party responsible for moving the building.

13VAC5-91-150. When modification may be granted.

~~A.~~ The administrator shall have the power upon request in specific cases to authorize modification of this chapter so as to permit certain specified alternatives where the objectives of this law can still be fulfilled. Such request shall be in writing and shall be accompanied by the plans, specifications and other information necessary for an adequate evaluation of the modification requested.

~~B. Before a modification is authorized, the building official may be afforded an opportunity to present his views and recommendations.~~

13VAC5-91-160. Use of model codes and standards.

A. Industrialized buildings produced after the effective date of the ~~2009~~ 2012 edition of this chapter shall comply with all applicable requirements of the codes and standards listed in subsection B of this section except that the following codes

Regulations

and standards may be used for ~~90 days~~ one year after the effective date of the ~~2009~~ 2012 edition of this chapter:

1. ICC International Building Code - ~~2006~~ 2009 Edition
2. ICC International Plumbing Code - ~~2006~~ 2009 Edition
3. ICC International Mechanical Code - ~~2006~~ 2009 Edition
4. National Fire Protection Association Standard Number 70 (National Electrical Code) - ~~2005~~ 2008 Edition
5. ICC International Fuel Gas Code - 2009 Edition
6. ICC International Energy Conservation Code - 2009 Edition
- ~~5.~~ 7. ICC International Residential Code - ~~2006~~ 2009 Edition

B. The following documents are adopted and incorporated by reference to be an enforceable part of this chapter:

1. ICC International Building Code - ~~2009~~ 2012 Edition
2. ICC International Plumbing Code - ~~2009~~ 2012 Edition
3. ICC International Mechanical Code - ~~2009~~ 2012 Edition
4. National Electrical Code - ~~2008~~ 2011 Edition
5. ICC International Fuel Gas Code - 2012 Edition
6. ICC International Energy Conservation Code - 2012 Edition
- ~~5.~~ 7. ICC International Residential Code - ~~2009~~ 2012 Edition

Note: As the ~~2009~~ 2012 editions of the International Codes are incorporated by reference as the construction standards for use with these regulations, this chapter is also referred to as the ~~2009~~ 2012 edition of the Virginia Industrialized Building Safety Regulations or the ~~2009~~ 2012 edition of this chapter.

The codes and standards referenced above may be procured from:

International Code Council, Inc.
500 New Jersey Avenue, NW, 6th Floor
Washington, DC 20001-2070

13VAC5-91-170. Amendments to codes and standards.

A. All requirements of the referenced model codes and standards that relate to fees, permits, certificates of use and occupancy, approval of plans and specifications, and other procedural, administrative and enforcement matters are deleted and replaced by the procedural, administrative and enforcement provisions of this chapter ~~and the applicable provisions of Chapter 1 of the USBC.~~

B. The referenced codes and standards are amended as set forth in the USBC.

13VAC5-91-180. Compliance assurance agencies.

A. Application ~~may~~ shall be made to the ~~SBCAO~~ SBCO for acceptance as a compliance assurance agency. Application shall be made under oath and shall be accompanied by information and evidence that is adequate for the ~~SBCAO~~

SBCO to determine whether the applicant is specially qualified by reason of facilities, personnel, experience and demonstrated reliability to investigate, test and evaluate industrialized buildings for compliance with this chapter, and to provide adequate follow-up and compliance assurance services at the point of manufacture.

B. Following a determination by the SBCO that an application is complete, the information contained in the application and any other information deemed necessary by the SBCO will be reviewed for approval or disapproval. If the application is approved, the applicant will be notified with an approval letter for a two-year period from the date of the approval letter. If the application is disapproved, the applicant will be notified in writing of the reasons for the disapproval. The applicant may then resubmit the application within 30 days of the receipt of the notification of disapproval for reconsideration of approval.

C. Compliance assurance agencies that are already approved by the SBCO at the time of the effective date of this provision shall have 90 days from the effective date of this provision to apply for reapproval in accordance with subsections A and B of this section. Such agencies shall continue to be approved while the SBCO evaluates the reapplication. Compliance assurance agencies receiving an approval letter from the SBCO after the effective date of this provision shall apply for reapproval within 90 days prior to the expiration of the two-year approval period if continued approval as a compliance assurance agency is desired.

D. The SBCO may suspend or revoke the approval of a compliance assurance agency upon a determination that (i) approval or reapproval was based upon fraudulent or inaccurate information, (ii) a change in facts or circumstances renders the agency incapable of meeting its duties and responsibilities as a compliance assurance agency in a satisfactory manner, or (iii) the agency failed to discharge its duties and responsibilities as a compliance assurance agency in a satisfactory manner. In such cases, the SBCO will issue a suspension or revocation notice to the agency outlining the reasons for the actions and the terms, if any, for reinstatement.

13VAC5-91-210. Compliance assurance agency certification label.

Every manufactured section or module of a registered A. Registered industrialized building buildings shall be marked with a label certification labels supplied by the compliance assurance agency that includes the name and address of the compliance assurance agency and the numbers of the certification label number labels. The labels shall be applied to registered industrialized buildings intended for sale or use in Virginia and shall be applied prior to the shipment of the building from the place of manufacture. The labels shall be applied by the compliance assurance agency or by the manufacturer when so authorized by the compliance assurance agency.

B. Registered industrialized buildings shall bear one certification label on each manufactured section or module, or as an alternative, the certification label for each manufactured section or module may be placed in one location in the completed building.

13VAC5-91-220. Mounting of compliance assurance agency certification label.

To the extent practicable, the certification label shall be installed so that it cannot be removed without destroying it. The label shall be applied in the vicinity of the electrical distribution panel or in another location that is readily accessible for inspection and shall be installed near the registration seal. ~~When a building is comprised of more than one section or module, the required label may be furnished as a single label for the entire building provided each section or module is marked by the compliance assurance agency in a clearly identifiable manner provided with or on the label.~~

13VAC5-91-240. ~~Label control~~ Control of compliance assurance agency certification label.

The labels shall be under direct control of the compliance assurance agency until applied by the manufacturer to buildings that comply fully with this chapter. The manufacturer shall place its order for labels with the compliance assurance agency. The manufacturer is not permitted to acquire labels from any other source. Each compliance assurance agency shall keep a list of the serial numbers of labels issued to each manufacturer's plant in such manner that a copy of the record can be submitted to the administrator upon request.

13VAC5-91-260. Registration seal for industrialized buildings.

A. Registered industrialized buildings shall be marked with approved registration seals issued by the ~~SBCAO~~ SBCO. The seals shall be applied ~~by the manufacturer~~ to a registered industrialized building intended for sale or use in Virginia prior to the shipment of the building from the place of manufacture. The seals shall be applied by the compliance assurance agency or by the manufacturer when authorized to do so by the compliance assurance agency.

B. Registered industrialized buildings shall bear one registration seal on each manufactured section or module, or, as an alternative, the registration seal for each manufactured section or module may be placed in one location in the completed building.

C. Approved registration seals ~~may~~ shall be purchased from the ~~SBCAO~~ SBCO in advance of use. The fee for each registration seal shall be \$75, except that the fee for each registration seal for buildings constructed as Group R-5 under Part I of the USBC shall be \$50. Fees shall be submitted by checks made payable to "Treasurer of Virginia" or shall be submitted by electronic means. Payment for the seals must be received by the ~~SBCAO~~ SBCO before the seals can be sent to the user.

D. To the extent practicable, the registration seal shall be installed so that it cannot be removed without destroying it. ~~The seal shall be applied in the vicinity of the electrical distribution panel or in another location that is readily accessible for inspection and shall be installed near the certification label applied by the compliance assurance agency.~~

E. The compliance assurance agency or the manufacturer under the supervision of the compliance assurance agency shall maintain permanent records of the disposition of all Virginia registration seals obtained by the compliance assurance agency or manufacturer.

F. Refunds of seals shall be in accordance with § 36-85.1 of the Code of Virginia. An administrative and processing fee of 25% of the amount of the refund due shall be deducted from the refund; however, such deduction shall not exceed \$250.

13VAC5-91-270. Manufacturer's installation instructions and responsibilities of installers.

A. The manufacturer of each industrialized building shall provide specifications or instructions, or both, with each building for handling, installing or erecting the building. Such instructions may be included as part of the label from the compliance assurance agency or may be furnished separately by the manufacturer of the building. The manufacturer shall not be required to provide the foundation and anchoring equipment for the industrialized building.

B. Persons or firms installing or erecting registered industrialized buildings shall install or erect the building in accordance with the manufacturer's instructions.

C. Where the installation or erection of an industrialized building utilizes components that are to be concealed, the installer shall notify and obtain approval from the building official prior to concealment of such components unless the building official has agreed to an alternative method of verification.

Note: The Virginia Department of Professional and Occupational Regulation's Board for Contractors requires licenses for certain activities related to the industrialized building industry. For more information, contact the Board for Contractors.

DOCUMENTS INCORPORATED BY REFERENCE (13VAC5-91)

International Code Council, 500 New Jersey Avenue, NW, 6th Floor, Washington, DC 20001-2070 (<http://shop.iccsafe.org/codes.html>):

ICC International Plumbing Code -- 2006 and 2009 and 2012 Editions, International Code Council

ICC International Mechanical Code -- 2006 and 2009 and 2012 Editions, International Code Council

National Fire Protection Association Standard Number 70 (National Electrical Code) -- 2005 and 2008 Editions

Regulations

ICC International Building Code -- 2006 and 2009 and 2012 Editions, International Code Council

ICC International Residential Code -- 2006 and 2009 and 2012 Editions, International Code Council

ICC International Fuel Gas Code -- 2009 and 2012 Editions

ICC International Energy Conservation Code -- 2009 and 2012 Editions

NFPA 70, National Electrical Code -- 2008 and 2011 Editions, National Fire Protection Association, 1 Batterymarch Park, Quincy, MA 02169-7471 (<http://www.nfpa.org/>)

ASTM Standard Number E541-08 -- Standard Specification for Agencies Engaged in System Analysis and Compliance Assurance for Manufactured Building, American Society for Testing and Materials, 100 Barr Harbor Drive, West Conshohocken, PA 19428-2959 (<http://www.astm.org/>)

VA.R. Doc. No. R12-3162; Filed June 27, 2013, 9:55 a.m.

TITLE 18. PROFESSIONAL AND OCCUPATIONAL LICENSING

VIRGINIA BOARD FOR ASBESTOS, LEAD, AND HOME INSPECTORS

Notice of Objection to Fast-Track Rulemaking

REGISTRAR'S NOTICE: Pursuant to § 2.2-4012.1 of the Code of Virginia, the Virginia Board for Asbestos, Lead, and Home Inspectors has filed a notice of objection to the fast-track rulemaking action published in [29:20 VA.R. 2439-2441 June 3, 2013](#). The board intends to proceed with the normal promulgation process set out in Article 2 (§ 2.2-4006 et seq.) of Chapter 40 of the Administrative Process Act with the initial publication of the fast-track regulation serving as the Notice of Intended Regulatory Action.

Title of Regulation: **18VAC15-40. Virginia Certified Home Inspectors Regulations (amending 18VAC15-40-30).**

Statutory Authority: §§ 54.1-201 and 54.1-501 of the Code of Virginia.

Fast-Track Publication Date: [29:20 VA.R. 2439-2441 June 3, 2013](#).

The fast-track action was intended to remove the restriction that training courses to meet the certified home inspector entry requirements be conducted in a classroom setting. More than 10 persons objected to the fast-track process during the public comment period, which ended July 3, 2013. Consequently, in accordance with § 2.2-4012.1 of the Code of Virginia, the agency has terminated the fast-track process and is proceeding with the normal promulgation process.

Agency Contact: Trisha L. Henshaw, Executive Director, Virginia Board for Asbestos, Lead, and Home Inspectors, 9960 Mayland Drive, Suite 400, Richmond, VA 23233, telephone (804) 367-8595, FAX (804) 350-5354, or email alhi@dpor.virginia.gov.

VA.R. Doc. No. R13-2848; Filed July 8, 2013, 9:41 a.m.

BOARD OF NURSING

Emergency Regulation

Title of Regulation: **18VAC90-20. Regulations Governing the Practice of Nursing (adding 18VAC90-20-215).**

Statutory Authority: § 54.1-2400 of the Code of Virginia.

Effective Dates: August 1, 2013, through July 31, 2014.

Agency Contact: Jay P. Douglas, R.N., Executive Director, Board of Nursing, 9960 Mayland Drive, Suite 300, Richmond, VA 23233-1463, telephone (804) 367-4515, FAX (804) 527-4455, or email jay.douglas@dhp.virginia.gov.

Preamble:

Legislation for provisional licensure was introduced at the request of Excelsior College, a nontraditional nursing education program that is competency-based and does not provide didactic coursework or any hours of precepted clinical experience. Therefore, its graduates do not meet the Board of Nursing requirement for licensure of 500 hours of supervised clinical experience (effective in 2008). While most other out-of-state, nontraditional nursing education programs do meet board requirements for hours of clinical experience, there are a few whose applicants have less than the requisite number of hours. In 2009, the board adopted regulations for endorsement of applicants from other states with a requisite number of clinical experience hours, but there has been no resolution for new graduates of programs such as Excelsior that do not meet Virginia's regulation for the number of clinical hours required for licensure by examination.

Chapter 712 of the 2011 Acts of Assembly authorizes the board to adopt regulations to provide a pathway to licensure by the issuance of a provisional license to allow a graduate who has met the educational and examination requirements but is lacking clinical experience to obtain such experience by practicing under the supervision of a registered nurse for a period of time. The regulations for provisional licensure will assure that the RN applicant gains experience across the life span in all areas of nursing practice and that his practice will be overseen by an RN with at least two years of clinical practice experience. The supervisor is responsible for the assignment of duties consistent with the knowledge and skills of the provisional licensee and must be prepared to intervene if necessary for the health and safety of clients receiving care from a provisional licensee.

Chapter 712 further required that the board promulgate regulations to implement the provisions of the act to be

effective within 280 days of its enactment. The board submitted the emergency regulation for executive branch review on September 29, 2011. The statutory deadline for regulations to be in effect was December 31, 2011, but the Secretary of Health and Human Resources requested that the board reexamine the proposed emergency regulations to address concerns expressed by Excelsior College.

The key provisions of the regulations are (i) requirements for qualification and submission of documents for approval as a provisional licensee; (ii) requirements for 500 hours of direct client care in the role of a registered nurse including various areas of nursing; (iii) provisions for acceptance of previous clinical experience towards meeting the 500-hour requirement; (iv) requirements for supervision of a provisional licensee, including the qualifications and responsibilities of the supervising nurse; and (v) provisions for expiration and renewal of a provisional license.

At the request of the office of the Secretary of Health and Human Resources, the board reconsidered the regulation pertaining to credit for clinical experience for graduates of Excelsior College or any similar nursing education program. In the reconsidered emergency regulations, the board agreed to grant an applicant up to 100 hours of credit towards the 500-hour clinical practice requirement if he has successfully completed a nursing education program that:

1. Requires students to pass competency-based assessments of nursing knowledge as well as a summative performance assessment of clinical competency that has been evaluated by the American Council on Education or any other board-approved organization; and
2. Has a passage rate for first-time test takers on the NCLEX that is not less than 80%, calculated on the cumulative results of the past four quarters of all graduates in each calendar year regardless of where the graduate is seeking licensure.

18VAC90-20-215. Provisional licensure of applicants for licensure as registered nurses.

A. Pursuant to § 54.1-3017.1 of the Code of Virginia, the board may issue a provisional license to an applicant for the purpose of meeting the 500 hours of supervised, direct (hands-on) client care required of an approved registered nurse education program.

B. Such applicants for provisional licensure shall submit:

1. A completed application for licensure by examination and fee;
2. Documentation that the applicant has successfully completed a nursing education program; and
3. Documentation of passage of NCLEX in accordance with 18VAC90-20-190.

C. Requirements for hours of direct client care with a provisional license.

1. To qualify for licensure as a registered nurse, direct, hands-on hours of supervised clinical experience shall include the areas of adult medical/surgical nursing, geriatric nursing, maternal/infant (obstetrics, gynecology, neonatal) nursing, mental health/psychiatric nursing, nursing fundamentals, and pediatric nursing. Supervised clinical hours may be obtained in employment in the role of a registered nurse or without compensation for the purpose of meeting these requirements.

2. Hours of direct, hands-on clinical experience obtained as part of the applicant's nursing education program and noted on the official transcript shall be counted towards the minimum of 500 hours and in the applicable areas of clinical practice.

3. For applicants with a current, active license as an LPN, 150 hours of credit shall be counted towards the 500-hour requirement.

4. Up to 100 hours of credit may be applied towards the 500-hour requirement for applicants who have successfully completed a nursing education program that:

a. Requires students to pass competency-based assessments of nursing knowledge as well as a summative performance assessment of clinical competency that has been evaluated by the American Council on Education or any other board-approved organization; and

b. Has a passage rate for first-time test takers on the NCLEX that is not less than 80%, calculated on the cumulative results of the past four quarters of all graduates in each calendar year regardless of where the graduate is seeking licensure.

5. An applicant for licensure shall submit verification from a supervisor of the number of hours of direct client care and the areas in which clinical experiences in the role of a registered nurse were obtained.

D. Requirements for supervision of a provisional licensee.

1. The supervisor shall be onsite and physically present in the unit where the provisional licensee is providing clinical care of clients.

2. In the supervision of provisional licensees in the clinical setting, the ratio shall not exceed two provisional licensees to one supervisor at any given time.

3. Licensed registered nurses providing supervision for a provisional licensee shall:

a. Notify the board of the intent to provide supervision for a provisional licensee on a form provided by the board;

b. Hold an active, unrestricted license or multistate licensure privilege and have at least two years of active clinical practice as a registered nurse prior to acting as a supervisor;

Regulations

c. Be responsible and accountable for the assignment of clients and tasks based on their assessment and evaluation of the supervisee's clinical knowledge and skills;

d. Be required to monitor clinical performance and intervene if necessary for the safety and protection of the clients; and

e. Document on a form provided by the board the frequency and nature of the supervision of provisional licensees to verify completion of hours of clinical experience.

E. The provisional status of the licensee shall be disclosed to the client prior to treatment and shall be indicated on identification worn by the provisional licensee.

F. All provisional licenses shall expire six months from the date of issuance and may be renewed for an additional six months. Renewal of a provisional license beyond the limit of 12 months shall be for good cause shown and shall be approved by the board. A request for extension of a provisional license beyond 12 months shall be made at least 30 days prior to its expiration.

NOTICE: The following forms used in administering the regulation were filed by the agency. The forms are not being published; however, online users of this issue of the Virginia Register of Regulations may click on the name of a form with a hyperlink to access it. The forms are also available from the agency contact or may be viewed at the Office of the Registrar of Regulations, General Assembly Building, 2nd Floor, Richmond, Virginia 23219.

FORMS (18VAC90-20)

[Application for Licensure by Endorsement -- Registered Nurse \(rev. 5/11\)](#)

[Instructions for Licensure by Endorsement -- Registered Nurse \(rev. 5/11\)](#)

[Instructions for Licensure by Endorsement -- Licensed Practical Nurse \(rev. 5/11\)](#)

[Application for Licensure by Endorsement -- Licensed Practical Nurse \(rev. 6/11\)](#)

[Verification of Clinical Practice -- Licensure by Endorsement \(rev. 1/10\)](#)

[Instructions and Application for Licensure by Examination for Registered Nurses \(rev. 8/11\)](#)

[Instructions and Application for Licensure by Examination - Licensed Practical Nurse \(rev. 8/11\)](#)

[Instructions and Application for Licensure by Repeat Examination for Registered Nurse \(rev. 8/11\)](#)

[Instructions and Application for Licensure by Repeat Examination for Licensed Practical Nurse \(rev. 8/11\)](#)

[Instructions and Application for Licensure by Examination for Licensed Practical Nurses Educated in Other Countries \(rev. 6/11\)](#)

[Instructions and Application for Licensure by Examination for Registered Nurses Educated in Other Countries \(rev. 6/11\)](#)

[Declaration of Primary State of Residency for Purposes of the Nurse Licensure Compact \(rev. 6/11\)](#)

[Instructions for Application for Reinstatement -- Registered Nurse \(rev. 10/10\)](#)

[Application for Reinstatement -- Registered Nurse \(rev. 6/11\)](#)

[Instructions for Application for Reinstatement -- Licensed Practical Nurse \(rev. 2/10\)](#)

[Application for Reinstatement of License as a Licensed Practical Nurse \(rev. 6/11\)](#)

[Instructions and Application for Reinstatement of License as a Registered Nurse Following Suspension or Revocation \(rev. 6/11\)](#)

[Instructions and Application for Reinstatement of License as a Licensed Practical Nurse Following Suspension or Revocation \(rev. 6/11\)](#)

[License Verification Form \(rev. 10/09\)](#)

[Procedure \(rev. 3/10\) and Application for Registration as a Clinical Nurse Specialist \(rev. 6/11\)](#)

[Application for Reinstatement of Registration as a Clinical Nurse Specialist \(rev. 6/11\)](#)

[Application to Establish a Nursing Education Program \(rev. 6/11\)](#)

[Agenda and Survey Visit Report -- Registered Nurse Education Program \(rev. 4/08\)](#)

[Agenda and Survey Visit Report -- Practical Nurse Education Program \(rev. 4/08\)](#)

[NCLEX Survey Visit Report \(rev. 4/08\)](#)

[Application for Registration for Volunteer Practice \(rev. 7/07\)](#)

[Sponsor Certification for Volunteer Registration \(rev. 8/08\)](#)

[Verification of Supervised Clinical Practice -- Registered Nurse Provisional License \(undated\)](#)

[Notification of Intent to Supervise Clinical Practice -- Registered Nurse Provisional License \(undated\)](#)

VA.R. Doc. No. R13-2989; Filed July 9, 2013, 11:17 a.m.

◆ ————— ◆

TITLE 24. TRANSPORTATION AND MOTOR VEHICLES

DEPARTMENT OF MOTOR VEHICLES

Final Regulation

REGISTRAR'S NOTICE: The Department of Motor Vehicles is claiming an exemption from the Administrative Process Act in accordance with § 2.2-4006 A 4 a of the Code of

Virginia, which excludes regulations that are necessary to conform to changes in Virginia statutory law where no agency discretion is involved. The Department of Motor Vehicles will receive, consider, and respond to petitions from any interested person at any time with respect to reconsideration or revision.

Title of Regulation: **24VAC20-60. Virginia Commercial Driver's License Regulations (repealing 24VAC20-60-10 through 24VAC20-60-190).**

Statutory Authority: §§ 46.2-203 and 46.2-341.5 of the Code of Virginia.

Effective Date: August 29, 2013.

Agency Contact: Barbara S. Klotz, Legislative Services Manager, Department of Motor Vehicles, P.O. Box 27412, Richmond, Virginia 23269-0001, telephone (804) 367-8171, FAX (804) 367-6631, TTY (800) 272-9268, or email barbara.klotz@dmv.virginia.gov.

Summary:

Chapters 165 and 582 of the 2013 Acts of Assembly codified these regulations in the Code of Virginia. Therefore, the current regulations are redundant and no longer needed.

VA.R. Doc. No. R13-3802; Filed July 3, 2013, 3:23 p.m.

Fast-Track Regulation

Title of Regulation: **24VAC20-90. Evidence Required to Permit Registration or Reregistration of Vehicles for Which Proof of Tax Payment and of State Corporation Commission Registration is Required (repealing 24VAC20-90-10, 24VAC20-90-20, 24VAC20-90-30).**

Statutory Authority: §§ 46.2-203 and 46.2-649 of the Code of Virginia.

Public Hearing Information: No public hearings are scheduled.

Public Comment Deadline: August 28, 2013.

Effective Date: September 27, 2013.

Agency Contact: Barbara S. Klotz, Legislative Services Manager, Department of Motor Vehicles, P.O. Box 27412, Richmond, VA 23269-0001, telephone (804) 367-8171, FAX (804) 367-6631, TTY (800) 272-9268, or email barbara.klotz@dmv.virginia.gov.

Basis: Pursuant to § 46.2-203 of the Code of Virginia the Commissioner of the Department of Motor Vehicles (DMV) has general authority to adopt reasonable regulations necessary to carryout the laws administered by DMV. However, specific authority to promulgate regulations regarding evidence of payment of taxes was removed from § 46.2-649 of the Code of Virginia by Chapter 226 of the 2013 Acts of Assembly.

Purpose: This regulatory action is necessary to eliminate DMV's regulations entitled Evidence Required to Permit Registration or Reregistration of Vehicles for which Proof of

Tax Payment and of State Corporation Commission Registration Is Required (24VAC20-90). Specific authority to regulate was removed from the Code of Virginia by Chapter 226 of the 2013 Acts of Assembly. The regulatory requirements are codified in the Code of Virginia. The regulations are redundant.

Rationale for Using Fast-Track Process: Repeal of this regulation is not anticipated to be controversial since the regulations are no longer authorized and are redundant.

Substance: There are no substantive changes. The regulation is being repealed.

Issues: The advantage for the public, the agency, and the Commonwealth is the repeal of redundant and unnecessary regulations. In addition, it is advantageous to the agency not to have to go through a lengthy regulatory process when the agency decides to add new methods and types of evidence that may be used to prove that all local, state, and federal taxes have been paid. The agency will work with local commissioners of revenue and directors of finance, and with appropriate federal officials on the kinds of evidence that will be accepted, especially as technology permits more options for providing evidence or payment. This flexibility will also be advantageous to the public and localities. There is no disadvantage for the public, the agency, and the Commonwealth in repealing this regulation.

Department of Planning and Budget's Economic Impact Analysis:

Summary of the Proposed Amendments to Regulation. The Commissioner of the Department of Motor Vehicles proposes to repeal this regulation.

Result of Analysis. The proposed change will have no significant impact.

Estimated Economic Impact. Code of Virginia 46.2-649 states the following:

A. Before the Commissioner registers or reregisters any motor vehicle, trailer, or semitrailer under 46.2-697, 46.2-698, 46.2-700 or 46.2-703, the applicant shall furnish evidence satisfactory to the Commissioner that all state, local, and federal taxes levied on that motor vehicle, trailer, or semitrailer have been paid and that the motor vehicle, trailer, or semitrailer either (i) is registered with the Department as required by law, or (ii) is not required so to register.

Prior to the 2013 Acts of Assembly, the next subsection of 46.2-649 was as follows:

B. The Commissioner, in consultation with local commissioners of the revenue and directors of finance, and with appropriate federal officials, by regulation shall provide for the kinds of evidence required to satisfy the provisions of subsection A of this section.

Chapter 226 of the 2013 Acts of Assembly removed the words by regulation from the above subsection. Consequently, the Commissioner proposes to repeal this

Regulations

regulation. As still required by the Code, the Commissioner will continue to consult with local commissioners of revenue and directors of finance, and with appropriate federal officials on the kinds of evidence that can be used to prove that all local, state, and federal taxes have been paid.

The current regulations essentially indicate that a receipt from the relevant taxing authority would serve as proof. Presumably this will continue to be the case without these regulations. Thus, the proposed repeal of these regulations will not have a significant impact.

Businesses and Entities Affected. The proposed repeal will not significantly affect any business or entity. The subject matter of the regulations concerns individuals seeking to register a motor vehicle, trailer, or semitrailer.

Localities Particularly Affected. The proposed repeal does not disproportionately affect particular localities.

Projected Impact on Employment. The proposed repeal is unlikely to affect employment.

Effects on the Use and Value of Private Property. The proposed repeal is unlikely to significantly affect the use and value of private property.

Small Businesses: Costs and Other Effects. The proposed repeal is unlikely to significantly affect small businesses.

Small Businesses: Alternative Method that Minimizes Adverse Impact. The proposed repeal is unlikely to significantly affect small businesses.

Real Estate Development Costs. The proposed repeal is unlikely to affect real estate development costs.

Legal Mandate. The Department of Planning and Budget (DPB) has analyzed the economic impact of this proposed regulation in accordance with § 2.2-4007.04 of the Administrative Process Act and Executive Order Number 14 (10). Section 2.2-4007.04 requires that such economic impact analyses include, but need not be limited to, a determination of the public benefit, the projected number of businesses or other entities to whom the regulation would apply, the identity of any localities and types of businesses or other entities particularly affected, the projected number of persons and employment positions to be affected, the projected costs to affected businesses or entities to implement or comply with the regulation, and the impact on the use and value of private property. Further, if the proposed regulation has an adverse effect on small businesses, § 2.2-4007.04 requires that such economic impact analyses include (i) an identification and estimate of the number of small businesses subject to the regulation; (ii) the projected reporting, recordkeeping, and other administrative costs required for small businesses to comply with the regulation, including the type of professional skills necessary for preparing required reports and other documents; (iii) a statement of the probable effect of the regulation on affected small businesses; and (iv) a description of any less intrusive or less costly alternative methods of achieving the purpose of the regulation. The analysis

presented above represents DPB's best estimate of these economic impacts.

Agency's Response to Economic Impact Analysis: The Virginia Department of Motor Vehicles concurs with the analysis of the Department of Planning and Budget.

Summary:

Chapter 226 of the 2013 Acts of Assembly removes the authority of the Commissioner of the Department of Motor Vehicles to promulgate regulations specifically dealing with evidence of payment of taxes and of registration with the department. Therefore, this chapter is repealed.

VA.R. Doc. No. R13-3686; Filed June 28, 2013, 4:19 p.m.

GENERAL NOTICES/ERRATA

DEPARTMENT OF ENVIRONMENTAL QUALITY

Water Quality Total Maximum Daily Load Study of the Maury River and Tributaries

Public meetings: Two meetings will be hosted at two convenient locations within the Maury watershed. The first will be held Tuesday, August 6, 2013, at 7 p.m. at the Buena Vista City Council Chambers at 2039 Sycamore Avenue, Buena Vista, VA 24416. The second will be held Wednesday, August 7, 2013, at 7 p.m. at the Effinger Volunteer Fire Department, 2824 Collierstown Road, Lexington, VA 24450. All meetings are open to the public and all are welcome.

Purpose of notice: The Department of Environmental Quality (DEQ), its contractors, Virginia Tech's Biological Systems Engineering Department, and the Technical Advisory Committee, made up of local landowners and interested parties, will present the development of a water quality study known as a total maximum daily load (TMDL) for the Maury River and its tributaries, including Cedar Creek, North Fork and South Fork Buffalo Creek, the mainstem of Buffalo Creek, and Colliers Creek. This is an opportunity for local residents to learn more about the water quality study and find out how they can help. A public comment period will follow the meetings (August 6, 2013, through September 6, 2013).

Meeting description: Two public meetings will be held to introduce to the local community the water quality improvement process in Virginia, known as the TMDL Process, review the work of the Technical Advisory Committee, solicit their input, and review the next steps. Section 303(d) of the Clean Water Act and § 62.1-44.19:7 C of the Code of Virginia require DEQ to develop TMDLs for pollutants responsible for each impaired water contained in Virginia's 303(d) TMDL Priority List and Report.

Description of study: Several streams in the Maury River watershed do not meet Virginia's water quality standards due to excessive bacteria and have been placed on the 2006, 2008, and 2010 303(d) TMDL Priority List and Report as impaired. The bacteria standard preserves the "Primary Contact (recreational or swimming)" designated use for Virginia waterways. Excessive bacteria levels may pose a threat to human health. This water quality study reports on the sources of bacterial contamination and recommends reductions to meet TMDLs for the impaired waters. A TMDL is the total amount of a pollutant a water body can contain and still meet water quality standards. To restore water quality, bacterial levels need to be reduced to the TMDL amount. Virginia agencies are working to identify sources of bacterial contamination in the Mary River and its tributaries, including the following waterways:

Stream	County	Length (miles)	Impairment
Colliers Creek	Rockbridge	13.77 mi	Bacteria (E. coli)
North Fork Buffalo Creek	Rockbridge	7.28 mi	
South Fork Buffalo Creek	Rockbridge	13.24 mi	
Buffalo Creek	Rockbridge	15.51 mi	
Maury River	Buena Vista and Rockbridge	12.84 mi	
Cedar Creek	Rockbridge	11.49	

In addition, Colliers Creek does not host a healthy and diverse population of aquatic life, and subsequently was listed as impaired for the "General Benthic (Aquatic life)" water quality standard. This water quality TMDL study reviewed all data collected and determined the cause of the benthic impairment as sediment through a weight of evidence approach. Reductions and a TMDL for sediment were developed.

Stream	County	Length (miles)	Impairment
Colliers Creek	Rockbridge	13.77 mi	Aquatic Life

How to comment: The public comment period for these public meetings will end on September 6, 2013. Written comments should include the name, address, and telephone number of the person submitting the comments and should be sent to: Tara Sieber, Department of Environmental Quality, Valley Regional Office, P.O. Box 3000, Harrisonburg, VA 22801, telephone (540) 574-7870, FAX (540) 574-7878, or email tara.sieber@deq.virginia.gov.

Total Maximum Daily Load Studies in Red Bank Creek and a Portion of Machipongo River, Located in Northampton and Accomack Counties

The Virginia Department of Environmental Quality (DEQ) will host a public meeting on water quality studies for Red Bank Creek and a portion of Machipongo River, located in Northampton and Accomack Counties, on Thursday August 15, 2013.

The meeting will start at 6:30 p.m. at the Northampton Free Library located at 7745 Seaside Road, Nassawadox, VA

General Notices/Errata

23413. The purpose of the meeting is to provide information and discuss the final total maximum daily load (TMDL) studies with community members and local government.

Red Bank Creek (Enterococci, E. coli, Fecal coliform, Dissolved oxygen), and Machipongo River (Enterococci), were identified in Virginia's 2010 Water Quality Assessment and Integrated Report as impaired due to violations of the State's water quality standards for recreation bacteria, dissolved oxygen, and shellfish consumption bacteria and do not support the designated uses. The Red Bank Creek watershed includes both riverine and tidal portions of the creek. The Machipongo River watershed only includes the area of the stream covered from the end of tidal waters downstream to 0.5 mile south of Route 182.

Section 303(d) of the Clean Water Act and § 62.1-44.19:7 C of the Code of Virginia, require DEQ to develop TMDLs for pollutants responsible for each impaired water contained in Virginia's 303(d) TMDL Priority List and Report and subsequent Water Quality Assessment Reports.

During the study, DEQ developed a TMDL for the impaired waters. A TMDL is the total amount of a pollutant a water body can contain and still meet water quality standards. To restore water quality, pollutant levels have to be reduced to the TMDL amount. The Virginia Department of Environmental Quality and the Virginia Department of Health are working to identify the sources of pollution in the watersheds of these streams.

The public comment period on materials presented at this meeting will extend from August 9, 2013, through September 9, 2013. For additional information or to submit comments, contact Jennifer Howell, Department of Environmental Quality, Tidewater Regional Office, 5636 Southern Boulevard, Virginia Beach, VA 23462, telephone (757) 518-2111, or email jennifer.howell@deq.virginia.gov.

Additional information is also available on the DEQ website at www.deq.virginia.gov/tmdl.

STATE LOTTERY DEPARTMENT

Director's Orders

The following Director's Orders of the State Lottery Department were filed with the Virginia Registrar of Regulations on July 9, 2013. The orders may be viewed at the State Lottery Department, 900 East Main Street, Richmond, VA, or at the office of the Registrar of Regulations, 910 Capitol Street, 2nd Floor, Richmond, VA.

Director's Order Number Fifty-Four (13)

"Redskins Retailer Incentive Promotion" Virginia Lottery Retailer Incentive Program Requirements (effective June 25, 2013)

Director's Order Number Fifty-Five (13)

"25 Grand Years Retailer Incentive Promotion" Virginia Lottery Retailer Incentive Program Requirements (effective June 25, 2013)

Director's Order Number Sixty-One (13)

Virginia Lottery's "Play For Keeps Sweeps" Final Rules for Operation (effective June 27, 2013)

DEPARTMENT OF MOTOR VEHICLES

Small Business Impact Review - Report of Findings

Pursuant to § 2.2-4007.1 of the Code of Virginia, the Department of Motor Vehicles (DMV) has conducted a small business impact review of **24VAC20-110, T&M Vehicle, Trailer, and Motorcycle Dealer Advertising Practices and Enforcement Regulations**, and determined that this regulation should be retained in its current form. DMV is publishing its report of findings dated May 31, 2013, to support this decision in accordance with § 2.2-4007.1 G of the Code of Virginia.

DMV did not receive any comments during the comment period indicating a need to repeal or amend the regulation to minimize the economic impact on small businesses. DMV informally solicited comments from stakeholders directly prior to publication of the Notice of Periodic Review. The informal solicitation of comments focused on whether there is a continued need for the regulation and to ensure that the regulation minimizes the economic impact on small businesses. It is always DMV's goal to provide stakeholders with ample opportunity for input so the regulation was sent to stakeholders well in advance of the beginning of the review to obtain input. DMV received one comment during the informal solicitation for comments; however, the commenter did not address economic impact on his business.

DMV has determined to retain the regulation at this time pending the Motor Vehicle Dealer Board's revisions to its regulation. DMV has not received any complaints regarding the existing regulation. DMV has determined that the regulation is not overly complex and mirrors the Code of Virginia. DMV has also determined that the regulation does not overlap, or conflict with federal or state law or regulation. Many items within the regulation are included in the statutes. DMV considered the degree to which technology, economic conditions, or other factors have changed in the area affected by the regulation, and has determined that no changes are necessary at this time

Contact Information: Melissa K. Velazquez, Senior Policy Analyst, 2300 West Broad Street, Richmond, VA 23269, telephone (804) 367-1844, FAX (804) 367-4336, or email melissa.velazquez@dmv.virginia.gov.

STATE WATER CONTROL BOARD

Proposed Consent Order for ASB Greenworld, Inc.

An enforcement action has been proposed for ASB Greenworld, Inc. for alleged violations at the facility located at 643 Airport Road, Mattaponi, Virginia. The consent order requires corrective action and a civil charge. A description of the proposed action is available at the Department of Environmental Quality office named below or online at www.deq.virginia.gov. Frank Lupini will accept comments by email at frank.lupini@deq.virginia.gov, FAX (804) 527-5106, or postal mail to Department of Environmental Quality, Piedmont Regional Office, 4949-A Cox Road, Glen Allen, VA 23060, from July 29, 2013, to August 29, 2013.

Proposed Consent Order for the Town of Coeburn

An enforcement action has been proposed for the Town of Coeburn for violations in Wise County. The proposed consent order addresses violations of the State Water Control Law and VPDES Permit No. VA0061743 at the Sheffield Acres Sewage Treatment Plant. A description of the proposed action is available at the Department of Environmental Quality office named below or online at www.deq.virginia.gov. Ralph T. Hilt will accept comments by email at ralph.hilt@deq.virginia.gov, FAX (276) 676-4899, or postal mail to Department of Environmental Quality, Southwest Regional Office, 355-A Deadmore Street, Abingdon, VA 24210, from July 30, 2013, to August 28, 2013.

VIRGINIA CODE COMMISSION

Notice to State Agencies

Contact Information: *Mailing Address:* Virginia Code Commission, General Assembly Building, 201 North 9th Street, 2nd Floor, Richmond, VA 23219; *Telephone:* Voice (804) 786-3591; FAX (804) 692-0625; *Email:* varegs@dls.virginia.gov.

Meeting Notices: Section 2.2-3707 C of the Code of Virginia requires state agencies to post meeting notices on their websites and on the Commonwealth Calendar at <http://www.virginia.gov/connect/commonwealth-calendar>.

Cumulative Table of Virginia Administrative Code Sections Adopted, Amended, or Repealed: A table listing regulation sections that have been amended, added, or repealed in the *Virginia Register of Regulations* since the regulations were originally published or last supplemented in the print version of the Virginia Administrative Code is available at <http://register.dls.virginia.gov/documents/cumulatab.pdf>.

Filing Material for Publication in the Virginia Register of Regulations: Agencies use the Regulation Information System (RIS) to file regulations and related items for publication in the *Virginia Register of Regulations*. The Registrar's office works closely with the Department of

Planning and Budget (DPB) to coordinate the system with the Virginia Regulatory Town Hall. RIS and Town Hall complement and enhance one another by sharing pertinent regulatory information.

ERRATA

STATE CORPORATION COMMISSION

Title of Regulation: **21VAC5-80. Investment Advisors.**

Publication: 29:20 VA.R. 2507 June 3, 2013

Correction to Final Regulation:

Page 2507, 21VAC5-80-170 F, clause (i), beginning on line 5:

Immediately following "(i)" replace "the" with "[the]"

After "advisor" replace "representative" with "[representative representatives]"

Before "in compliance" replace "is" with "are"

After "statutory" change "provision" to "[provision provisions]"

VA.R. Doc. No. R13-3073; Filed July 10, 2013, 9:47 a.m.

